

TEM®



2017
Fiyat Listesi



İÇİNDEKİLER

MONOFAZE FİŞ & PRİZLER	2
KAUÇUK FİŞ & PRİZLER	2-3
DÖŞEME ALTI / KANAL ÜSTÜ PRİZLER	4-5
DÖŞEME ALTI / KANAL ÜSTÜ TELEFON & DATA KONNEKTÖRLERİ / KEYSTONE KAPAKLARI	6
MULTİMEDYA SOKETLER	7
BİLGİSAYAR SOKETLERİ	8
CEE NORM FİŞ & PRİZLER	9-19
ALÜMİNYUM GRUP PRİZLER	20-23
MASA İÇİ PRİZ GRUPLARI - LEDLİ GRUP PRİZLER	24-28
DAHİLİ PRİZ KUTULARI	29
KOMBİNASYON KUTULARI	30-34
TERMOPLASTİK BUATLAR	35
KABLO MAKARALARI	36-38
TAŞIYICI AYAKLAR	39
PLASTİK DAĞITIM PANOLARI	40-46
PANO AKSESUARLARI	47
POLYESTER PANOLAR	48-49
İZOLATÖRLER	50-51
BALADOZ - KABLOLAR	52

16A

2P + \perp MONOFAZE SCHUKO TİP PRİZLER

200 - 250V ~

TEK GİRİŞLİ IP44

ÇİFT GİRİŞLİ IP54

PANO PRİZİ
6,30.-TL

PANO PRİZİ - UPS
7,30.-TL

PANO PRİZİ
6,30.-TL

PANO PRİZİ - UPS
7,30.-TL



216.216.150



216.316.150

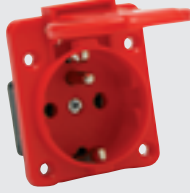

216.216.160



216.316.160



* FARKLI RENK SEÇENEKLERİMİZ MEVCUTTUR.



16A

2P + \perp MONOFAZE PRİZLER

IP44

200 - 250V ~

EĞİK MAKİNE PRİZİ
11,00.-TL

KİLİTLİ KAPAKLI EĞİK
MAKİNE PRİZİ
15,00.-TL

MAKİNE PRİZİ
8,00.-TL

DUVAR PRİZİ DİK KASALI
11,50.-TL

DUVAR PRİZİ
EĞİK KASALI
12,00.-TL

DUVAR PRİZİ EĞİK KASALI
MONOFAZE PRİZLİ
18,50.-TL



440.116.160



670.116.160



215.116.150



215.116.151

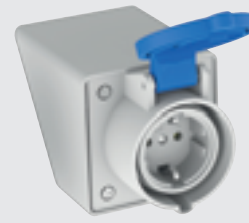

215.116.152



215.116.153



16A

2P + \perp MONOFAZE KAUÇUK FİŞ & PRİZLER

200 - 250V ~



215.116.101

DUVAR PRİZİ

9,00.-TL



215.116.200

SEYYAR PRİZ

7,15.-TL



215.116.301



215.116.300



215.116.320

215.116.301 DÜZ FİŞ 5,80.-TL

215.116.300 DÜZ FİŞ 5,50.-TL

215.316.300 DÜZ FİŞ UPS 6,30.-TL

215.116.320 EĞİK FİŞ 6,40.-TL

215.316.320 EĞİK FİŞ UPS 7,00.-TL



215.116.102

İKİLİ GRUP

15,80.-TL



215.116.103

ÜÇLÜ GRUP

18,00.-TL



215.116.104

DÖRTLÜ GRUP

24,50.-TL

25A**KAUÇUK TRİFAZE FİŞ & PRİZLER 4x25A****380 - 415V ~**FİŞ
7,90.-TL

540.425.300

SEYYAR PRİZ
12,00.-TL

540.425.200

DUVAR PRİZİ
KLEMENSLİ
14,00.-TL

540.425.110

1Ad. 3x25A+
1Ad. 1x16A GRUP PRİZ
27,00.-TL

540.425.111

2Ad. 3x25A+
1Ad. 1x16A GRUP PRİZ
36,50.-TL

540.425.121

1Ad. 3x25A+
2Ad. 1x16A GRUP PRİZ
34,00.-TL

540.425.112

3x25A GRUP PRİZ
39,00.-TL

540.425.130

PANO PRİZİ
10,20.-TL

540.425.150

DUVAR PRİZİ DİK KASALI
13,50.-TL

540.425.151

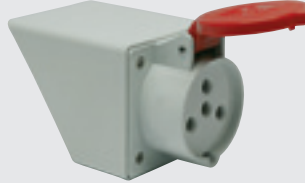
DUVAR PRİZİ EĞİK KASALI
15,00.-TL

540.425.152

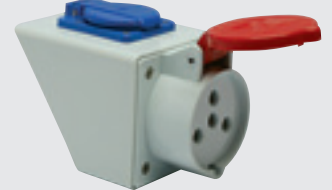
DUVAR PRİZİ EĞİK KASALI
MONOFAZE PRİZLİ
21,00.-TL

540.425.153

**16A****KAUÇUK TRİFAZE PRİZLER 3x16 A****IP44****380 - 415V ~**FİŞ
13,50.-TL

544.316.300

PANO PRİZİ
11,00.-TL

544.316.150

DUVAR PRİZİ
DİK KASALI
14,00.-TL

544.316.151

DUVAR PRİZİ
EĞİK KASALI
16,50.-TL

544.316.152

DUVAR PRİZİ
EĞİK KASALI MONOFAZE PRİZLİ
23,00.-TL

544.316.153

**32A****KAUÇUK TRİFAZE PRİZLER 3x32 A****IP44****380 - 415V ~**FİŞ
20,00.-TL

544.332.300

PANO PRİZİ
12,50.-TL

544.332.150

DUVAR PRİZİ
DİK KASALI
16,00.-TL

544.332.151

DUVAR PRİZİ
EĞİK KASALI
18,00.-TL

544.332.152

DUVAR PRİZİ
EĞİK KASALI MONOFAZE PRİZLİ
24,80.-TL

544.332.153



16A

DÖŞEME ALTI / KANAL ÜSTÜ ŞEBEKE PRİZLERİ 2P+⏚

200 - 250V~

ŞEBEKE PRİZİ
6,00.-TL



250.216.150

ŞEBEKE PRİZİ
6,00.-TL



245.216.150

ŞEBEKE PRİZİ 45°
6,00.-TL



246.216.150

ŞEBEKE PRİZİ
6,00.-TL



345.216.150

ŞEBEKE PRİZİ 45°
6,00.-TL

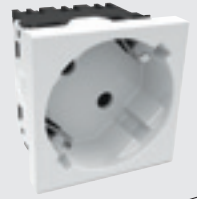

346.216.150



16A

DÖŞEME ALTI / KANAL ÜSTÜ UPS PRİZLERİ 2P+⏚

200 - 250V~

UPS PRİZİ
7,20.-TL



250.316.150

UPS PRİZİ
7,20.-TL



245.316.150

UPS PRİZİ 45°
7,20.-TL



246.316.150

UPS PRİZİ
7,20.-TL



345.316.150

UPS PRİZİ 45°
7,20.-TL



346.316.150

FRANSIZ STANDART PRİZİ
8,00.-TL



247.216.150



45x45mm ULUSLARARASI FİŞ & PRİZLER

İNGİLİZ FİŞİ
19,50.-TL



721.130.300



İNGİLİZ PRİZİ
16,00.-TL



721.130.150



AMERİKAN PRİZİ
19,00.-TL



721.160.150



UNIVERSAL PRİZ
22,00.-TL



721.170.150



TV PRİZLERİ

TV PRİZİ
15,00.-TL

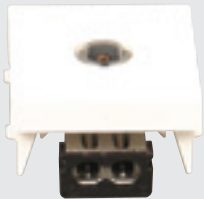

723.000.150

TV PRİZİ ERKEK Ø9.52mm
15,00.-TL

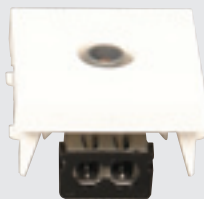

723.000.300

TV UYDU PRİZİ
17,00.-TL

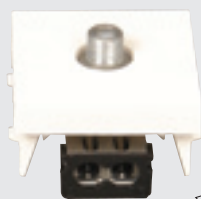

723.000.400



16A RAY PRİZİ

200 - 250V~



217.216.170	ŞEBEKE	13,30.-TL
217.316.170	UPS	14,50.-TL

LEDLİ

217.216.171	ŞEBEKE	16,00.-TL
217.316.171	UPS	17,20.-TL



ON - OFF ANAHTARLAR

22.5x45mm
ANAHTAR 10A



45x45mm
ANAHTAR-TEKİLİ 16A



45x45mm
ANAHTAR-ÇİFTLİ 2x10A



22.5x45mm
ANAHTAR 16A

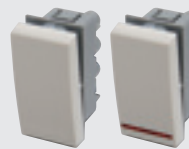

45x45mm
ANAHTAR ÇİFTLİ 2x16A



722.225.110	İŞIKLI	6,30.-TL
722.225.010	İŞIKSIZ	5,80.-TL

722.045.112	İŞIKLI	8,00.-TL
722.045.012	İŞIKSIZ	7,50.-TL

722.045.111	İŞIKLI	10,50.-TL
722.045.011	İŞIKSIZ	10,00.-TL

722.225.112	İŞIKLI	11,50.-TL
722.225.021	İŞIKSIZ	10,50.-TL

722.045.122	İŞIKLI	15,50.-TL
722.045.022	İŞIKSIZ	14,50.-TL

* Şebeke ve UPS prizlerinde ÇOCUK EMNİYETLİ için priz başına fiyat farkı 1,00.-TL'dir.

16A

2P + \perp ŞEBEKE TİP BLOK PRİZLER

200 - 250V ~



	AÇIKLAMA	KOD	B. FİYAT	ÇOCUK EMNİYETLİ KOD	B. FİYAT
KABLOLU	2'Lİ ŞEBEKE PRİZİ	300.216.002	14,00.-TL	300.216.102	16,00.-TL
	3'LÜ ŞEBEKE PRİZİ	300.216.003	17,50.-TL	300.216.103	20,50.-TL
	4'LÜ ŞEBEKE PRİZİ	300.216.004	22,00.-TL	300.216.104	26,00.-TL
KLEMENSLİ	2'Lİ ŞEBEKE PRİZİ	301.216.002	14,50.-TL	301.216.102	16,50.-TL
	3'LÜ ŞEBEKE PRİZİ	301.216.003	18,50.-TL	301.216.103	21,50.-TL
	4'LÜ ŞEBEKE PRİZİ	301.216.004	24,50.-TL	301.216.104	28,50.-TL
ÇİFT KLEMENSLİ	2'Lİ ŞEBEKE PRİZİ	302.216.002	21,00.-TL	302.216.102	23,00.-TL
	3'LÜ ŞEBEKE PRİZİ	302.216.003	24,50.-TL	302.216.103	27,50.-TL
	4'LÜ ŞEBEKE PRİZİ	302.216.004	30,80.-TL	302.216.104	34,80.-TL

16A

2P + \perp UPS TİP BLOK PRİZLER

200 - 250V ~

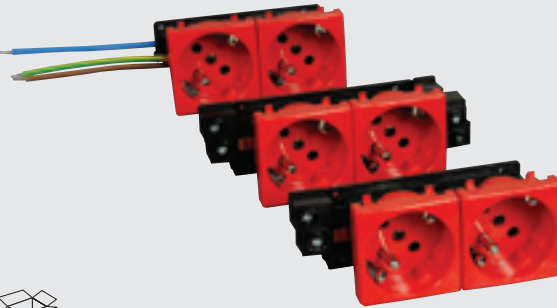

	AÇIKLAMA	KOD	B. FİYAT	ÇOCUK EMNİYETLİ KOD	B. FİYAT
KABLOLU	2'Lİ UPS PRİZİ	300.316.002	16,20.-TL	300.316.102	18,20.-TL
	3'LÜ UPS PRİZİ	300.316.003	21,00.-TL	300.316.103	24,00.-TL
	4'LÜ UPS PRİZİ	300.316.004	26,50.-TL	300.316.104	30,50.-TL
KLEMENSLİ	2'Lİ UPS PRİZİ	301.316.002	17,00.-TL	301.316.102	19,00.-TL
	3'LÜ UPS PRİZİ	301.316.003	22,50.-TL	301.316.103	25,50.-TL
	4'LÜ UPS PRİZİ	301.316.004	29,50.-TL	301.316.104	33,50.-TL
ÇİFT KLEMENSLİ	2'Lİ UPS PRİZİ	302.316.002	22,50.-TL	302.316.102	24,50.-TL
	3'LÜ UPS PRİZİ	302.316.003	27,00.-TL	302.316.103	30,00.-TL
	4'LÜ UPS PRİZİ	302.316.004	34,00.-TL	302.316.104	38,00.-TL

16A

2P + \perp FRANŞIZ TİP BLOK PRİZLER

200 - 250V ~

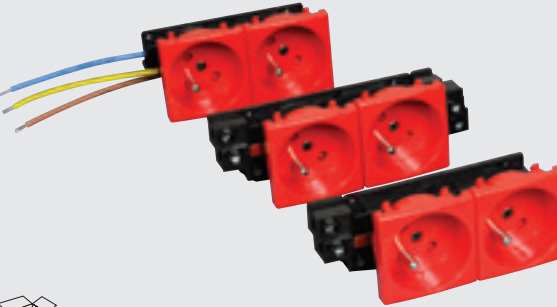

	KOD	AÇIKLAMA	B. FİYAT
KABLOLU	310.316.102	2'Lİ FRANŞIZ PRİZİ	20,00.-TL
	310.316.103	3'LÜ FRANŞIZ PRİZİ	25,50.-TL
	310.316.104	4'LÜ FRANŞIZ PRİZİ	33,50.-TL
KLEMENSLİ	311.316.102	2'Lİ FRANŞIZ PRİZİ	21,00.-TL
	311.316.103	3'LÜ FRANŞIZ PRİZİ	27,00.-TL
	311.316.104	4'LÜ FRANŞIZ PRİZİ	35,00.-TL
ÇİFT KLEMENSLİ	312.316.102	2'Lİ FRANŞIZ PRİZİ	27,00.-TL
	312.316.103	3'LÜ FRANŞIZ PRİZİ	30,00.-TL
	312.316.104	4'LÜ FRANŞIZ PRİZİ	38,00.-TL

13A

2P + \perp İNGİLİZ TİP BLOK PRİZLER

200 - 250V ~

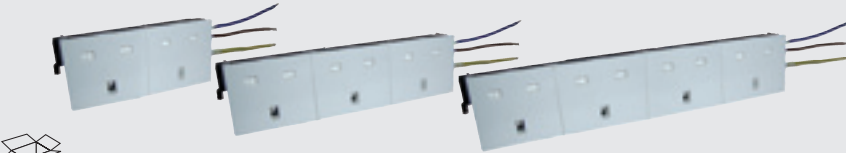

KOD	AÇIKLAMA	B. FİYAT
315.313.102	2'Lİ İNGİLİZ PRİZİ	23,00.-TL
315.313.103	3'LÜ İNGİLİZ PRİZİ	26,50.-TL
315.313.104	4'LÜ İNGİLİZ PRİZİ	34,50.-TL

10A

2P + \perp BİLGİSAYAR TİP BLOK PRİZLER

200 - 250V ~

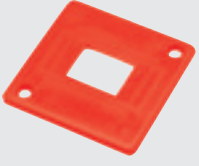

KOD	AÇIKLAMA	B. FİYAT
320.310.002	2'Lİ BİLGİSAYAR PRİZİ	19,50.-TL
320.310.003	3'LÜ BİLGİSAYAR PRİZİ	22,00.-TL
320.310.004	4'LÜ BİLGİSAYAR PRİZİ	25,00.-TL

DÖŞEME ALTI / KANAL ÜSTÜ TELEFON - DATA KAPAKLARI50x50mm TEKLİ
1,80.-TL

708.100.010

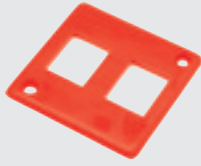
50x50mm ÇİFTLİ
1,80.-TL

708.100.020

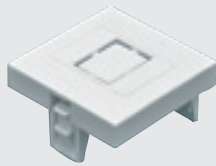
45x45mm
2,00.-TL

709.100.103

22,5x45mm
1,70.-TL

709.100.104

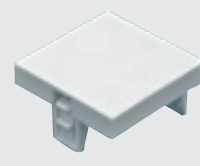
BOŞLUK KAPAKLARI45x45mm
2,00.-TL

709.200.103

22,5x45mm
1,70.-TL

709.200.104

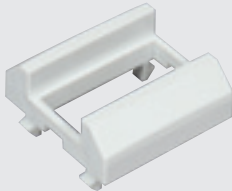
KANAL ÜSTÜ KEYSTONE KAPAKLARI45x45mm
YÜKSELTME KAPAĞI
2,80.-TL

710.100.108

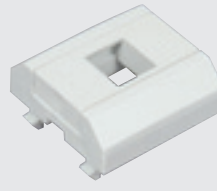
45x45mm
KEYSTONE FACEPLATE-TEKLİ
4,50.-TL

710.100.109

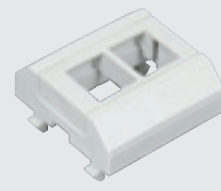
45x45mm
KEYSTONE FACEPLATE-ÇİFTLİ
5,00.-TL

710.100.110

KANAL ÜSTÜ TELEFON - DATA KAPAKLARI22,5x45mm
KAPAKSIZ-TEKLİ
4,00.-TL

710.100.111

45x45mm
KAPAKSIZ-TEKLİ
4,50.-TL

710.100.106

45x45mm
KAPAKSIZ-ÇİFTLİ
5,00.-TL

710.100.107

KANAL ÜSTÜ TELEFON - DATA KAPAKLARI45x45mm
YAYLI KAPAKLI
1,10.-USD

710.100.103

22,5x45mm
YAYLI KAPAKLI
1,00.-USD

710.100.104

45x45mm
YAYLI KAPAKLI-ÇİFTLİ
1,65.-USD

710.100.105

TELEFON - DATA FİŞLERİCAT5 DATA FİŞİ
0,10.-USD

710.100.350

CAT6 DATA FİŞİ
0,50.-USD

710.100.360

TELEFON FİŞİ
0,06.-USD710.100.332-2 PIN
710.100.334-4 PIN
710.100.336-6 PIN **TELEFON - DATA KONNEKTÖRLERİ**CAT5e DATA
2,00.-USD

715.100.050

CAT6 DATA
2,40.-USD

715.100.060

CAT6A DATA
6,20.-USD

715.100.061

CAT3 TELEFON
1,65.-USD

715.100.030

DIŞI/DIŞI TELEFON - DATA KONNEKTÖRLERİCAT5e DATA
3,20.-USD

715.200.050

CAT6 DATA
3,30.-USD

715.200.060

CAT6A DATA
7,00.-USD

715.200.061

CAT3 TELEFON
2,80.-USD

715.200.030

HDMI KONNEKTÖRLERİ

HDMI Konnektör Tip A
Dişi-Dişi 90°
22.5x45mm Faceplate
42,00.-TL



715.400.001

HDMI Konnektör Tip A
Dişi-Dişi 180°
22.5x45mm Faceplate
42,00.-TL



715.400.002

HDMI Konnektör Tip A
Dişi-Dişi Üstten Giriş-Çıkışı
22.5x45mm Faceplate
35,00.-TL



715.400.003

HDMI Konnektör
Tip A Dişi-Dişi Keystone
27,00.-TL



715.400.004

HDMI Konnektör Tip A
Dişi-Dişi Kablolu Keystone
41,00.-TL



715.400.005



USB KONNEKTÖRLERİ

USB Konnektör Standart A
USB AF/AF
90° 22.5x45mm Faceplate
39,00.-TL

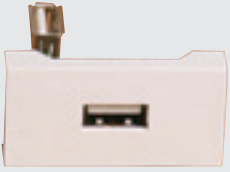

715.200.004

USB Konnektör Standart A
USB AF/AF 180°
22.5x45mm Faceplate
39,00.-TL



715.200.005

USB Konnektör Standart A
Klemensli 22.5x45mm Faceplate
35,00.-TL



715.200.006

USB Konnektör
Standart B
Dişi-Dişi Keystone
25,00.-TL



715.200.001

USB Konnektör
Standart A
Dişi-Dişi Keystone
25,00.-TL



715.200.002

USB Konnektör
Standart A
Dişi-Dişi Kablolu Keystone
41,00.-TL

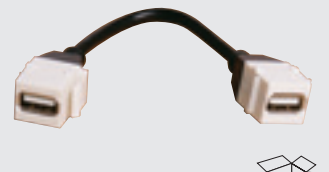

715.200.003



USB ŞARJ

USB Şarj Cihazı
22.5x45mm Tip A - 2A
40,00.-TL

715.200.110 - Beyaz
715.200.111 - Siyah

USB Şarj Cihazı
22.5x45mm Tip A - 1A
35,00.-TL

715.200.100 - Beyaz
715.200.101 - Siyah

USB Şarj Cihazı
45x45mm Tip A/C - 2.1A
47,00.-TL

715.100.100 - Beyaz
715.100.101 - Siyah

USB Şarj Cihazı
45x45mm Tip A/A - 2.1A
45,00.-TL

715.100.110 - Beyaz
715.100.111 - Siyah

VGA KONNEKTÖRLERİ

VGA Konnektör
6 + 2 Girişli 22.5x45mm
Faceplate
33,00.-TL



715.300.001

VGA Konnektör 14 + 2 Girişli
Hızlı Montaj 22.5x45mm
Faceplate
42,00.-TL



715.300.002

VGA Konnektör
Soket Girişli 22.5x45mm
Faceplate
28,00.-TL



715.300.004



RCA & STEREO KONNEKTÖRLERİ

RCA Konnektör
Klemensli 22.5x45mm
Faceplate
35,00.-TL



715.500.002

RCA Konnektör
Klemensli 22.5x45mm
Faceplate
35,00.-TL



715.500.001

Stereo Konnektör
Klemensli 22.5x45mm
Faceplate
35,00.-TL



715.600.001



BİLGİSAYAR SOKETLERİIEC C13 10A
TIRNAKLI GÖVDE PRİZ
5,00.-TL

720.130.150

IEC C13 10A
VİDALI GÖVDE PRİZ
5,00.-TL

720.130.160

IEC C14 10A
TIRNAKLI GÖVDE FİŞ
5,00.-TL

720.140.320

IEC C14 10A
VİDALI GÖVDE FİŞ
5,00.-TL

720.140.340

IEC C19 16A
TIRNAKLI GÖVDE PRİZ
19,00.-TL

720.190.150

IEC C19 16A
VİDALI GÖVDE PRİZ
19,00.-TL

720.190.160

IEC C20 16A
TIRNAKLI GÖVDE FİŞ
19,00.-TL

720.200.320

IEC C20 16A
VİDALI GÖVDE FİŞ
19,00.-TL

720.240.340

IEC C13 10A
SEYYAR PRİZ
6,00.-TL

720.130.200

IEC C19 16A
SEYYAR PRİZ
48,00.-TL

720.190.200

IEC C14 10A
SEYYAR FİŞ
6,00.-TL

720.140.300

IEC C20 16A
SEYYAR FİŞ
48,00.-TL

720.200.300

**45x45mm BİLGİSAYAR SOKETLERİ**IEC C14 10A
45x45mm GÖVDEDE FİŞ
8,50.-TL

720.140.321

IEC C20 16A
45x45mm GÖVDEDE FİŞ
24,00.-TL

720.200.321

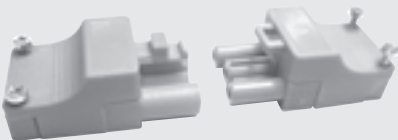
**2,5mm² SOKET KLEMENSLER**BEYAZ
7,50.-TL/TAKIM

720.400.200

SİYAH
7,50.-TL/TAKIM

720.400.201

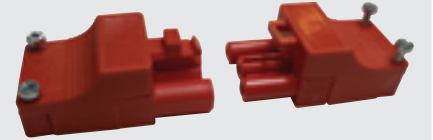
KIRMIZI
7,50.-TL/TAKIM

720.400.202



16A 4h 3 KUTUP**CEE NORM****2P +** **IP44****110 - 130V ~**PANO PRİZİ
13,00.-TL

444.316.150

DUVAR PRİZİ DİK KASALI
17,00.-TL

444.316.151

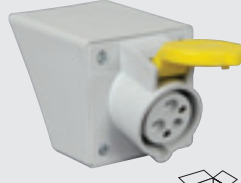
DUVAR PRİZİ
EĞİK KASALI
19,00.-TL

444.316.152

SEYYAR PRİZ
15,50.-TL

444.316.200

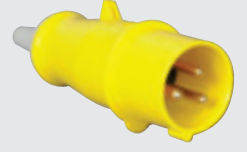
FİŞ
12,50.-TL

444.316.300

**16A 6h 3 KUTUP****CEE NORM****2P +** **IP44****200 - 250V ~**PANO PRİZİ
12,00.-TL

446.316.150

DUVAR PRİZİ DİK KASALI
16,00.-TL

446.316.151

DUVAR PRİZİ EĞİK KASALI
18,00.-TL

446.316.152

DUVAR PRİZİ EĞİK KASALI
MONOFAZE PRİZLİ
24,00.-TL

446.316.153

SEYYAR PRİZ
14,00.-TL

446.316.200

FİŞ
11,00.-TL

446.316.300

**32A 6h 3 KUTUP****CEE NORM****2P +** **200 - 250V ~**IP44 PANO PRİZİ
17,00.-TL

446.332.150

IP44 DUVAR PRİZİ DİK KASALI
23,00.-TL

446.332.151

IP44 DUVAR PRİZİ EĞİK
27,00.-TL

446.332.400

IP44 SEYYAR PRİZ
19,50.-TL

446.332.200

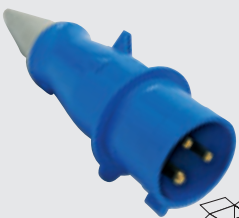
IP44 FİŞ
16,00.-TL

446.332.300

IP67 KİLİTLİ KAPAKLI PANO PRİZİ
21,00.-TL

676.332.150

KİLİTLİ KAPAKLI
DUVAR PRİZİ DİK KASALI
29,00.-TL

676.332.151

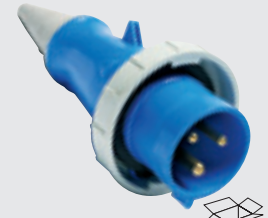
KİLİTLİ FİŞ
19,00.-TL

676.332.300



16A 6h

4 KUTUP

CEE NORM

3P + ⊥

380 - 415V ~

IP44 PANO PRİZİ
14,60.-TL



446.416.150



IP44 PANO PRİZİ
15,50.-TL



446.416.160



IP44 DUVAR PRİZİ DİK KASALI
18,90.-TL



446.416.151



IP44 DUVAR PRİZİ
EĞİK KASALI
20,00.-TL



446.416.152



IP44 DUVAR PRİZİ
EĞİK KASALI MONOFAZE PRİZLİ
25,30.-TL

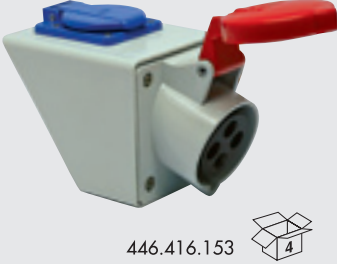

446.416.153



IP44 SEYYAR PRİZ
15,90.-TL



446.416.200



IP44 FİŞ
12,00.-TL



446.416.300



IP67 KİLİTLİ KAPAKLI PANO PRİZİ
19,00.-TL



676.416.160



KİLİTLİ KAPAKLI
DUVAR PRİZİ DİK KASALI
25,30.-TL



676.416.161



KİLİTLİ KAPAKLI SEYYAR PRİZ
21,00.-TL

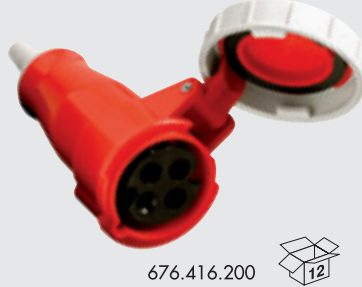

676.416.200



KİLİTLİ FİŞ
14,00.-TL



676.416.300



32A 6h

4 KUTUP

CEE NORM

3P + ⊥

380 - 415V ~

IP44 PANO PRİZİ
18,80.-TL



446.432.150



IP44 DUVAR PRİZİ DİK KASALI
26,50.-TL



446.432.151



IP44 DUVAR PRİZİ EĞİK
28,00.-TL



446.432.400



IP44 SEYYAR PRİZ
23,30.-TL



446.432.200



IP44 FİŞ
17,00.-TL



446.432.300



IP44 MAKİNE FİŞİ
19,90.-TL



446.432.330



IP44 MAKİNE FİŞİ
DÜZ KASALI
28,90.-TL



446.432.331



IP44 MAKİNE FİŞİ
EĞİK KASALI
27,80.-TL



446.432.332



IP44 MAKİNE FİŞİ EĞİK KASALI
MONOFAZE PRİZLİ
31,80.-TL



446.432.333



32A 6h**4 KUTUP****CEE NORM****3P +** **380 - 415V ~**IP67 KİLİTLİ KAPAKLI PANO PRİZİ
21,50.-TL

676.432.150

KİLİTLİ KAPAKLI DUVAR PRİZİ
DİK KASALI
29,00.-TL

676.432.151

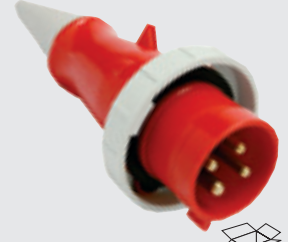
KİLİTLİ FİŞ
20,60.-TL

676.432.300

**63A 6h****4 KUTUP****CEE NORM****3P + + PLT****380 - 415V ~**IP44 PANO PRİZİ
65,50.-TL

446.463.150

IP44 SEYYAR PRİZ
86,00.-TL

446.463.200

IP44 FİŞ
61,00.-TL

446.463.300

IP67 KİLİTLİ KAPAKLI PANO PRİZİ
76,00.-TL

676.463.150

IP67 KİLİTLİ SEYYAR PRİZ
91,00.-TL

676.463.200

IP67 KİLİTLİ FİŞ
71,00.-TL

676.463.300

**16A 6h****5 KUTUP****CEE NORM****3P + N +** **380 - 415V ~**PANO PRİZİ
17,50.-TL

446.516.150

DUVAR PRİZİ DİK KASALI
20,50.-TL

446.516.151

DUVAR PRİZİ EĞİK KASALI
21,00.-TL

446.516.152

DUVAR PRİZİ
EĞİK KASALI MONOFAZE PRİZLİ
29,00.-TL

446.516.153

IP44 DUVAR PRİZİ EĞİK
23,00.-TL

446.516.400

IP44 SEYYAR PRİZ
19,00.-TL

446.516.200

IP44 FİŞ
14,50.-TL

446.516.300

IP44 EĞİK FİŞ
17,50.-TL

446.516.320



16A 6h 5 KUTUP

CEE NORM

3P + N +

380 - 415V ~

IP44 MAKİNE FİŞİ
17,00.-TL



446.516.330



IP44 MAKİNE FİŞİ DÜZ KASALI
21,00.-TL



446.516.331



IP44 MAKİNE FİŞİ EĞİK KASALI
22,50.-TL



446.516.332



IP44 MAKİNE FİŞİ EĞİK KASALI
MONOFAZE PRİZLİ
31,00.-TL



446.516.333



IP67 KİLİTLİ KAPAKLI PANO PRİZİ
21,40.-TL



676.516.150



KİLİTLİ KAPAKLI
DUVAR PRİZİ DİK KASALI
22,90.-TL



676.516.151



KİLİTLİ KAPAKLI
DUVAR PRİZİ EĞİK KASALI
25,50.-TL



676.516.152



KİLİTLİ KAPAKLI DUVAR PRİZİ EĞİK KASALI
MONOFAZE PRİZLİ
35,50.-TL



676.516.153



KİLİTLİ FİŞ
16,50.-TL



676.516.300



32A 6h 5 KUTUP

CEE NORM

3P + N +

380 - 415V ~

IP44 PANO PRİZİ
21,60.-TL



446.532.150



IP44 DUVAR PRİZİ DİK KASALI
29,00.-TL



446.532.151



IP44 SEYYAR PRİZ
23,50.-TL



446.532.200



IP44 FİŞ
18,90.-TL



446.532.300



32A 6h**5 KUTUP****CEE NORM****3P + N + \perp** **380 - 415V ~**IP44 MAKİNE FİŞİ
20,60.-TL

446.532.330

IP44 MAKİNE FİŞİ DÜZ KASALI
23,60.-TL

446.532.331

IP44 MAKİNE FİŞİ EĞİK KASALI
25,00.-TL

446.532.332

IP44 MAKİNE FİŞİ
EĞİK KASALI MONOFAZE PRİZLİ
33,00.-TL

446.532.333

IP67 KİLİTLİ KAPAKLI PANO PRİZİ
25,80.-TL

676.532.150

KİLİTLİ KAPAKLI DUVAR PRİZİ DİK KASALI
31,50.-TL

676.532.151

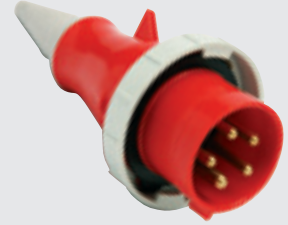
KİLİTLİ FİŞ
21,00.-TL

676.532.300

**63A 6h****5 KUTUP****CEE NORM****3P + N + \perp + PLT****380 - 415V ~**IP44 PANO PRİZİ
74,50.-TL

446.563.150

IP44 SEYYAR PRİZ
101,00.-TL

446.563.200

IP44 FİŞ
76,00.-TL

446.563.300

IP67 KİLİTLİ KAPAKLI PANO PRİZİ
86,00.-TL

676.563.150

IP67 KİLİTLİ SEYYAR PRİZ
109,00.-TL

676.563.200

IP67 KİLİTLİ FİŞ
84,00.-TL

676.563.300



SEYYAR 3'LÜ ÇOKLAYICI PRİZ (REKOR GİRİŞLİ)

50/60 Hz.

IP44



KOD	KUTUP	I (A)	VOLT	RENK	H		B. FİYAT
1344.316.333.1	2P + T	16	200-250	◆	6	2	133,00.-TL
1344.332.333.1	2P + T	32	200-250	◆	6	4	203,00.-TL
1344.416.333.1	3P + T	16	380-415	◆	6	2	148,00.-TL
1344.432.333.1	3P + T	32	380-415	◆	6	2	212,00.-TL
1344.516.333.1	3P + N + T	16	380-415	◆	6	2	174,00.-TL
1344.532.333.1	3P + N + T	32	380-415	◆	6	2	232,00.-TL

SEYYAR 3'LÜ ÇOKLAYICI PRİZ (FİŞ GİRİŞLİ)

50/60 Hz.

IP44



KOD	KUTUP	I (A)	VOLT	RENK	H		B. FİYAT
1344.316.333.0	2P + T	16	200-250	◆	6	2	143,00.-TL
1344.332.333.0	2P + T	32	200-250	◆	6	4	225,00.-TL
1344.416.333.0	3P + T	16	380-415	◆	6	2	157,00.-TL
1344.432.333.0	3P + T	32	380-415	◆	6	2	252,00.-TL
1344.516.333.0	3P + N + T	16	380-415	◆	6	2	196,00.-TL
1344.532.333.0	3P + N + T	32	380-415	◆	6	2	265,00.-TL

SEYYAR 3'LÜ ÇOKLAYICI PRİZ (REKOR GİRİŞLİ)

50/60 Hz.

IP67





KOD	KUTUP	I (A)	VOLT	RENK	H		B. FİYAT
1367.316.333.1	2P + T	16	200-250	◆	6	2	151,00.-TL
1367.332.333.1	2P + T	32	200-250	◆	6	4	232,00.-TL
1367.416.333.1	3P + T	16	380-415	◆	6	2	167,00.-TL
1367.432.333.1	3P + T	32	380-415	◆	6	2	240,00.-TL
1367.516.333.1	3P + N + T	16	380-415	◆	6	4	196,00.-TL
1367.532.333.1	3P + N + T	32	380-415	◆	6	4	259,00.-TL

SEYYAR 3'LÜ ÇOKLAYICI PRİZ (FİŞ GİRİŞLİ)

50/60 Hz.

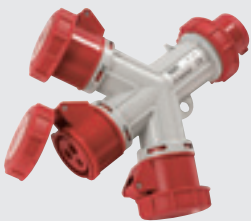
IP67



KOD	KUTUP	I (A)	VOLT	RENK	H		B. FİYAT
1367.316.333.0	2P + T	16	200-250	◆	6	2	168,00.-TL
1367.332.333.0	2P + T	32	200-250	◆	6	4	256,00.-TL
1367.416.333.0	3P + T	16	380-415	◆	6	2	186,00.-TL
1367.432.333.0	3P + T	32	380-415	◆	6	2	267,00.-TL
1367.516.333.0	3P + N + T	16	380-415	◆	6	4	219,00.-TL
1367.532.333.0	3P + N + T	32	380-415	◆	6	4	294,00.-TL

DİK PANO PRİZİ**50/60 Hz.****IP44****75x75**

KOD	KUTUP	I (A)	VOLT	RENK	H		B. FİYAT
446.316.180	2P + T	16	200-250	◆	6	10	13,50.-TL
446.332.180	2P + T	32	200-250	◆	6	5	19,00.-TL
446.416.180	3P + T	16	380-415	◆	6	10	16,00.-TL
446.432.180	3P + T	32	380-415	◆	6	5	22,50.-TL
446.516.180	3P + N + T	16	380-415	◆	6	8	19,50.-TL
446.532.180	3P + N + T	32	380-415	◆	6	5	24,20.-TL

EĞİK PANO PRİZİ**50/60 Hz.****IP44**

KOD	KUTUP	I (A)	VOLT	RENK	H		B. FİYAT
446.316.190	2P + T	16	200-250	◆	6	10	13,50.-TL
446.332.190	2P + T	32	200-250	◆	6	5	19,00.-TL
446.416.190	3P + T	16	380-415	◆	6	10	16,00.-TL
446.432.190	3P + T	32	380-415	◆	6	5	22,50.-TL
446.516.190	3P + N + T	16	380-415	◆	6	8	19,50.-TL
446.532.190	3P + N + T	32	380-415	◆	6	5	24,20.-TL

SEYYAR PRİZ**50/60 Hz.****IP44**

KOD	KUTUP	I (A)	VOLT	RENK	H		B. FİYAT
446.316.240	2P + T	16	200-250	◆	6	10	14,50.-TL
446.332.240	2P + T	32	200-250	◆	6	4	21,50.-TL
446.416.240	3P + T	16	380-415	◆	6	10	17,50.-TL
446.432.240	3P + T	32	380-415	◆	6	4	25,00.-TL
446.516.240	3P + N + T	16	380-415	◆	6	5	19,50.-TL
446.532.240	3P + N + T	32	380-415	◆	6	3	25,00.-TL

SEYYAR FİŞ**50/60 Hz.****IP44**

KOD	KUTUP	I (A)	VOLT	RENK	H		B. FİYAT
446.316.340	2P + T	16	200-250	◆	6	10	10,50.-TL
446.332.340	2P + T	32	200-250	◆	6	5	16,50.-TL
446.416.340	3P + T	16	380-415	◆	6	10	12,50.-TL
446.432.340	3P + T	32	380-415	◆	6	5	18,50.-TL
446.516.340	3P + N + T	16	380-415	◆	6	8	15,00.-TL
446.532.340	3P + N + T	32	380-415	◆	6	4	21,00.-TL

EĞİK DUVAR PRİZİ**50/60 Hz.****IP44**

KOD	KUTUP	I (A)	VOLT	RENK	H		B. FİYAT
446.316.410	2P + T	16	200-250	◆	6	3	25,00.-TL
446.332.410	2P + T	32	200-250	◆	6	2	31,00.-TL
446.416.410	3P + T	16	380-415	◆	6	3	25,50.-TL
446.432.410	3P + T	32	380-415	◆	6	2	34,00.-TL
446.516.410	3P + N + T	16	380-415	◆	6	3	29,50.-TL
446.532.410	3P + N + T	32	380-415	◆	6	2	37,00.-TL

DİK PANO PRİZİ 50/60 Hz. IP67 75x75

KOD	KUTUP	I (A)	VOLT	RENK	H		B. FİYAT
676.316.180	2P + T	16	200-250	◆	6	8	22,50.-TL
676.332.180	2P + T	32	200-250	◆	6	5	28,00.-TL
676.416.180	3P + T	16	380-415	◆	6	8	26,00.-TL
676.432.180	3P + T	32	380-415	◆	6	5	31,20.-TL
676.516.180	3P + N + T	16	380-415	◆	6	8	27,50.-TL
676.532.180	3P + N + T	32	380-415	◆	6	5	33,00.-TL

EĞİK PANO PRİZİ 50/60 Hz. IP67

KOD	KUTUP	I (A)	VOLT	RENK	H		B. FİYAT
676.316.190	2P + T	16	200-250	◆	6	10	22,50.-TL
676.332.190	2P + T	32	200-250	◆	6	5	28,00.-TL
676.416.190	3P + T	16	380-415	◆	6	8	26,00.-TL
676.432.190	3P + T	32	380-415	◆	6	5	31,20.-TL
676.516.190	3P + N + T	16	380-415	◆	6	8	27,50.-TL
676.532.190	3P + N + T	32	380-415	◆	6	5	33,00.-TL

SEYYAR PRİZ 50/60 Hz. IP67

KOD	KUTUP	I (A)	VOLT	RENK	H		B. FİYAT
676.316.240	2P + T	16	200-250	◆	6	10	22,50.-TL
676.332.240	2P + T	32	200-250	◆	6	4	31,00.-TL
676.416.240	3P + T	16	380-415	◆	6	8	27,20.-TL
676.432.240	3P + T	32	380-415	◆	6	4	33,00.-TL
676.516.240	3P + N + T	16	380-415	◆	6	4	29,00.-TL
676.532.240	3P + N + T	32	380-415	◆	6	3	34,00.-TL

SEYYAR FİŞ 50/60 Hz. IP67

KOD	KUTUP	I (A)	VOLT	RENK	H		B. FİYAT
676.316.340	2P + T	16	200-250	◆	6	10	17,50.-TL
676.332.340	2P + T	32	200-250	◆	6	4	24,50.-TL
676.416.340	3P + T	16	380-415	◆	6	8	19,00.-TL
676.432.340	3P + T	32	380-415	◆	6	4	27,00.-TL
676.516.340	3P + N + T	16	380-415	◆	6	6	22,50.-TL
676.532.340	3P + N + T	32	380-415	◆	6	3	28,50.-TL

EĞİK DUVAR PRİZİ 50/60 Hz. IP67

KOD	KUTUP	I (A)	VOLT	RENK	H		B. FİYAT
676.316.410	2P + T	16	200-250	◆	6	3	36,00.-TL
676.332.410	2P + T	32	200-250	◆	6	2	39,50.-TL
676.416.410	3P + T	16	380-415	◆	6	3	36,50.-TL
676.432.410	3P + T	32	380-415	◆	6	2	43,50.-TL
676.516.410	3P + N + T	16	380-415	◆	6	3	39,50.-TL
676.532.410	3P + N + T	32	380-415	◆	6	2	44,50.-TL

İÇTEN KİLİTLİ ŞALTERLİ PANO PRİZİ YATAY TİP

50/60 Hz.

IP44



KOD	KUTUP	I (A)	VOLT	RENK	H		B. FİYAT
1444.316.15	2P + T	16	200-250	◆	6	1	109,00.-TL
1444.332.15	2P + T	32	200-250	◆	6	1	137,00.-TL
1444.416.15	3P + T	16	380-415	◆	6	1	124,00.-TL
1444.432.15	3P + T	32	380-415	◆	6	1	155,00.-TL
1444.516.15	3P + N + T	16	380-415	◆	6	1	138,00.-TL
1444.532.15	3P + N + T	32	380-415	◆	6	1	157,00.-TL

İÇTEN KİLİTLİ ŞALTERLİ PANO PRİZİ YATAY TİP

50/60 Hz.

IP67



KOD	KUTUP	I (A)	VOLT	RENK	H		B. FİYAT
1467.316.15	2P + T	16	200-250	◆	6	1	137,00.-TL
1467.332.15	2P + T	32	200-250	◆	6	1	167,00.-TL
1467.416.15	3P + T	16	380-415	◆	6	1	152,00.-TL
1467.432.15	3P + T	32	380-415	◆	6	1	181,00.-TL
1467.516.15	3P + N + T	16	380-415	◆	6	1	167,00.-TL
1467.532.15	3P + N + T	32	380-415	◆	6	1	196,00.-TL

İÇTEN KİLİTLİ ŞALTERLİ DUVAR PRİZİ YATAY TİP

50/60 Hz.

IP44



KOD	KUTUP	I (A)	VOLT	RENK	H		B. FİYAT
1444.316.10	2P + T	16	200-250	◆	6	1	133,00.-TL
1444.332.10	2P + T	32	200-250	◆	6	1	155,00.-TL
1444.416.10	3P + T	16	380-415	◆	6	1	138,00.-TL
1444.432.10	3P + T	32	380-415	◆	6	1	157,00.-TL
1444.516.10	3P + N + T	16	380-415	◆	6	1	155,00.-TL
1444.532.10	3P + N + T	32	380-415	◆	6	1	167,00.-TL

İÇTEN KİLİTLİ ŞALTERLİ DUVAR PRİZİ YATAY TİP

50/60 Hz.

IP67



KOD	KUTUP	I (A)	VOLT	RENK	H		B. FİYAT
1467.316.10	2P + T	16	200-250	◆	6	1	155,00.-TL
1467.332.10	2P + T	32	200-250	◆	6	1	187,00.-TL
1467.416.10	3P + T	16	380-415	◆	6	1	163,00.-TL
1467.432.10	3P + T	32	380-415	◆	6	1	194,00.-TL
1467.516.10	3P + N + T	16	380-415	◆	6	1	187,00.-TL
1467.532.10	3P + N + T	32	380-415	◆	6	1	205,00.-TL

İÇTEN KİLİTLİ ŞALTERLİ PANO PRİZİ DİKEY TİP

50/60 Hz.

IP44



KOD	KUTUP	I (A)	VOLT	RENK	H		B. FİYAT
1944.316.15	2P + T	16	200-250	◆	6	1	109,00.-TL
1944.332.15	2P + T	32	200-250	◆	6	1	137,00.-TL
1944.416.15	3P + T	16	380-415	◆	6	1	124,00.-TL
1944.432.15	3P + T	32	380-415	◆	6	1	155,00.-TL
1944.516.15	3P + N + T	16	380-415	◆	6	1	138,00.-TL
1944.532.15	3P + N + T	32	380-415	◆	6	1	157,00.-TL

İÇTEN KİLİTLİ ŞALTERLİ PANO PRİZİ DİKEY TİP

50/60 Hz.

IP67



KOD	KUTUP	I (A)	VOLT	RENK	H		B. FİYAT
1967.316.15	2P + T	16	200-250	◆	6	1	137,00.-TL
1967.332.15	2P + T	32	200-250	◆	6	1	167,00.-TL
1967.416.15	3P + T	16	380-415	◆	6	1	152,00.-TL
1967.432.15	3P + T	32	380-415	◆	6	1	181,00.-TL
1967.516.15	3P + N + T	16	380-415	◆	6	1	167,00.-TL
1967.532.15	3P + N + T	32	380-415	◆	6	1	196,00.-TL

İÇTEN KİLİTLİ ŞALTERLİ DUVAR PRİZİ DİKEY TİP

50/60 Hz.

IP44



KOD	KUTUP	I (A)	VOLT	RENK	H		B. FİYAT
1944.316.10	2P + T	16	200-250	◆	6	1	133,00.-TL
1944.332.10	2P + T	32	200-250	◆	6	1	155,00.-TL
1944.416.10	3P + T	16	380-415	◆	6	1	138,00.-TL
1944.432.10	3P + T	32	380-415	◆	6	1	157,00.-TL
1944.516.10	3P + N + T	16	380-415	◆	6	1	155,00.-TL
1944.532.10	3P + N + T	32	380-415	◆	6	1	167,00.-TL

İÇTEN KİLİTLİ ŞALTERLİ DUVAR PRİZİ DİKEY TİP

50/60 Hz.

IP67



KOD	KUTUP	I (A)	VOLT	RENK	H		B. FİYAT
1967.316.10	2P + T	16	200-250	◆	6	1	155,00.-TL
1967.332.10	2P + T	32	200-250	◆	6	1	187,00.-TL
1967.416.10	3P + T	16	380-415	◆	6	1	163,00.-TL
1967.432.10	3P + T	32	380-415	◆	6	1	194,00.-TL
1967.516.10	3P + N + T	16	380-415	◆	6	1	187,00.-TL
1967.532.10	3P + N + T	32	380-415	◆	6	1	205,00.-TL

İÇTEN KİLİTLİ ŞALTERLİ-SİGORTALI PANO PRİZİ

50/60 Hz.

IP44



KOD	KUTUP	I (A)	VOLT	RENK	H		B. FİYAT
1644.316.15	2P + T	16	200-250	◆	6	1	167,00.-TL
1644.332.15	2P + T	32	200-250	◆	6	1	210,00.-TL
1644.416.15	3P + T	16	380-415	◆	6	1	181,00.-TL
1644.432.15	3P + T	32	380-415	◆	6	1	236,00.-TL
1644.516.15	3P + N + T	16	380-415	◆	6	1	196,00.-TL
1644.532.15	3P + N + T	32	380-415	◆	6	1	247,00.-TL

İÇTEN KİLİTLİ ŞALTERLİ-SİGORTALI PANO PRİZİ

50/60 Hz.

IP67



KOD	KUTUP	I (A)	VOLT	RENK	H		B. FİYAT
1667.316.15	2P + T	16	200-250	◆	6	1	175,00.-TL
1667.332.15	2P + T	32	200-250	◆	6	1	218,00.-TL
1667.416.15	3P + T	16	380-415	◆	6	1	189,00.-TL
1667.432.15	3P + T	32	380-415	◆	6	1	240,00.-TL
1667.516.15	3P + N + T	16	380-415	◆	6	1	203,00.-TL
1667.532.15	3P + N + T	32	380-415	◆	6	1	253,00.-TL

İÇTEN KİLİTLİ ŞALTERLİ-SİGORTALI DUVAR PRİZİ

50/60 Hz.

IP44



KOD	KUTUP	I (A)	VOLT	RENK	H		B. FİYAT
1644.316.10	2P + T	16	200-250	◆	6	1	189,00.-TL
1644.332.10	2P + T	32	200-250	◆	6	1	230,00.-TL
1644.416.10	3P + T	16	380-415	◆	6	1	204,00.-TL
1644.432.10	3P + T	32	380-415	◆	6	1	253,00.-TL
1644.516.10	3P + N + T	16	380-415	◆	6	1	218,00.-TL
1644.532.10	3P + N + T	32	380-415	◆	6	1	268,00.-TL

İÇTEN KİLİTLİ ŞALTERLİ-SİGORTALI DUVAR PRİZİ

50/60 Hz.

IP67



KOD	KUTUP	I (A)	VOLT	RENK	H		B. FİYAT
1667.316.10	2P + T	16	200-250	◆	6	1	196,00.-TL
1667.332.10	2P + T	32	200-250	◆	6	1	236,00.-TL
1667.416.10	3P + T	16	380-415	◆	6	1	210,00.-TL
1667.432.10	3P + T	32	380-415	◆	6	1	260,00.-TL
1667.516.10	3P + N + T	16	380-415	◆	6	1	225,00.-TL
1667.532.10	3P + N + T	32	380-415	◆	6	1	276,00.-TL

U42 ALÜMİNYUM GRUP PRİZLER

STANDART GRUP PRİZLER

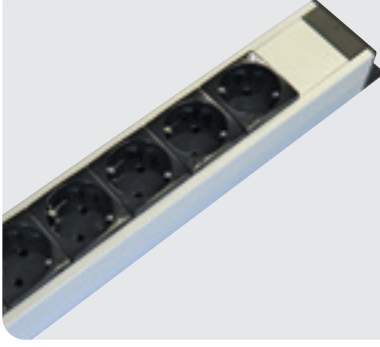

KOD	AÇIKLAMA	BİRİM FİYAT	KOD	AÇIKLAMA	BİRİM FİYAT
1420.1000.6000.0	6 Şebeke	76,00.-TL	1420.0200.0600.0	6 UPS	83,00.-TL
1420.1000.7000.0	7 Şebeke	88,00.-TL	1420.0200.0700.0	7 UPS	93,00.-TL
1420.1000.8000.0	8 Şebeke	94,00.-TL	1420.0200.0800.0	8 UPS	102,00.-TL
1420.1000.9000.0	9 Şebeke	102,00.-TL	1420.0200.0900.0	9 UPS	110,00.-TL
1420.1000.10000.0	10 Şebeke	113,00.-TL	1420.0200.01000.0	10 UPS	119,00.-TL

SİGORTALI GRUP PRİZLER



KOD	AÇIKLAMA	BİRİM FİYAT	KOD	AÇIKLAMA	BİRİM FİYAT
1421.1000.6000.0	6 Şebeke + Sigorta	97,00.-TL	1421.0200.0600.0	6 UPS + Sigorta	104,00.-TL
1421.1000.7000.0	7 Şebeke + Sigorta	107,00.-TL	1421.0200.0700.0	7 UPS + Sigorta	112,00.-TL
1421.1000.8000.0	8 Şebeke + Sigorta	115,00.-TL	1421.0200.0800.0	8 UPS + Sigorta	120,00.-TL
1421.1000.9000.0	9 Şebeke + Sigorta	122,00.-TL	1421.0200.0900.0	9 UPS + Sigorta	122,00.-TL
1421.1000.10000.0	10 Şebeke + Sigorta	131,00.-TL	1421.0200.01000.0	10 UPS + Sigorta	138,00.-TL

ANAHTARLI GRUP PRİZLER



KOD	AÇIKLAMA	BİRİM FİYAT	KOD	AÇIKLAMA	BİRİM FİYAT
1423.1000.6000.0	6 Şebeke + Anahtar	90,00.-TL	1423.0200.0600.0	6 UPS + Anahtar	96,00.-TL
1423.1000.7000.0	7 Şebeke + Anahtar	100,00.-TL	1423.0200.0700.0	7 UPS + Anahtar	106,00.-TL
1423.1000.8000.0	8 Şebeke + Anahtar	106,00.-TL	1423.0200.0800.0	8 UPS + Anahtar	112,00.-TL
1423.1000.9000.0	9 Şebeke + Anahtar	114,00.-TL	1423.0200.0900.0	9 UPS + Anahtar	122,00.-TL
1423.1000.10000.0	10 Şebeke + Anahtar	124,00.-TL	1423.0200.01000.0	10 UPS + Anahtar	130,00.-TL

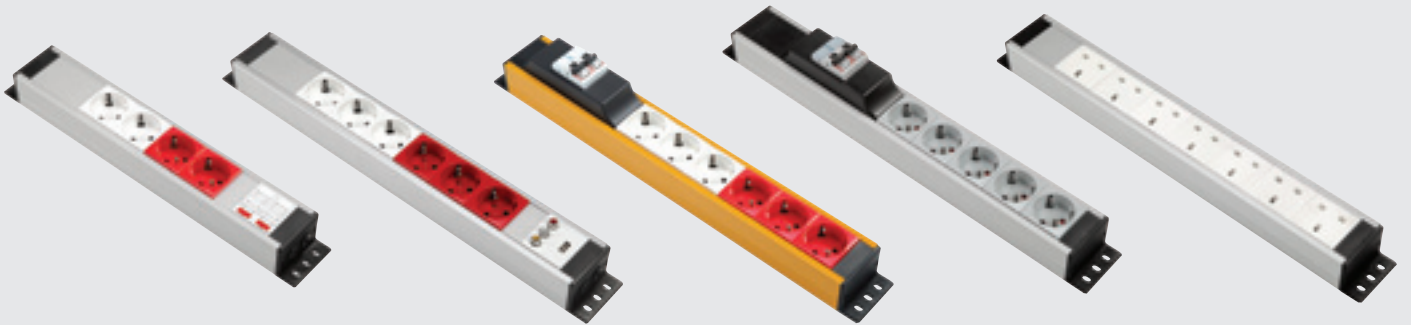

KOD	ÖZEL GRUPLAR	BİRİM FİYAT
1420.1278.2222.0	2 Şebeke+2 Ups+2 22.5mm Cat6+2 22.5mm RJ11 Cat3	122,00.-TL
1420.1278.3211.0	3 Şebeke+2 Ups+1 22.5mm Cat6+1 22.5mm RJ11 Cat3	104,00.-TL
1420.1278.2312.0	2 Şebeke+3 Ups+2 22.5mm Cat6+1 22.5mm RJ11 Cat3	122,00.-TL
1420.1278.3311.0	3 Şebeke+3 Ups+1 22.5mm Cat6+1 22.5mm RJ11 Cat3	112,00.-TL

* Listede olmayan Özel Priz Grupları için fiyat isteyiniz.

W42 ALÜMİNYUM GRUP PRİZLER



STANDART GRUP PRİZLER

KOD	AÇIKLAMA	BİRİM FİYAT	KOD	AÇIKLAMA	BİRİM FİYAT
1430.1000.9000.0	9 Şebeke	121,00.-TL	1430.0200.9000.0	9 UPS	130,00.-TL
1430.1000.12000.0	12 Şebeke	134,00.-TL	1430.0200.12000.0	12 UPS	148,00.-TL
1430.1000.15000.0	15 Şebeke	165,00.-TL	1430.0200.15000.0	15 UPS	181,00.-TL



SIGORTALI GRUP PRİZLER

KOD	AÇIKLAMA	BİRİM FİYAT	KOD	AÇIKLAMA	BİRİM FİYAT
1431.1000.9000.0	9 Şebeke + Sigorta	156,00.-TL	1431.0200.9000.0	9 UPS + Sigorta	166,00.-TL
1431.1000.12000.0	12 Şebeke + Sigorta	170,00.-TL	1431.0200.12000.0	12 UPS + Sigorta	178,00.-TL
1431.1000.15000.0	15 Şebeke + Sigorta	200,00.-TL	1431.0200.15000.0	15 UPS + Sigorta	215,00.-TL

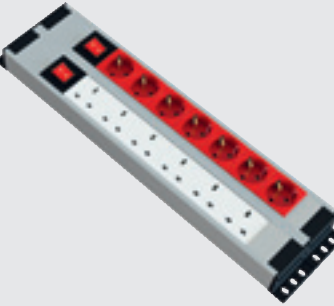

ANAHTARLI GRUP PRİZLER

KOD	AÇIKLAMA	BİRİM FİYAT	KOD	AÇIKLAMA	BİRİM FİYAT
1433.1000.9000.0	9 Şebeke + Anahtar	150,00.-TL	1433.0200.9000.0	9 UPS + Anahtar	156,00.-TL
1433.1000.12000.0	12 Şebeke + Anahtar	162,00.-TL	1433.0200.12000.0	12 UPS + Anahtar	174,00.-TL
1433.1000.15000.0	15 Şebeke + Anahtar	194,00.-TL	1433.0200.15000.0	15 UPS + Anahtar	210,00.-TL

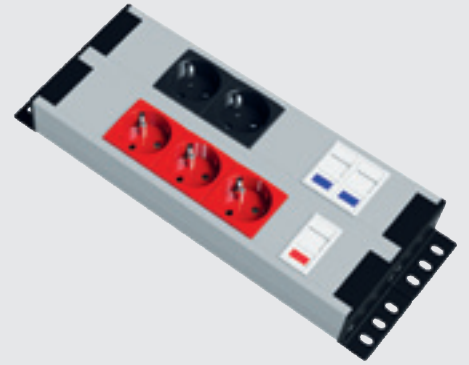
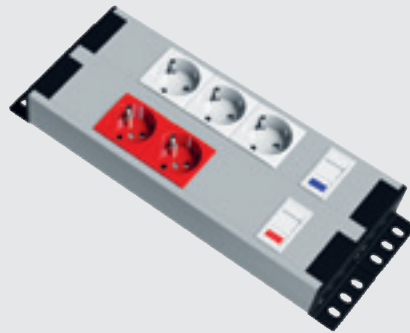
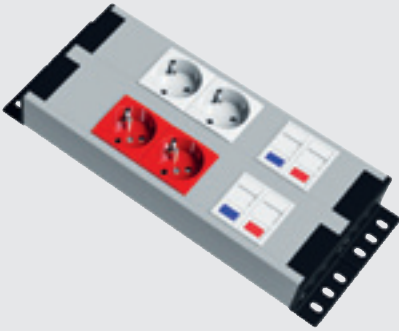

KOD	ÖZEL GRUPLAR	BİRİM FİYAT
1430.1278.6622.0	2 Şebeke+2 Ups+2 22.5mm Cat6+2 22.5mm RJ11 Cat3	140,00.-TL
1430.1278.8440.0	3 Şebeke+2 Ups+1 22.5mm Cat6+1 22.5mm RJ11 Cat3	122,00.-TL
1430.1278.2813.0	2 Şebeke+3 Ups+2 22.5mm Cat6+1 22.5mm RJ11 Cat3	137,00.-TL

* Listede olmayan Özel Priz Grupları için fiyat isteyiniz.

U62 ALÜMİNYUM GRUP PRİZLER



KOD	BOŞ KANAL	BİRİM FİYAT
1620.0000.0010.0	5x45mm Boy - 2x22.5mm Alüminyum kapaklı+Yan Kapak+Kulak	44,00.-TL
1620.0000.0012.0	6x45mm Boy - 2x22.5mm Alüminyum kapaklı+Yan Kapak+Kulak	49,00.-TL
1620.0000.0014.0	7x45mm Boy - 2x22.5mm Alüminyum kapaklı+Yan Kapak+Kulak	54,00.-TL
1620.0000.0016.0	8x45mm Boy - 2x22.5mm Alüminyum kapaklı+Yan Kapak+Kulak	59,00.-TL
1620.0000.0018.0	9x45mm Boy - 2x22.5mm Alüminyum kapaklı+Yan Kapak+Kulak	64,00.-TL
1620.0000.0020.0	10x45mm Boy - 2x22.5mm Alüminyum kapaklı+Yan Kapak+Kulak	69,00.-TL



KOD	ÖZEL GRUPLAR	BİRİM FİYAT
1620.1278.2222.0	2 Şebeke+2 Ups+2 22.5mm Cat6+2 22.5mm RJ11 Cat3	136,00.-TL
1620.1278.3211.0	3 Şebeke+2 Ups+1 22.5mm Cat6+1 22.5mm RJ11 Cat3	114,00.-TL
1620.1278.2312.0	2 Şebeke+3 Ups+2 22.5mm Cat6+1 22.5mm RJ11 Cat3	132,00.-TL
1620.1278.3311.0	3 Şebeke+3 Ups+1 22.5mm Cat6+1 22.5mm RJ11 Cat3	124,00.-TL



KOD	AYAKLI ÖZEL GRUPLAR	KARE AYAK B. FİYAT XXXX=1278	YUVARLAK AYAK B. FİYAT XXXX=1279
1650.XXXX.2222.0	2 Şebeke+2 Ups+2 22.5mm Cat6+2 22.5mm RJ11 Cat3-Tek Sütunlu	216,00.-TL	168,00.-TL
1650.XXXX.3211.0	3 Şebeke+2 Ups+1 22.5mm Cat6+1 22.5mm RJ11 Cat3-Tek Sütunlu	196,00.-TL	146,00.-TL
1650.XXXX.2312.0	2 Şebeke+3 Ups+2 22.5mm Cat6+1 22.5mm RJ11 Cat3-Tek Sütunlu	212,00.-TL	163,00.-TL
1652.XXXX.3311.0	3 Şebeke+3 Ups+2 Sigorta+1 22.5mm Cat6+1 22.5mm RJ11 Cat3-Tek Sütunlu	240,00.-TL	190,00.-TL
1630.XXXX.4440.0	2 (4 Şebeke+4 Ups+4 22.5mm Cat6) - Çift Sütunlu	412,00.-TL	362,00.-TL
1630.XXXX.6633.0	2 (6 Şebeke+6 Ups+3 22.5mm Cat6+3 22.5mm RJ11 Cat3)-Çift Sütunlu	526,00.-TL	476,00.-TL
1630.XXXX.8430.0	8 Şebeke+4 Ups+3 22.5mm Cat6 - Çift Sütunlu	294,00.-TL	242,00.-TL
1632.XXXX.5533.0	5 Şebeke+5 Ups+2 Sigorta+3 22.5mm Cat6+3 22.5mm RJ11 Cat3-Çift Sütunlu	360,00.-TL	308,00.-TL

* Listede olmayan Özel Priz Grupları için fiyat isteyiniz.

1U ALÜMİNYUM GRUP PRİZLER

STANDART GRUP PRİZLER



KOD	AÇIKLAMA	BİRİM FİYAT
1400.1000.6000.0	6 Şebeke	56,00.-TL
1400.1000.7000.0	7 Şebeke	63,00.-TL
1400.1000.8000.0	8 Şebeke	68,00.-TL
1400.1000.9000.0	9 Şebeke	72,00.-TL
1400.1000.10000.0	10 Şebeke	78,00.-TL

KOD	AÇIKLAMA	BİRİM FİYAT
1400.0200.6000.0	6 UPS	61,00.-TL
1400.0200.7000.0	7 UPS	67,00.-TL
1400.0200.8000.0	8 UPS	72,00.-TL
1400.0200.9000.0	9 UPS	76,00.-TL
1400.0200.10000.0	10 UPS	83,00.-TL

SİGORTALI GRUP PRİZLER

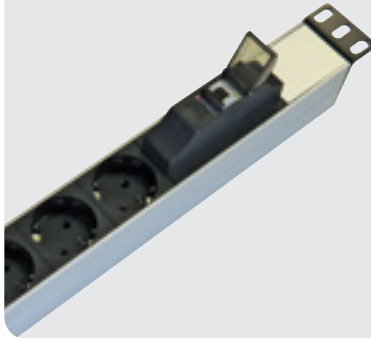

KOD	AÇIKLAMA	BİRİM FİYAT
1401.1000.6000.0	6 Şebeke + Sigorta	76,00.-TL
1401.1000.7000.0	7 Şebeke + Sigorta	83,00.-TL
1401.1000.8000.0	8 Şebeke + Sigorta	88,00.-TL
1401.1000.9000.0	9 Şebeke + Sigorta	92,00.-TL
1401.1000.10000.0	10 Şebeke + Sigorta	98,00.-TL

KOD	AÇIKLAMA	BİRİM FİYAT
1401.0200.6000.0	6 UPS + Sigorta	80,00.-TL
1401.0200.7000.0	7 UPS + Sigorta	88,00.-TL
1401.0200.8000.0	8 UPS + Sigorta	92,00.-TL
1401.0200.9000.0	9 UPS + Sigorta	96,00.-TL
1401.0200.10000.0	10 UPS + Sigorta	102,00.-TL

ANAHTARLI GRUP PRİZLER



KOD	AÇIKLAMA	BİRİM FİYAT
1403.1000.6000.0	6 Şebeke + Anahtar	70,00.-TL
1403.1000.7000.0	7 Şebeke + Anahtar	76,00.-TL
1403.1000.8000.0	8 Şebeke + Anahtar	78,00.-TL
1403.1000.9000.0	9 Şebeke + Anahtar	82,00.-TL
1403.1000.10000.0	10 Şebeke + Anahtar	90,00.-TL

KOD	AÇIKLAMA	BİRİM FİYAT
1403.0200.6000.0	6 UPS + Anahtar	72,00.-TL
1403.0200.7000.0	7 UPS + Anahtar	78,00.-TL
1403.0200.8000.0	8 UPS + Anahtar	84,00.-TL
1403.0200.9000.0	9 UPS + Anahtar	88,00.-TL
1403.0200.10000.0	10 UPS + Anahtar	96,00.-TL

W1U ALÜMİNYUM GRUP PRİZLER

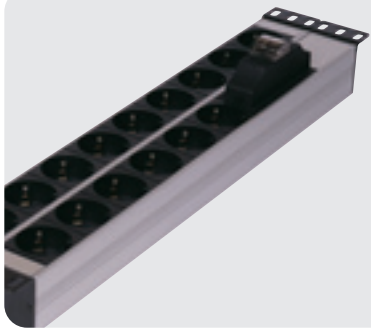

KOD	AÇIKLAMA	BİRİM FİYAT
1410.1000.12000.0	12 Şebeke	96,00.-TL
1411.1000.9000.0	9 Şebeke + Sigorta	105,00.-TL
1411.1000.12000.0	12 Şebeke + Sigorta	127,00.-TL
1413.1000.12000.0	12 Şebeke + 2 Anahtar	130,00.-TL

KOD	AÇIKLAMA	BİRİM FİYAT
1410.0200.12000.0	12 UPS	102,00.-TL
1411.0200.9000.0	9 UPS + Sigorta	110,00.-TL
1411.0200.12000.0	12 UPS + Sigorta	134,00.-TL
1413.0200.12000.0	12 UPS + 2 Anahtar	136,00.-TL

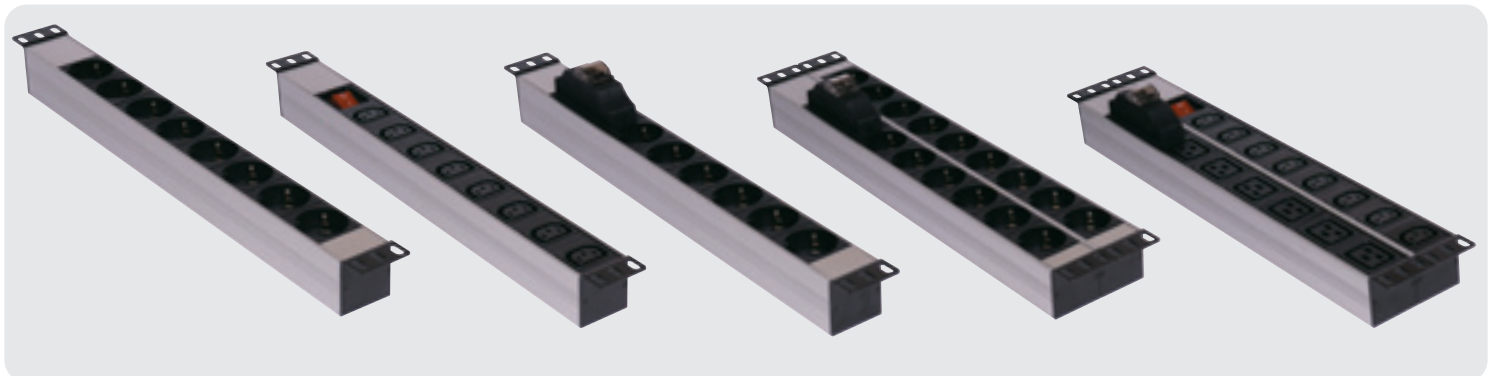

* Listede olmayan Özel Priz Grupları için fiyat isteyiniz.

G70 MASA ÜZERİ ALÜMİNYUM GRUP PRİZLER



KOD	AÇIKLAMA	a		B. FİYAT
1700.2780.3110	3UPS + 1 Cat6 + 1 Cat3	279mm	1	110,00.-TL



1700.1278.2210	2 Şebeke + 2UPS + 1 Cat6 + 1 Cat3	346mm	1	118,00.-TL
----------------	-----------------------------------	-------	---	------------



1700.2611.3111	3 UPS + 1 Üniversal + 1 Cat6 + 1 Cat3	346mm	1	144,00.-TL
----------------	---------------------------------------	-------	---	------------



1700.2789.3111	3 UPS + 1 Cat6 + 1 Cat3 + 1 USB Şarj	301mm	1	168,00.-TL
----------------	--------------------------------------	-------	---	------------



KOD	AÇIKLAMA	a		B. FİYAT
740.050.030	Montaj Ayağı	30mm	1	40,00.-TL
740.050.070	Montaj Ayağı	70mm	1	60,00.-TL

* Listede olmayan Özel Priz Grupları için fiyat isteyiniz.

O44 ALÜMİNYUM GÖVDELİ DIKEY MASA İÇİ GRUBU



KOD	AÇIKLAMA	a		B. FİYAT
1440.1900.2200.0	2 Şebeke + 2 USB Şarj	210mm	1	170,00.-TL
1440.2900.2200.0	2 UPS + 2 USB Şarj	210mm	1	172,00.-TL

- Standart masa deliklerine uygundur
- Kullanılmadıkça yer kaplamayan grup priz
- Masaya zarar vermeyen kurulum
- Özel kilit mekanizması
- Masa kesim ölçüsü Ø 60mm

KOD	AÇIKLAMA	a		B. FİYAT
1444.1900.3340.0	2 Şebeke+Gerilim Koruma+2 USB Şarj	276mm	1	196,00.-TL
1447.1800.4200.1	2 UPS+Gerilim Koruma+2 USB Şarj	276mm	1	198,00.-TL

* Listede olmayan Özel Priz Grupları için fiyat isteyiniz.

L47 ALÜMİNYUM GÖVDELİ YATAY MASA İÇİ GRUBU

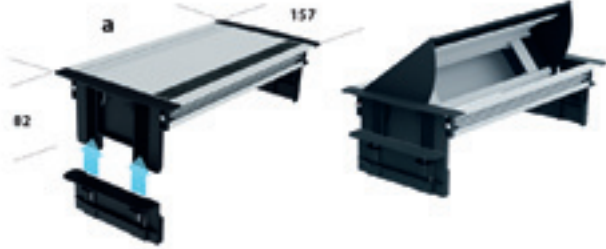

KOD	BOŞ YATAY MASA GRUPLARI	a mm	Kesim Ölçüsü mm		B. FİYAT
1447.0000.0010.0	5x45 (2x22.5 Alüm. Kapaklı)	327	295x134	1	104,00.-TL
1447.0000.0012.0	6x45 (2x22.5 Alüm. Kapaklı)	372	340x134	1	114,00.-TL
1447.0000.0014.0	7x45 (2x22.5 Alüm. Kapaklı)	417	385x134	1	122,00.-TL
1447.0000.0016.0	8x45 (2x22.5 Alüm. Kapaklı)	462	430x134	1	130,00.-TL

KOD	ÖZEL YATAY MASA GRUPLARI	a	Kesim Ölçüsü mm		B. FİYAT
-----	--------------------------	---	-----------------	---	----------

1447.1800.4200.1	4 Şebeke+Kablo+2 22.5mm Cat6	394mm	362x134	1	178,00.-TL
------------------	------------------------------	-------	---------	---	------------

1447.1278.2211.0	2 Şebeke+2 Ups+1 22.5mm Cat6 +1 22.5mm RJ11 Cat3	416mm	384x134	1	170,00.-TL
------------------	---	-------	---------	---	------------

1447.1280.3440.2	2 Şebeke+4 Ups+Soket Girişli +4 22.5mm Cat6	552mm	520x134	1	238,00.-TL
------------------	--	-------	---------	---	------------

1447.1280.3340.0	3 Şebeke+3 Ups+4 22.5mm Cat6	552mm	520x134	1	224,00.-TL
------------------	------------------------------	-------	---------	---	------------



220 V PRİZLİ PANO ARMATÜRLERİ - 1U 8W

1405

1406

KOD	AÇIKLAMA		MIKNATISSIZ B. FİYAT	MIKNATISLI B. FİYAT
1405.0220.1020.1	2 Şebeke 32cm Boy 13cm Led Kablolu	1	120,00.-TL	145,00.-TL
1405.1030.1020.1	2 Şebeke 32cm Boy 13cm Led Kablolu + Swich Kablolu	1	124,00.-TL	150,00.-TL
1405.0004.1020.1	2 Şebeke 32cm Boy 13cm Led Kablolu + Sensörlü	1	165,00.-TL	210,00.-TL

LİNEER LED ARMATÜRLERİ - U20

1812

1813







KOD	AÇIKLAMA		MIKNATISSIZ B. FİYAT	MIKNATISLI B. FİYAT
1812.0024.0020.1	24 V 1m Kablolu 20cm 4.3W 360 Lümen	1	22,00.-TL	24,00.-TL
1812.0024.0030.1	24 V 1m Kablolu 30cm 4.3W 360 Lümen	1	32,00.-TL	36,00.-TL
1812.0024.0050.1	24 V 1m Kablolu 50cm 7.2W 600 Lümen	1	54,00.-TL	60,00.-TL
1812.0024.0100.1	24 V 1m Kablolu 100cm 14.1W 1200 Lümen	1	88,00.-TL	98,00.-TL
1812.0220.0035.1	220 V 1m Kablolu 35cm 5 W 400 Lümen	1	34,00.-TL	38,00.-TL
1812.1030.0040.1	220 V 1m Kablolu 41cm 6 W 480 Lümen	1	36,00.-TL	40,00.-TL
1812.0004.0050.1	220 V 1m Kablolu 52cm 10 W 800 Lümen	1	42,00.-TL	46,00.-TL

MASA ÜZERİ LEDLİ ÖZEL GRUPLAR - G70 220V

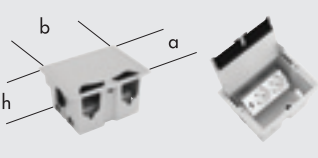
KOD	AÇIKLAMA		B. FİYAT
1705.1000.1020.53	53cm Boy - 2 Şebeke Priz+30cm 16W Led Anahtarlı	1	154,00.-TL
1705.1000.1040.45	45cm Boy - 4 Şebeke Priz+13cm 8W Led Anahtarlı	1	130,00.-TL
1705.1000.1060.71	71,5cm Boy - 6 Şebeke Priz+2x30cm 16W Led Anahtarlı	1	198,00.-TL
1705.1000.1821.41	1cm Boy - 2 Şebeke Priz+Anahtar+15cm 8W Led Anahtarlı	1	130,00.-TL
1705.1000.1842.67	67cm Boy - 4 Şebeke Priz+2 Anahtar+30cm 16W Led Anahtarlı	1	200,00.-TL
1705.4000.1040.62	62cm Boy - 4 Şebeke Priz+30cm 16W Led Sensörlü	1	220,00.-TL
740.050.001	Masa Bağlantı Ayağı	1	40,00.-TL

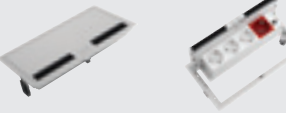
* Listede olmayan Özel Priz Grupları için fiyat isteyiniz.

PLASTİK GÖVDELİ MASA GRUPLARI

	MODÜL	KOD	KASALI MASA GRUBU	a	b	h	B. FİYAT
				mm			
	2.5x45mm	800.025.02X	Priz Kasası (Fırçalı-Gri, Siyah, Beyaz)	126	175	104	80,00.-TL
		800.025.02X	Priz Kasası (Metalik Kaplama)				100,00.-TL
	2.5x45mm	800.025.12X	Priz Kasası (Fırçalı-Gri, Siyah, Beyaz)	80	170	103	70,00.-TL
		800.025.12X	Priz Kasası (Metalik Kaplama)				90,00.-TL
	4.5x45mm	800.045.01X	Priz Kasası (Tpe-Gri, Siyah)	127	253	63	54,00.-TL
		800.045.02X	Priz Kasası (Fırçalı-Gri, Siyah)				75,00.-TL
		800.045.02X	Priz Kasası (Fırçalı-Metalik Kaplama)				92,00.-TL
	4.5x45mm	800.045.11X	Priz Kasası (Tpe-Gri)	127	253	120	90,00.-TL
		800.045.12X	Priz Kasası (Fırçalı-Gri, Siyah)				108,00.-TL
		800.045.12X	Priz Kasası (Fırçalı-Metalik Kaplama)				130,00.-TL
	5x45mm	800.050.02X	Priz Kasası (Fırçalı-Gri, Siyah, Beyaz)	126	175	104	85,00.-TL
		800.050.02X	Priz Kasası (Fırçalı-Metalik Kaplama)				104,00.-TL
	9x45mm	800.090.01X	Priz Kasası (Tpe-Gri, Siyah)	127	253	120	92,00.-TL
		800.090.02X	Priz Kasası (Fırçalı-Gri, Siyah)				112,00.-TL
		800.090.02X	Priz Kasası (Fırçalı-Metalik Kaplama)				135,00.-TL

X = 1-Gri 2-Metalik Kaplama 3-Siyah 6-Beyaz

ALÜMİNYUM GÖVDELİ MASA GRUPLARI

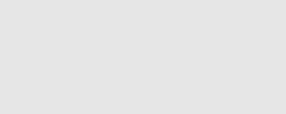
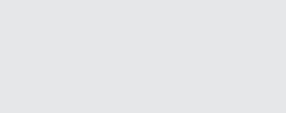
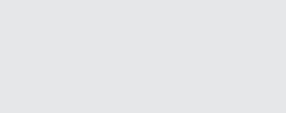
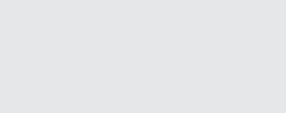
	MODÜL	KOD			b mm	B. FİYAT
		Eloksal Kaplı Priz Kasası	Siyah Kaplı Priz Kasası	Beyaz Kaplı Priz Kasası		
	2x45mm	810.020.011	810.020.013	810.020.016	132	110,00.-TL
		Eloksal Kaplı Priz Kasası	Siyah Kaplı Priz Kasası	Beyaz Kaplı Priz Kasası		
	3x45mm	810.030.011	810.030.013	810.030.016	171	130,00.-TL
		Eloksal Kaplı Priz Kasası	Siyah Kaplı Priz Kasası	Beyaz Kaplı Priz Kasası		
	4x45mm	810.040.011	810.040.013	810.040.016	238	155,00.-TL
		Eloksal Kaplı Priz Kasası	Siyah Kaplı Priz Kasası	Beyaz Kaplı Priz Kasası		
	5x45mm	810.050.011	810.050.013	810.050.016	279	178,00.-TL
		Eloksal Kaplı Priz Kasası	Siyah Kaplı Priz Kasası	Beyaz Kaplı Priz Kasası		
	6x45mm	810.060.011	810.060.013	810.060.016	342	200,00.-TL
		Eloksal Kaplı Priz Kasası	Siyah Kaplı Priz Kasası	Beyaz Kaplı Priz Kasası		
	7x45mm	810.070.011	810.070.013	810.070.016	387	215,00.-TL
		Eloksal Kaplı Priz Kasası	Siyah Kaplı Priz Kasası	Beyaz Kaplı Priz Kasası		
	8x45mm	810.080.011	810.080.013	810.080.016	449	230,00.-TL
		Eloksal Kaplı Priz Kasası	Siyah Kaplı Priz Kasası	Beyaz Kaplı Priz Kasası		
	9x45mm	810.090.011	810.090.013	810.090.016	474	245,00.-TL
		Eloksal Kaplı Priz Kasası	Siyah Kaplı Priz Kasası	Beyaz Kaplı Priz Kasası		
	10x45mm	810.100.011	810.100.013	810.100.016	534	257,00.-TL
		Eloksal Kaplı Priz Kasası	Siyah Kaplı Priz Kasası	Beyaz Kaplı Priz Kasası		

* Verilen ölçüler masa kesim ölçüsüdür.

113x210mm DAHİLİ PRİZ KUTULARI

113x210x70mm
13,50.-TL



210.000.000

4 ŞEBEKE + 4 UPS PRİZLİ
77,00.-TL



210.044.000

8 UPS PRİZLİ
82,00.-TL



210.008.000



8 ŞEBEKE PRİZLİ
73,00.-TL



210.080.000

6 UPS+2(1x25A) Sigortalı
90,00.-TL



210.206.000

6 ŞEBEKE+2(1x25A) Sigortalı
83,00.-TL



210.260.000



210x280mm DAHİLİ PRİZ KUTULARI

210x280x70mm
25,00.-TL



280.000.000

6 ŞEBEKE+6 UPS PRİZLİ
107,00.-TL



280.066.000

6 UPS+3 T-103+(1x25A) Sigortalı
97,00.-TL



280.106.300



6 ŞEBEKE+6 T-104+(1x25A) Sigortalı
113,00.-TL



280.160.060

9 UPS+2(1x25A) Sigortalı
117,00.-TL



280.209.000

9 ŞEBEKE+2(1x25A) Sigortalı
106,00.-TL



280.290.000



260 x 350mm PRİZ MONTAJLI SİGORTALI KOMBİNASYON KUTULARI (12 SİGORTA KAPASİTELİ)
(HALOJEN FREE)

IP44

KOD	AÇIKLAMA		B. FİYAT
351.0012.0000.000	260 x 350 x 120 mm IP44 Boş Kombinasyon Kutusu	1	52,00.-TL
351.4160.1160.224	2 Ad. IP44 4x16A CEE +2 Ad. IP44 1x16A Ön + 4 Ad. 1x16A Yan	1	122,00.-TL
351.0000.4160.042	4 Ad. IP44 4x16A CEE Ön + 2 Ad. 1x16A Yan	1	123,00.-TL
351.0000.3163.044	4 Ad. IP44 3x16A Ön + 4 Ad. 1x16A Yan	1	121,00.-TL
351.3323.3163.224	2 Ad. IP44 3x32A Ön +2 Ad. IP44 3x16A Ön + 4 Ad. 1x16A Yan	1	124,00.-TL
351.0000.3323.044	4 Ad. IP44 3x32A Ön + 4 Ad. 1x16A Yan	1	127,00.-TL
351.4320.4250.222	2 Ad. IP44 4x32A CEE Ön +2 Ad. IP44 4x25A Ön + 2 Ad. 1x16A Yan	1	122,50.-TL
351.0000.4250.044	4 Ad. IP44 4x25A Ön + 4 Ad. 1x16A Yan	1	118,00.-TL
351.0000.4320.046	4 Ad. IP44 4x32A CEE Ön + 6 Ad. 1x16A Yan	1	165,00.-TL
351.0000.4321.044	4 Ad. IP67 4x32A CEE Ön + 4 Ad. 1x16A Yan	1	163,00.-TL
351.4631.4321.222	2 Ad. IP67 4x63A CEE Ön +2 Ad. IP67 4x32A CEE Ön + 2 Ad. 1x16A Yan	1	259,50.-TL
351.0000.4630.028	2 Ad. IP44 4x63A CEE Ön +4 Ad. 1x16A Ön + 4 Ad. 1x16A Yan	1	233,50.-TL
351.5320.5160.222	2 Ad. IP44 5x32A CEE Ön +2 Ad. IP44 5x16A CEE Ön + 2 Ad. 1x16A Yan	1	143,00.-TL
351.0000.5321.046	4 Ad. IP67 5x32A CEE Ön + 6 Ad. 1x16A Yan	1	193,00.-TL
351.5631.5321.222	2 Ad. IP67 5x63A CEE Ön +2 Ad. IP67 5x32A CEE Ön + 2 Ad. 1x16A Yan	1	288,00.-TL

IP67

KOD	AÇIKLAMA		B. FİYAT
451.0012.0000.000	260 x 350 x 120 mm IP67 Boş Kombinasyon Kutusu	1	57,00.-TL
451.4160.1160.224	2 Ad. IP44 4x16A CEE +2 Ad. IP44 1x16A Ön + 4 Ad. 1x16A Yan	1	127,50.-TL
451.0000.4160.042	4 Ad. IP44 4x16A CEE Ön + 2 Ad. 1x16A Yan	1	128,00.-TL
451.0000.3163.044	4 Ad. IP44 3x16A Ön + 4 Ad. 1x16A Yan	1	126,00.-TL
451.3323.3163.224	2 Ad. IP44 3x32A Ön +2 Ad. IP44 3x16A Ön + 4 Ad. 1x16A Yan	1	129,00.-TL
451.0000.3323.044	4 Ad. IP44 3x32A Ön + 4 Ad. 1x16A Yan	1	132,00.-TL
451.4320.4250.222	2 Ad. IP44 4x32A CEE Ön +2 Ad. IP44 4x25A Ön + 2 Ad. 1x16A Yan	1	127,50.-TL
451.0000.4250.044	4 Ad. IP44 4x25A Ön + 4 Ad. 1x16A Yan	1	123,00.-TL
451.0000.4320.046	4 Ad. IP44 4x32A CEE Ön + 6 Ad. 1x16A Yan	1	170,00.-TL
451.0000.4321.044	4 Ad. IP67 4x32A CEE Ön + 4 Ad. 1x16A Yan	1	168,00.-TL
451.4631.4321.222	2 Ad. IP67 4x63A CEE Ön +2 Ad. IP67 4x32A CEE Ön + 2 Ad. 1x16A Yan	1	264,50.-TL
451.0000.4630.028	2 Ad. IP44 4x63A CEE Ön +4 Ad. 1x16A Ön + 4 Ad. 1x16A Yan	1	238,50.-TL
451.5320.5160.222	2 Ad. IP44 5x32A CEE Ön +2 Ad. IP44 5x16A CEE Ön + 2 Ad. 1x16A Yan	1	148,00.-TL
451.0000.5321.046	4 Ad. IP67 5x32A CEE Ön + 6 Ad. 1x16A Yan	1	198,00.-TL
451.5631.5321.222	2 Ad. IP67 5x63A CEE Ön +2 Ad. IP67 5x32A CEE Ön + 2 Ad. 1x16A Yan	1	293,00.-TL



451.0012.0000.000



451.4160.1160.224



451.0000.4630.028



451.3323.3163.224



451.4631.4321.222

210 x 280mm PRİZ MONTAJLI SİGORTALI KOMBİNASYON KUTULARI (8 SİGORTA KAPASİTELİ) (HALOJEN FREE)

IP44

KOD	AÇIKLAMA		B. FİYAT
352.0008.0000.000	210x280x100 mm IP44 Boş Kombinasyon Kutusu	1	40,00.-TL
352.0000.4160.011	1 Ad. IP44 4x16A CEE Ön + 1 Ad. 1x16A Ön	1	61,00.-TL
352.0000.4160.012	1 Ad. IP44 4x16A CEE Ön + 2 Ad. 1x16A Ön	1	67,00.-TL
352.0000.4160.022	2 Ad. IP44 4x16A CEE Ön + 2 Ad. 1x16A Yan	1	82,00.-TL
352.0000.4250.021	2 Ad. IP44 4x25A Ön + 1 Ad. 1x16A Yan	1	67,00.-TL
352.0000.4250.022	2 Ad. IP44 4x25A Ön + 2 Ad. 1x16A Yan	1	73,00.-TL
352.0000.4320.022	2 Ad. IP44 4x32A CEE Ön + 2 Ad. 1x16A Yan	1	90,00.-TL
352.0000.4321.024	2 Ad. IP67 4x32A CEE Ön + 4 Ad. 1x16A Yan	1	108,00.-TL
352.0000.5160.022	2 Ad. IP44 5x16A CEE Ön + 2 Ad. 1x16A Yan	1	87,50.-TL
352.0000.5320.012	1 Ad. IP44 5x32A CEE Ön + 2 Ad. 1x16A Ön	1	74,00.-TL
352.0000.5320.022	2 Ad. IP44 5x32A CEE Ön + 2 Ad. 1x16A Yan	1	96,00.-TL
352.0000.5321.014	1 Ad. IP67 5x32A CEE Ön + 2 Ad. 1x16A Ön + 2 Ad. 1x16A Yan	1	91,00.-TL
352.0000.3163.022	2 Ad. IP44 3x16A Ön + 2 Ad. 1x16A Yan	1	74,50.-TL
352.3323.3163.112	1 Ad. IP44 3x32A Ön + 1 Ad. IP44 3x16A Ön + 2 Ad. 1x16A Yan	1	76,00.-TL
352.0000.3323.022	2 Ad. IP44 3x32A Ön + 2 Ad. 1x16A Yan	1	77,50.-TL

IP67

KOD	AÇIKLAMA		B. FİYAT
452.0008.0000.000	210x280x100 mm IP67 Boş Kombinasyon Kutusu	1	48,00.-TL
452.0000.4160.011	1 Ad. IP44 4x16A CEE Ön + 1 Ad. 1x16A Ön	1	69,00.-TL
452.0000.4160.012	1 Ad. IP44 4x16A CEE Ön + 2 Ad. 1x16A Ön	1	75,00.-TL
452.0000.4160.022	2 Ad. IP44 4x16A CEE Ön + 2 Ad. 1x16A Yan	1	90,00.-TL
452.0000.4250.021	2 Ad. IP44 4x25A Ön + 1 Ad. 1x16A Yan	1	75,00.-TL
452.0000.4250.022	2 Ad. IP44 4x25A Ön + 2 Ad. 1x16A Yan	1	81,00.-TL
452.0000.4320.022	2 Ad. IP44 4x32A CEE Ön + 2 Ad. 1x16A Yan	1	98,00.-TL
452.0000.4321.024	2 Ad. IP67 4x32A CEE Ön + 4 Ad. 1x16A Yan	1	116,00.-TL
452.0000.5160.022	2 Ad. IP44 5x16A CEE Ön + 2 Ad. 1x16A Yan	1	95,50.-TL
452.0000.5320.012	1 Ad. IP44 5x32A CEE Ön + 2 Ad. 1x16A Ön	1	82,00.-TL
452.0000.5320.022	2 Ad. IP44 5x32A CEE Ön + 2 Ad. 1x16A Yan	1	104,00.-TL
452.0000.5321.014	1 Ad. IP67 5x32A CEE Ön + 2 Ad. 1x16A Ön + 2 Ad. 1x16A Yan	1	99,00.-TL
452.0000.3163.022	2 Ad. IP44 3x16A Ön + 2 Ad. 1x16A Yan	1	82,50.-TL
452.3323.3163.112	1 Ad. IP44 3x32A Ön + 1 Ad. IP44 3x16A Ön + 2 Ad. 1x16A Yan	1	84,00.-TL
452.0000.3323.022	2 Ad. IP44 3x32A Ön + 2 Ad. 1x16A Yan	1	85,50.-TL



452.0008.0000.000



452.0000.4160.011



452.0000.4160.012



452.0000.4320.022



452.0000.4321.024

135 x 250mm PRİZ MONTAJLI SİGORTALI KOMBİNASYON KUTULARI (6 SİGORTA KAPASİTELİ) (HALOJEN FREE)

IP44

KOD	AÇIKLAMA		B. FİYAT
363.0006.0000.000	135x250x120 mm IP44 Boş Kombinasyon Kutusu	2	23,00.-TL
363.0000.3163.012	1 Ad. IP44 3x16A Ön + 2 Ad. 1x16A Yan	2	46,50.-TL
363.0000.3323.012	1 Ad. IP44 3x32A Ön + 2 Ad. 1x16A Yan	2	48,00.-TL
363.0000.4250.012	1 Ad. IP44 4x25A Ön + 2 Ad. 1x16A Yan	2	46,00.-TL
363.0000.4160.012	1 Ad. IP44 4x16A CEE Ön + 2 Ad. 1x16A Yan	2	50,00.-TL
363.0000.4320.012	1 Ad. IP44 4x32A CEE Ön + 2 Ad. 1x16A Yan	2	54,50.-TL
363.0000.5160.012	1 Ad. IP44 5x16A CEE Ön + 2 Ad. 1x16A Yan	2	53,00.-TL
363.0000.5320.012	1 Ad. IP44 5x32A CEE Ön + 2 Ad. 1x16A Yan	2	57,00.-TL

IP67

KOD	AÇIKLAMA		B. FİYAT
463.0006.0000.000	135x250x120 mm IP64 Boş Kombinasyon Kutusu	2	25,50.-TL
463.0000.3163.012	1 Ad. IP44 3x16A Ön + 2 Ad. 1x16A Yan	2	49,00.-TL
463.0000.3323.012	1 Ad. IP44 3x32A Ön + 2 Ad. 1x16A Yan	2	50,50.-TL
463.0000.4250.012	1 Ad. IP44 4x25A Ön + 2 Ad. 1x16A Yan	2	48,50.-TL
463.0000.4160.012	1 Ad. IP44 4x16A CEE Ön + 2 Ad. 1x16A Yan	2	52,50.-TL
463.0000.4320.012	1 Ad. IP44 4x32A CEE Ön + 2 Ad. 1x16A Yan	2	57,00.-TL
463.0000.5160.012	1 Ad. IP44 5x16A CEE Ön + 2 Ad. 1x16A Yan	2	55,50.-TL
463.0000.5320.012	1 Ad. IP44 5x32A CEE Ön + 2 Ad. 1x16A Yan	2	60,00.-TL



463.0006.0000.000

463.0000.5160.012

463.0000.5320.012

463.0000.4160.012

463.0000.4250.012

113 x 210mm PRİZ MONTAJLI SİGORTALI KOMBİNASYON KUTULARI (4 SİGORTA KAPASİTELİ) (HALOJEN FREE)

IP44

KOD	AÇIKLAMA		B. FİYAT
353.0004.0000.000	113x210x90 mm IP44 Boş Kombinasyon Kutusu	3	21,00.-TL
353.0000.3163.012	1 Ad. IP44 3x16A Ön + 2 Ad. 1x16A Yan	3	44,50.-TL
353.0000.3323.012	1 Ad. IP44 3x32A Ön + 2 Ad. 1x16A Yan	3	46,00.-TL
353.0000.4250.012	1 Ad. IP44 4x25A Ön + 2 Ad. 1x16A Yan	3	44,00.-TL
353.0000.4160.012	1 Ad. IP44 4x16A CEE Ön + 2 Ad. 1x16A Yan	3	48,00.-TL
353.0000.4320.012	1 Ad. IP44 4x32A CEE Ön + 2 Ad. 1x16A Yan	3	52,50.-TL
353.0000.5160.012	1 Ad. IP44 5x16A CEE Ön + 2 Ad. 1x16A Yan	3	51,00.-TL
353.0000.5320.012	1 Ad. IP44 5x32A CEE Ön + 2 Ad. 1x16A Yan	3	55,00.-TL

IP67

KOD	AÇIKLAMA		B. FİYAT
453.0004.0000.000	113x210x90 mm IP64 Boş Kombinasyon Kutusu	3	24,00.-TL
453.0000.3163.012	1 Ad. IP44 3x16A Ön + 2 Ad. 1x16A Yan	3	47,50.-TL
453.0000.3323.012	1 Ad. IP44 3x32A Ön + 2 Ad. 1x16A Yan	3	49,00.-TL
453.0000.4250.012	1 Ad. IP44 4x25A Ön + 2 Ad. 1x16A Yan	3	47,00.-TL
453.0000.4160.012	1 Ad. IP44 4x16A CEE Ön + 2 Ad. 1x16A Yan	3	51,00.-TL
453.0000.4320.012	1 Ad. IP44 4x32A CEE Ön + 2 Ad. 1x16A Yan	3	55,50.-TL
453.0000.5160.012	1 Ad. IP44 5x16A CEE Ön + 2 Ad. 1x16A Yan	3	54,00.-TL
453.0000.5320.012	1 Ad. IP44 5x32A CEE Ön + 2 Ad. 1x16A Yan	3	58,00.-TL



453.0004.0000.000



453.0000.4163.012



453.0000.4320.012



453.0000.5160.012

113 x 210mm PRİZ MONTAJLI SİGORTALI KOMBİNASYON KUTULARI (4 SİGORTA KAPASİTELİ)
(HALOJEN FREE)

KOD	AÇIKLAMA		B. FİYAT
454.0004.0000.000	113x210x90 mm Boş Kombinasyon Kutusu	3	17,50.-TL
454.0000.3320.012	1 Ad. IP44 3x32A CEE Ön + 2 Ad. 1x16A Yan	3	47,00.-TL
454.0000.4160.012	1 Ad. IP44 4x16A CEE Ön + 2 Ad. 1x16A Yan	3	44,50.-TL
454.0000.3163.012	1 Ad. IP44 3x16A Ön + 2 Ad. 1x16A Yan	3	41,00.-TL
454.0000.3323.012	1 Ad. IP44 3x32A Ön + 2 Ad. 1x16A Yan	3	42,50.-TL



454.0004.0000.000



454.0000.3320.012



454.0000.4160.012



454.0000.4163.012



454.0000.4323.012

PRİZ MONTAJLI SİGORTASIZ KOMBİNASYON KUTULARI
(HALOJEN FREE)

IP44

KOD	AÇIKLAMA		B. FİYAT
355.0000.0000.000	210x280x100 mm IP44 Boş Kombinasyon Kutusu	1	35,00.-TL
355.4320.4160.224	2 Ad. IP44 4x32A CEE Ön + 2Ad. IP44 4x16A CEE Ön + 4 Ad. 1x16A Yan	1	127,00.-TL
355.4320.5160.220	2 Ad. IP44 4x32A CEE Ön + 2Ad. IP44 5x16A CEE Ön	1	107,50.-TL
356.0000.0000.000	113x113x73 mm IP44 Boş Kombinasyon Kutusu	6	8,00.-TL
356.0000.4160.012	1 Ad. IP44 4x16A CEE Ön + 2 Ad. 1x16A Yan	6	35,00.-TL
356.0000.5160.012	1 Ad. IP44 5x16A CEE Ön + 2 Ad. 1x16A Yan	6	38,00.-TL
357.0000.0000.000	210x113x73 mm IP44 Boş Kombinasyon Kutusu	3	12,00.-TL
357.0000.4320.022	2 Ad. IP44 4x32A CEE Ön + 2 Ad. 1x16A Yan	3	62,00.-TL
357.0000.5320.022	2 Ad. IP44 5x32A CEE Ön + 2 Ad. 1x16A Yan	3	68,00.-TL

IP67

KOD	AÇIKLAMA		B. FİYAT
455.0000.0000.000	210x280x100 mm IP65 Boş Kombinasyon Kutusu	1	42,00.-TL
455.4321.4161.224	2 Ad. IP67 4x32A CEE Ön + 2Ad. IP67 4x16A CEE Ön + 4 Ad. 1x16A Yan	1	148,00.-TL
455.4320.5160.220	2 Ad. IP44 4x32A CEE Ön + 2Ad. IP44 5x16A CEE Ön	1	114,50.-TL
456.0000.0000.000	113x113x73 mm IP65 Boş Kombinasyon Kutusu	6	11,00.-TL
456.0000.4160.012	1 Ad. IP44 4x16A CEE Ön + 2 Ad. 1x16A Yan	6	38,00.-TL
456.0000.5160.012	1 Ad. IP44 5x16A CEE Ön + 2 Ad. 1x16A Yan	6	41,00.-TL
457.0000.0000.000	210x113x73 mm IP65 Boş Kombinasyon Kutusu	3	17,00.-TL
457.0000.4320.022	2 Ad. IP44 4x32A CEE Ön + 2 Ad. 1x16A Yan	3	67,00.-TL
457.0000.5320.022	2 Ad. IP44 5x32A CEE Ön + 2 Ad. 1x16A Yan	3	73,60.-TL



455.0000.0000.000



455.4321.4161.224



455.4320.5160.220



456.0000.4160.012



457.0000.5320.022

OPAK KAPAKLI TERMOPLASTİK BUATLAR (HALOJEN FREE)

IP44 KOD	IP65 KOD	DIŞ ÖLÇÜ (mm)		IP44 B. FİYAT	IP65 B. FİYAT
380.041.100	-	85 x 85 x 41	24	4,20.-TL	-
300.073.300	400.073.300	113 x 113 x 73	12	8,00.-TL	12,50.-TL
300.120.310	400.120.310	113 x 113 x 120	6	10,50.-TL	15,00.-TL
300.073.400	400.073.400	113 x 210 x 73	6	12,50.-TL	18,00.-TL
300.120.410	400.120.410	113 x 210 x 120	3	15,50.-TL	21,00.-TL
300.085.420	400.085.420	130 x 245 x 85	2	20,00.-TL	25,50.-TL
300.140.420	400.140.420	130 x 245 x 140	2	22,00.-TL	27,50.-TL
300.100.500	400.100.500	210 x 280 x 100	1	30,00.-TL	36,00.-TL
300.135.600	400.135.600	210 x 280 x 135	1	36,00.-TL	42,00.-TL
300.115.500	400.115.500	260 x 350 x 115	1	48,00.-TL	56,00.-TL
300.155.600	400.155.600	260 x 350 x 155	1	61,00.-TL	69,00.-TL



400.073.300



400.073.400



400.100.500



400.155.600



400.135.600

ŞEFFAF KAPAKLI TERMOPLASTİK BUATLAR (HALOJEN FREE)

IP44 KOD	IP65 KOD	DIŞ ÖLÇÜ (mm)		IP44 B. FİYAT	IP65 B. FİYAT
300.073.305	400.073.305	113 x 113 x 73	12	9,60.-TL	15,00.-TL
300.120.315	400.120.315	113 x 113 x 120	6	12,60.-TL	18,00.-TL
300.073.405	400.073.405	113 x 210 x 73	6	15,00.-TL	21,60.-TL
300.120.415	400.120.415	113 x 210 x 120	3	18,60.-TL	25,20.-TL
300.085.425	400.085.425	130 x 245 x 85	2	24,00.-TL	30,60.-TL
300.140.425	400.140.425	130 x 245 x 140	2	26,40.-TL	33,00.-TL
300.100.505	400.100.505	210 x 280 x 100	1	36,00.-TL	40,00.-TL
300.135.605	400.135.605	210 x 280 x 135	1	43,20.-TL	50,40.-TL
300.115.505	400.115.505	260 x 350 x 115	1	52,00.-TL	60,00.-TL
300.155.605	400.155.605	260 x 350 x 155	1	70,00.-TL	78,00.-TL



400.073.305



400.073.405



400.100.505



400.155.605



400.135.605

ÖZEL ÖRNEKLER

451.012.100 ÖZEL



452.008.100 ÖZEL



454.000.200 ÖZEL



455.000.200 ÖZEL



400.115.505 ÖZEL



322635 ÖZEL

METAL GÖVDELİ KABLOLU MAKARALAR



KOD	SCHUKO 1x16A 4Ad.+3x1.5 TTR	BİRİM FİYAT
100.020.154	20m.	205,00.-TL
100.025.154	25m.	220,00.-TL
100.030.154	30m.	240,00.-TL
100.035.154	35m.	260,00.-TL
100.040.154	40m.	280,00.-TL
100.050.154	50m.	310,00.-TL

KOD	SCHUKO 1x16A 4Ad.+3x2.5 TTR	BİRİM FİYAT
100.020.254	20m.	242,00.-TL
100.025.254	25m.	265,00.-TL
100.030.254	30m.	295,00.-TL
100.035.254	35m.	324,00.-TL
100.040.254	40m.	350,00.-TL

KOD	SCHUKO 1x16A 4Ad.+3x1.5 TTR	BİRİM FİYAT
120.050.154	50 m.	375,00.-TL
120.100.154	100m.	525,00.-TL

KOD	SCHUKO 1x16A 4Ad.+3x2.5 TTR	BİRİM FİYAT
120.050.254	50 m.	485,00.-TL
120.100.254	100m.	700,00.-TL

PLASTİK GÖVDELİ KABLOLU MAKARALAR



KOD	SCHUKO 1x16A 4Ad.+3x1.5 TTR	BİRİM FİYAT
150.020.154	20m.	132,00.-TL
150.025.154	25m.	150,00.-TL
150.030.154	30m.	170,00.-TL
150.035.154	35m.	190,00.-TL
150.040.154	40m.	214,00.-TL
150.050.154	50m.	252,00.-TL

KOD	SCHUKO 1x16A 4Ad.+3x2.5 TTR	BİRİM FİYAT
150.020.254	20m.	176,00.-TL
150.025.254	25m.	204,00.-TL
150.030.254	30m.	235,00.-TL
150.035.254	35m.	265,00.-TL
150.040.254	40m.	300,00.-TL

KOD	4x25A 1 Ad.+1x16A 2Ad.+4x2.5 TTR	BİRİM FİYAT
160.020.254	20m.	258,00.-TL
160.025.254	25m.	300,00.-TL
160.030.254	30m.	340,00.-TL
160.035.254	35m.	380,00.-TL
160.040.254	40m.	420,00.-TL

PLASTİK GÖVDELİ KABLO MAKARALARI

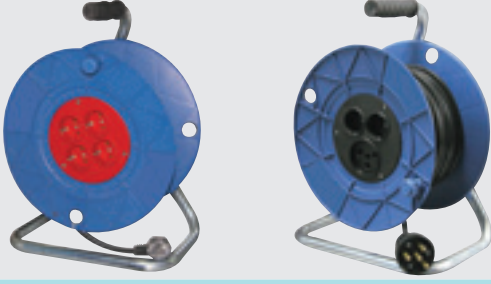

KOD	AÇIKLAMA	BİRİM FİYAT
150.000.04	Schuko 1x16A 4Ad.	50,00.-TL
160.425.12	4x25A 1Ad.+1x16A 2Ad.	73,00.-TL

METAL GÖVDELİ KABLO MAKARALARI

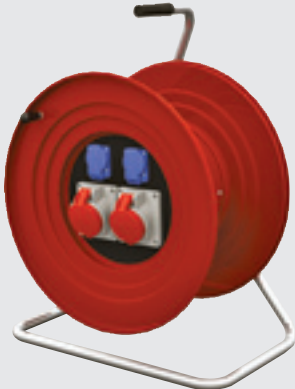

KOD	AÇIKLAMA	BİRİM FİYAT
100.000.004	Schuko 1x16A 4Ad.	89,00.-TL
100.000.004.T	Schuko 1x16A 4Ad.+Termikli	102,00.-TL
120.000.004	Schuko 1x16A 4Ad.	110,00.-TL
120.000.004.T	Schuko 1x16A 4Ad.+Termikli	123,00.-TL

KOD	AÇIKLAMA	BİRİM FİYAT
120.316.012	CEE 3x16A 1Ad.+1x16A 2Ad.	120,00.-TL
120.416.012	CEE 4x16A 1Ad.+1x16A 2Ad.	123,00.-TL
120.516.012	CEE 5x16A 1Ad.+1x16A 2Ad.	126,00.-TL
120.425.012	4x25A 1Ad.+1x16A 2Ad.	115,00.-TL
120.332.012	CEE 3x32A 1Ad.+1x16A 2Ad.	122,00.-TL
120.432.012	CEE 4x32A 1Ad.+1x16A 2Ad.	126,00.-TL
120.532.012	CEE 5x32A 1Ad.+1x16A 2Ad.	129,00.-TL

KOD	AÇIKLAMA	BİRİM FİYAT
130.316.021	CEE 3x16A 2Ad.+1x16A 1Ad.	138,00.-TL
130.416.012	CEE 4x16A 1Ad.+1x16A 2Ad.	133,00.-TL
130.416.021	CEE 4x16A 2Ad.+1x16A 2Ad.	142,00.-TL
130.516.012	CEE 5x16A 1Ad.+1x16A 2Ad.	138,00.-TL
130.516.021	CEE 5x16A 2Ad.+1x16A 1Ad.	149,00.-TL
130.425.012	4x25A 1Ad.+1x16A 2Ad.	129,00.-TL
130.425.021	4x25A 2Ad.+1x16A 1Ad.	132,00.-TL
130.332.012	CEE 3x32A 1Ad.+1x16A 2Ad.	138,00.-TL
130.432.012	CEE 4x32A 1Ad.+1x16A 2Ad.	140,00.-TL
130.532.012	CEE 5x32A 1Ad.+1x16A 2Ad.	145,00.-TL

KOD	AÇIKLAMA	BİRİM FİYAT
140.416.022	CEE 4x16A 2Ad.+1x16A 2Ad.	222,00.-TL
140.516.022	CEE 5x16A 2Ad.+1x16A 2Ad.	233,00.-TL
140.425.022	4x25A 2Ad.+1x16A 2Ad.	234,00.-TL
140.432.022	CEE 4x32A 2Ad.+1x16A 2Ad.	240,00.-TL
140.532.022	CEE 5x32A 2Ad.+1x16A 2Ad.	220,00.-TL

ARABALI ÖZEL MAKARALAR

ARABALI KABLO MAKARALARI



KOMBİNASYONLU KABLO MAKARALARI



PLASTİK PANOLU KABLO MAKARALARI



KOD	AÇIKLAMA	BİRİM FİYAT
101.000.004	Schuko 1x16A 4Ad.	325,00.-TL
121.000.004	Schuko 1x16A 4Ad.	345,00.-TL
121.316.012	CEE 3x16A 1Ad.+1x16A 2Ad.	352,00.-TL
121.416.012	CEE 4x16A 1Ad.+1x16A 2Ad.	356,00.-TL
121.516.012	CEE 5x16A 1Ad.+1x16A 2Ad.	365,00.-TL
121.425.012	4x25A 1Ad.+1x16A 2Ad.	352,00.-TL
121.332.012	CEE 3x32A 1Ad.+1x16A 2Ad.	365,00.-TL
121.432.012	CEE 4x32A 1Ad.+1x16A 2Ad.	368,00.-TL
121.532.012	CEE 5x32A 1Ad.+1x16A 2Ad.	372,00.-TL
131.316.021	CEE 3x16A 2Ad.+1x16A 1Ad.	375,00.-TL
131.416.012	CEE 4x16A 1Ad.+1x16A 2Ad.	372,00.-TL
131.416.021	CEE 4x16A 2Ad.+1x16A 1Ad.	380,00.-TL
131.516.012	CEE 5x16A 1Ad.+1x16A 2Ad.	375,00.-TL
131.516.021	CEE 5x16A 2Ad.+1x16A 1Ad.	385,00.-TL
131.425.012	4x25A 1Ad.+1x16A 2Ad.	372,00.-TL
131.425.021	4x25A 2Ad.+1x16A 1Ad.	376,00.-TL
131.332.012	CEE 3x32A 1Ad.+1x16A 2Ad.	376,00.-TL
131.432.012	CEE 4x32A 1Ad.+1x16A 2Ad.	375,00.-TL
131.532.012	CEE 5x32A 1Ad.+1x16A 2Ad.	380,00.-TL
141.416.022	CEE 4x16A 2Ad.+1x16A 2Ad.	425,00.-TL
141.516.022	CEE 5x16A 2Ad.+1x16A 2Ad.	430,00.-TL
141.432.022	CEE 4x32A 2Ad.+1x16A 2Ad.	433,00.-TL
141.532.022	CEE 5x32A 2Ad.+1x16A 2Ad.	442,00.-TL

KABLO KESİTİNE GÖRE MAKARALARIN KAPASİTESİ (m)

MAKARA CİNSİ	KABLO KESİTİ	100.XXX M100	120.XXX M200	130.XXX M300	140.XXX M400	PLASTİK	
						MONOFAZE 150.000.04	TRİFAZE 160.425.12
3 x 1.5	TTR	50	100	120	180	60	60
3 x 2.5	TTR	40	75	100	140	50	50
3 x 4	TTR	30	60	75	125	40	40
4 x 1.5	TTR		80	100	170		50
4 x 2.5	TTR		65	80	130		35
4 x 4	TTR		45	55	100		25
5 x 1.5	TTR		75	100	135		
5 x 2.5	TTR		50	70	110		
5 x 4	TTR		40	50	90		

*Arabalı Özel Makaralar için fiyat isteyiniz.

TAŞIYICI AYAK KÜÇÜK BOY



KOD	AÇIKLAMA	ÖLÇÜ (a x b)mm	1	BİRİM FİYAT
740.022.001	21x30 - 26x35 - 30x40 Panolar için Taşıyıcı Ayak	310 x 696	1	79,00.-TL

TAŞIYICI AYAK BÜYÜK BOY

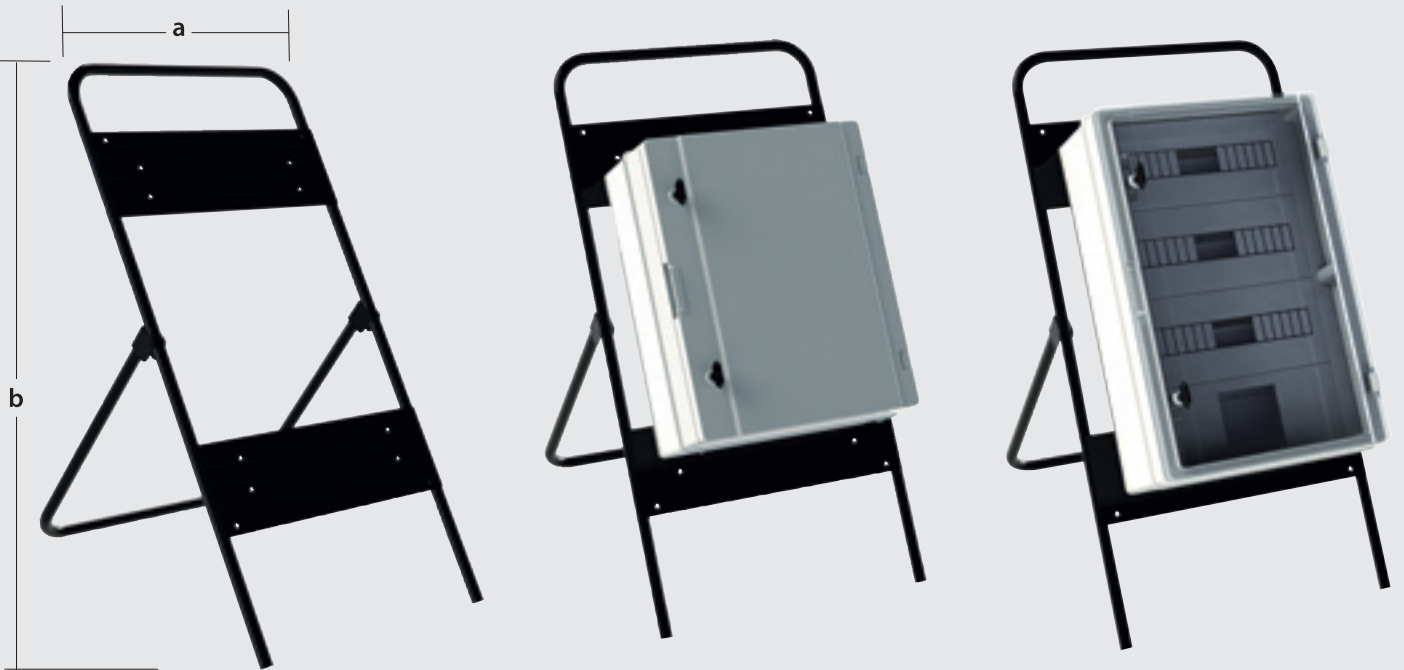

KOD	AÇIKLAMA	ÖLÇÜ (a x b)mm	1	BİRİM FİYAT
740.022.002	40x50 - 40x60 - 50x70 Panolar için Taşıyıcı Ayak	510 x 814	1	96,00.-TL

IP65

TABAN SACLI PLASTİK PANOLAR

(HALOJEN FREE)

KOD		ÖLÇÜ (cm)		BİRİM FİYAT	
OPAK KAPAK	ŞEFFAF KAPAK			OPAK KAPAK	ŞEFFAF KAPAK
910.2130.131.000	910.2130.132.000	21x30x13	20	54,00.-TL	62,00.-TL
910.2635.151.000	910.2635.152.000	26x35x15	12	66,00.-TL	76,00.-TL
910.3040.131.000	910.3040.132.000	30x40x13	10	84,00.-TL	105,00.-TL
910.3040.171.000	910.3040.172.000	30x40x17	8	86,00.-TL	107,00.-TL
910.3040.191.000	910.3040.192.000	30x40x19	8	98,00.-TL	119,00.-TL
910.3040.231.000	910.3040.232.000	30x40x23	8	110,00.-TL	131,00.-TL
910.4050.201.000	910.4050.202.000	40x50x20	6	145,00.-TL	172,00.-TL
910.4060.201.000	910.4060.202.000	40x60x20	6	155,00.-TL	193,00.-TL
910.5070.251.000	910.5070.252.000	50x70x25	4	282,00.-TL	340,00.-TL



910.4060.201.000



910.4060.202.000

IP65

PERDELİ PLASTİK PANOLAR

(HALOJEN FREE)

KOD		ÖLÇÜ (cm)		BİRİM FİYAT	
OPAK KAPAK	ŞEFFAF KAPAK			OPAK KAPAK	ŞEFFAF KAPAK
920.2130.131.016	920.2130.132.016	21x30x13 - 2x8 Sigortalı	20	75,00.-TL	83,00.-TL
920.2635.151.018	920.2635.152.018	26x35x15 - 2x9 Sigortalı	12	98,00.-TL	108,00.-TL
920.3040.131.024	920.3040.132.024	30x40x13 - 3x8 Sigortalı	10	128,00.-TL	149,00.-TL
920.3040.171.024	920.3040.172.024	30x40x17 - 3x8 Sigortalı	8	130,00.-TL	151,00.-TL
920.4050.201.048	920.4050.202.048	40x50x20 - 3x16 Sigortalı	6	200,00.-TL	227,00.-TL
920.4060.201.064	920.4060.202.064	40x60x20 - 4x16 Sigortalı	6	240,00.-TL	275,00.-TL
920.5070.251.100	920.5070.252.100	50x70x25 - 5x20 Sigortalı	4	420,00.-TL	478,00.-TL



920.5070.251.100



920.2635.151.018



920.4050.202.048



920.2635.152.018

* Panolarda kilitli anahtar istenildiğinde her kilit için net 8,50TL eklenir.

IP65 PERDELİ + KOMPAKT ŞALTERLİ PLASTİK PANOLAR (HALOJEN FREE)

KOD		ÖLÇÜ (cm)		BİRİM FİYAT	
OPAK KAPAK	ŞEFFAF KAPAK			OPAK KAPAK	ŞEFFAF KAPAK
922.4050.201.032	922.4050.202.032	40x50x20 - 2x16 Sigorta+1 Kompakt Şalter	6	200,00.-TL	227,00.-TL
922.4060.201.048	922.4060.202.048	40x60x20 - 3x16 Sigorta+1 Kompakt Şalter	6	240,00.-TL	275,00.-TL
922.5070.251.060	922.5070.252.060	50x70x25 - 3x20 Sigorta+1 Kompakt Şalter	4	420,00.-TL	478,00.-TL



922.4060.201.048



922.4060.202.048

IP65 MONOFAZE SAYAÇLI PLASTİK PANOLAR (HALOJEN FREE)

KOD		ÖLÇÜ (cm)		BİRİM FİYAT	
OPAK KAPAK	ŞEFFAF KAPAK			OPAK KAPAK	ŞEFFAF KAPAK
930.2130.131.003	930.2130.132.003	21x30x13 - Sayaç+3 Sigortalı	20	75,00.-TL	83,00.-TL
930.2635.151.003	930.2635.152.003	26x35x15 - Sayaç+3 Sigortalı	12	98,00.-TL	108,00.-TL
931.3040.131.015	931.3040.132.015	30x40x13 - Sayaç+15 Sigortalı	10	128,00.-TL	149,00.-TL
931.3040.171.015	931.3040.172.015	30x40x17 - Sayaç+15 Sigortalı	8	130,00.-TL	151,00.-TL
931.4050.201.224	931.4050.202.224	40x50x20 - 2 Sayaç+24 Sigortalı	6	200,00.-TL	227,00.-TL



931.3040.171.015



931.4050.201.224



930.2635.152.003

IP65

TRİFAZE SAYAÇLI PLASTİK PANOLAR

(HALOJEN FREE)

KOD		ÖLÇÜ (cm)		BİRİM FİYAT	
OPAK KAPAK	ŞEFFAF KAPAK			OPAK KAPAK	ŞEFFAF KAPAK
935.3040.131.008	935.3040.132.008	30x40x13 - Sayaç+8 Sigortalı	10	128,00.-TL	149,00.-TL
935.3040.171.008	935.3040.172.008	30x40x17 - Sayaç+8 Sigortalı	8	130,00.-TL	151,00.-TL
935.4050.201.008	935.4050.202.008	40x50x20 - Sayaç+8 Sigortalı	6	200,00.-TL	227,00.-TL
935.4060.201.008	935.4060.202.008	40x60x20 - Sayaç+8 Sigortalı	6	240,00.-TL	275,00.-TL
935.5070.251.008	935.5070.252.008	50x70x25 - Sayaç+8 Sigortalı	4	420,00.-TL	478,00.-TL
942.5070.251.000	942.5070.252.000	50x70x25 Akım Trafo+Kaçak Akım+Kompakt Şalter	4	420,00.-TL	478,00.-TL



935.4060.201.008



935.3040.172.008



942.5070.251.000

IP65

TRİFAZE SAYAÇ + DAĞITIMLI PLASTİK PANOLAR (HALOJEN FREE)

KOD		ÖLÇÜ (cm)		BİRİM FİYAT	
OPAK KAPAK	ŞEFFAF KAPAK			OPAK KAPAK	ŞEFFAF KAPAK
936.4050.201.024	936.4050.202.024	40x50x20 - Sayaç+24 Sigortalı	6	200,00.-TL	227,00.-TL
936.4060.201.040	936.4060.202.040	40x60x20 - Sayaç+40 Sigortalı	6	240,00.-TL	275,00.-TL
936.5070.251.068	936.5070.252.068	50x70x25 - Sayaç+68 Sigortalı	4	420,00.-TL	478,00.-TL



936.4050.201.024



936.5070.252.068

IP65

ŞANTIYE / PRİZ PANOLARI

(HALOJEN FREE)

KOD		ÖLÇÜ (cm)		BİRİM FİYAT	
OPAK KAPAK	ŞEFFAF KAPAK			OPAK KAPAK	ŞEFFAF KAPAK
965.4060.201.016	965.4060.202.016	40x60x20-Trifaze Sayaç+16 Sigorta+3 Priz Yeri	6	240,00.-TL	275,00.-TL
965.5070.251.040	965.5070.252.040	50x70x25-Trifaze Sayaç+40 Sigorta+4 Priz Yeri	4	420,00.-TL	478,00.-TL
965.5070.251.020	965.5070.252.020	50x70x25-Trifaze Sayaç+20 Sigorta+8 Priz Yeri	4	420,00.-TL	478,00.-TL
966.4050.201.032	966.4050.202.032	40x50x20 - 32 Sigorta+3 Priz Yeri	6	200,00.-TL	227,00.-TL
966.4060.201.048	966.4060.202.048	40x60x20 - 48 Sigorta+3 Priz Yeri	6	240,00.-TL	275,00.-TL
966.4060.201.032	966.4060.202.032	40x60x20 - 32 Sigorta+6 Priz Yeri	6	240,00.-TL	275,00.-TL
966.5070.251.060	966.5070.252.060	50x70x25 - 60 Sigorta+8 Priz Yeri	4	420,00.-TL	478,00.-TL
740.020.000		Pano Ayak	1	37,00.-TL	
740.030.030		30x40 Pano Çatı	1	26,00.-TL	
740.030.045		40x50 Pano Çatı	1	28,00.-TL	
740.030.046		40x60 Pano Çatı	1	28,00.-TL	
740.030.050		50x70 Pano Çatı	1	38,00.-TL	



965.5070.251.020



965.4060.201.016



966.4060.201.032



IP65

SULAMA PANOLARI

(HALOJEN FREE)

KOD		ÖLÇÜ (cm)		BİRİM FİYAT	
OPAK KAPAK	ŞEFFAF KAPAK			OPAK KAPAK	ŞEFFAF KAPAK
960.4050.201.000	960.4050.202.000	40x50x20 Voltmetre+Ampermetre+Sinyal	6	200,00.-TL	227,00.-TL
960.4060.201.000	960.4060.202.000	40x60x20 Voltmetre+Ampermetre+Sinyal	6	240,00.-TL	275,00.-TL
960.5070.251.000	960.5070.252.000	50x70x25 Voltmetre+Ampermetre+Sinyal	4	420,00.-TL	478,00.-TL



960.5070.251.000



960.4060.202.000

IP65

ŞANTIYE PANOSU

(HALOJEN FREE)

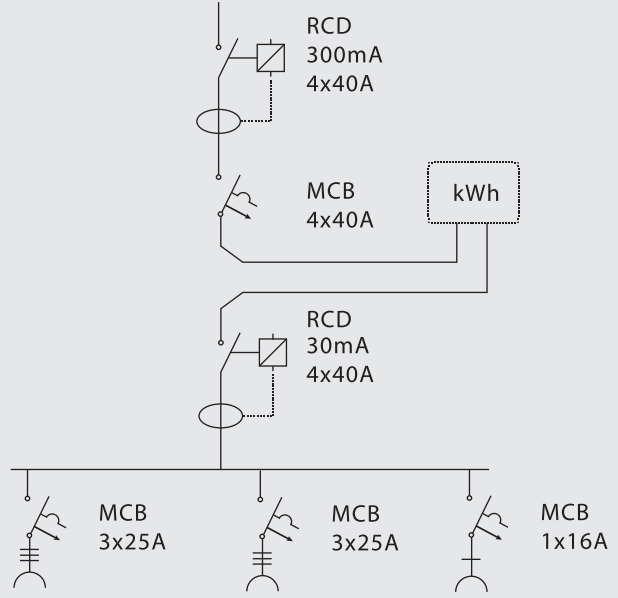

KOD		ÖLÇÜ (cm)	BİRİM FİYAT
OPAK KAPAK	ŞEFFAF KAPAK		
965.4060.201.016	965.4060.202.016	40x60x20 Trifaze Sayaç+16 Sigorta+3 Priz Yeri	6
			240,00.-TL
			275,00.-TL

IP65

TRİFAZE SAYAÇLI PANO

(HALOJEN FREE)

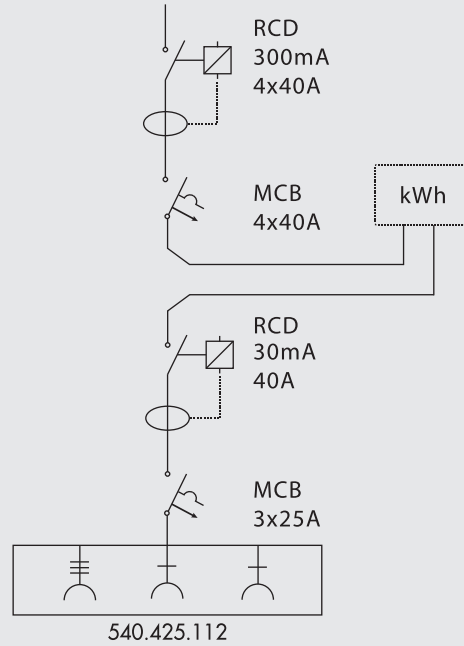

KOD		AÇIKLAMA / ÖLÇÜ (cm)	BİRİM FİYAT
OPAK KAPAK	ŞEFFAF KAPAK		
936.4050.201.112	936.4050.202.112	40x50x20 Sayaç+24 Sigortalı	6
			200,00.-TL
			227,00.-TL

IP65

ÖZEL PANOLAR

(HALOJEN FREE)

KOD		AÇIKLAMA / ÖLÇÜ (cm)		BİRİM FİYAT	
OPAK KAPAK	ŞEFFAF KAPAK			OPAK KAPAK	ŞEFFAF KAPAK
960.2635.151.000	960.2635.152.000	Asansör Panosu / 26x35x15	1	560,00.-TL	580,00.-TL
960.3040.131.000	960.3040.132.000	Asansör Panosu / 30x40x13	1	580,00.-TL	598,00.-TL
970.5070.251.035	970.5070.252.035	Kompanzasyon Panosu / 50x70x25	1	Fiyat Sorunuz.	Fiyat Sorunuz.



960.3040.131.000

Malzemeler

- 1Ad. 5x40A Pako - Emas
- 1Ad. 4x40A 300mA KAKR - Viko
- 1Ad. 2x25A 30mA KAKR - Viko
- 1Ad. C4x40A Otomatik Sigorta - Viko
- 3Ad. C1x16A Otomatik Sigorta - Viko
- 3Ad. ø22 Sinyal
- 1Ad. 1x16A Schuko Priz

35 kVAr**OTOMATİK + MANUEL****Malzemeler**

- Röle - Entes
- Kontaktör - Entes
- Kondansatör - Entes
- Sigorta - Legrand
- Sabit Grup 2,5 kVAr
- Otomatik Grup (2,5+6x5) kVAr



970.5070.251.035

IP65

KOFRA PANOLARI

KOD		ÖLÇÜ (cm)		BİRİM FİYAT	
OPAK KAPAK	ŞEFFAF KAPAK			OPAK KAPAK	ŞEFFAF KAPAK
923.2635.151.000	923.2635.152.000	26x35x15	12	110,00.-TL	125,00.-TL
923.3040.171.000	923.3040.172.000	30x40x17	8	140,00.-TL	158,00.-TL
923.4050.201.000	923.4050.202.000	40x50x20	6	220,00.-TL	248,00.-TL



923.2635.151.000



923.4050.201.000

OPAK KAPAKLI

950

951

952



950.2635.151.050

KOD	ÖLÇÜ (cm)		BOŞ B. FİYAT	ÇATILI B. FİYAT	ÇATI+REGLETİLİ B. FİYAT
950.2130.131.030	21x30x13 - Çatı+Regletli 30 Per	20	51,00.-TL	59,40.-TL	87,00.-TL
950.2635.151.050	26x35x15 - Çatı+Regletli 50 Per	12	57,50.-TL	71,50.-TL	117,50.-TL
950.3040.131.100	30x40x13 - Çatı+Regletli 100 Per	10	69,00.-TL	97,00.-TL	189,00.-TL
950.3040.171.100	30x40x17 - Çatı+Regletli 100 Per	8	71,00.-TL	99,00.-TL	191,00.-TL
950.4050.201.150	40x50x20 - Çatı+Regletli 150 Per	6	118,00.-TL	160,00.-TL	298,00.-TL
950.4050.201.200	40x50x20 - Çatı+Regletli 200 Per	6	118,00.-TL	174,00.-TL	358,00.-TL
950.4050.201.300	40x50x20 - Çatı+Regletli 300 Per	6	118,00.-TL	202,00.-TL	478,00.-TL
950.4060.201.400	40x60x20 - Çatı+Regletli 400 Per	6	123,00.-TL	235,00.-TL	603,00.-TL
950.5070.251.500	50x70x25 - Çatı+Regletli 500 Per	4	267,00.-TL	407,00.-TL	867,00.-TL



950.4050.201.200

ŞEFFAF KAPAKLI

950

951

952



950.2635.152.050

KOD	ÖLÇÜ (cm)		BOŞ B. FİYAT	ÇATILI B. FİYAT	ÇATI+REGLETİLİ B. FİYAT
950.2130.132.030	21x30x13 - Çatı+Regletli 30 Per	20	60,00.-TL	68,40.-TL	96,00.-TL
950.2635.152.050	26x35x15 - Çatı+Regletli 50 Per	12	68,50.-TL	82,50.-TL	128,50.-TL
950.3040.132.100	30x40x13 - Çatı+Regletli 100 Per	10	82,00.-TL	110,00.-TL	202,00.-TL
950.3040.172.100	30x40x17 - Çatı+Regletli 100 Per	8	84,00.-TL	112,00.-TL	204,00.-TL
950.4050.202.150	40x50x20 - Çatı+Regletli 150 Per	6	146,00.-TL	188,00.-TL	326,00.-TL
950.4050.202.200	40x50x20 - Çatı+Regletli 200 Per	6	146,00.-TL	202,00.-TL	386,00.-TL
950.4050.202.300	40x50x20 - Çatı+Regletli 300 Per	6	146,00.-TL	230,00.-TL	506,00.-TL
950.4060.202.400	40x60x20 - Çatı+Regletli 400 Per	6	156,00.-TL	268,00.-TL	636,00.-TL
950.5070.252.500	50x70x25 - Çatı+Regletli 500 Per	4	330,00.-TL	470,00.-TL	930,00.-TL

IP 65

PANO AKSESUARLARI



KOD	AÇIKLAMA		BİRİM FİYAT
740.010.001	Reglet - Kesmeli	100	9,30.-TL
740.010.002	Reglet - Kesmesiz	100	8,60.-TL
740.011.000	Çatı - Tekli	100	2,80.-TL
740.020.000	Pano Ayak	1	37,00.-TL
740.030.030	30x40 Pano Çatı	1	26,00.-TL
740.030.045	40x50 Pano Çatı	1	28,00.-TL
740.030.046	40x60 Pano Çatı	1	28,00.-TL
740.030.050	50x70 Pano Çatı	1	38,00.-TL

KABLO BAĞI

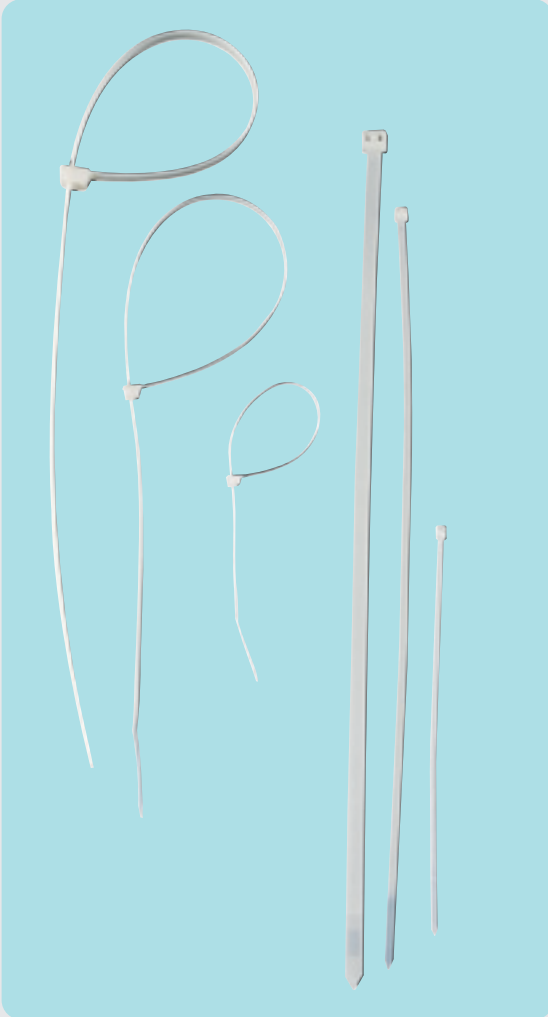

KOD	BOYUT (mm)		BİRİM FİYAT
736.230.210	2.5 x 100	100	0,0180.-TL
736.230.215	2.5 x 150	100	0,0320.-TL
736.230.220	2.5 x 200	100	0,0470.-TL
736.230.315	3.6 x 150	100	0,0470.-TL
736.230.320	3.6 x 200	100	0,0720.-TL
736.230.325	3.6 x 250	100	0,0840.-TL
736.230.330	3.6 x 300	100	0,1030.-TL
736.230.337	3.6 x 370	100	0,1280.-TL
736.230.419	4.8 x 190	100	0,0600.-TL
736.230.420	4.8 x 200	100	0,0900.-TL
736.230.425	4.8 x 250	100	0,1170.-TL
736.230.430	4.8 x 300	100	0,1400.-TL
736.230.436	4.8 x 360	100	0,1860.-TL
736.230.440	4.8 x 400	100	0,1950.-TL
736.230.443	4.8 x 430	100	0,2050.-TL
736.230.745	7.2 x 450	100	0,4410.-TL
736.230.755	7.6 x 550	100	0,6000.-TL
736.230.975	9.0 x 750	100	1,0500.-TL
736.230.990	9.0 x 900	100	1,5210.-TL

POLYESTER PANOLAR

- Duvar veya yer montajına uygun
- V₀ seviyesinde yanmazlık
- Kullanım sıcaklığı aralığı -30°C / +70°C
- Atmosferik etkilere dayanım
- Düz veya eğik çatı
- Kilitlenebilir kapak
- Terlemeyen yapı



OSZ 406024

IP54

KOD	ÖLÇÜ (mm)		BİRİM FİYAT
OSZ 264024	264 x 420 x 245	1	300,00.-TL
OSZ 404024	396 x 420 x 245	1	317,00.-TL
OSZ 405024	396 x 520 x 245	1	355,00.-TL
OSZ 406024	396 x 620 x 245	1	360,00.-TL
OSZ 536024	528 x 620 x 245	1	405,00.-TL
OSZ 538024	528 x 820 x 245	1	460,00.-TL
OSZ 668024(*)	660 x 820 x 245	1	602,00.-TL
KSZ 536032	528 x 620 x 320	1	470,00.-TL
KSZ 538032	528 x 820 x 320	1	548,00.-TL
OSZ808024	800 x 800 x 240	1	615,00.-TL

OSZ - 245mm derinlik
KSZ - 320mm derinlik



OW 405021

OW - Sıvaaltı kullanılabilir
OWU - Direğe bağlanabilir
ZN - Yatay tip
ZNU - Yatay tip direğe bağlanabilir

(*) Çift kapılı

(**) Direk montajına uygun



ZN 3028

IP54

KOD	ÖLÇÜ (mm)		BİRİM FİYAT
OW 404021	395 x 412 x 214	1	210,00.-TL
OW 405021	395 x 512 x 214	1	213,00.-TL
OW 406021	395 x 612 x 214	1	255,00.-TL
OWU 404021(**)	395 x 412 x 214	1	220,00.-TL
OWU 405021(**)	395 x 512 x 214	1	245,00.-TL
OWU 406021(**)	395 x 612 x 214	1	256,00.-TL
ZN 302811	395 x 412 x 214	1	92,00.-TL
ZNU 302811(**)	395 x 512 x 214	1	102,00.-TL

POLYESTER PANOLAR



IP54

KOD	ÖLÇÜ (mm)		BİRİM FİYAT
DCE0 608532	595 x 860 x 320	1	555,00.-TL
DCWE0 6011432(*)	605 x 1140 x 320	1	752,00.-TL
DCE1 798632(*)	790 x 860 x 320	1	843,00.-TL
DCWE1 6011433(*)	800 x 1140 x 320	1	843,00.-TL
DCE2 798633(*)	1120 x 860 x 320	1	964,00.-TL

DCE - DYN Norm

DCWE - DYN Norm çift kapaklı



IP65

H - IP65 Tip pano

KOD	ÖLÇÜ (mm)		BİRİM FİYAT
H 406027	438 x 618 x 214	1	472,00.-TL
H 608032 (**)	616 x 816 x 214	1	808,00.-TL

(*) Çift kapılı

(**) Direk montajına uygun

FIÇI TİP 1 kV BARA MESNET İZOLATÖRLERİ



Kör Somunlu
722.120.005



Cıvatalı
722.102.005



Cıvatalı + Kör Somunlu
722.111.005

KOD	AÇIKLAMA		BİRİM FİYAT
722.120.005	M5 Kör Somunlu Fiçi Tip	250	1,70.-TL
722.102.005	M5 Cıvatalı Fiçi Tip	250	1,10.-TL
722.111.005	M5 Cıvata+Kör Somunlu Fiçi Tip	250	1,50.-TL
722.120.008	M8 Kör Somunlu Fiçi Tip	50	4,00.-TL
722.102.008	M8 Cıvatalı Fiçi Tip	50	2,75.-TL
722.111.008	M8 Cıvata+Kör Somunlu Fiçi Tip	50	3,65.-TL
722.120.010	M10 Kör Somunlu Fiçi Tip	50	5,00.-TL
722.102.010	M10 Cıvatalı Fiçi Tip	50	3,30.-TL
722.111.010	M10 Cıvata+Kör Somunlu Fiçi Tip	50	4,60.-TL

KONİK TİP 1 kV BARA MESNET İZOLATÖRLERİ



Kör Somunlu
722.220.006



Cıvatalı
722.202.006



Cıvatalı + Kör Somunlu
722.211.006

KOD	AÇIKLAMA		BİRİM FİYAT
722.220.006	M6 Kör Somunlu Konik Tip	100	2,25.-TL
722.202.006	M6 Cıvatalı Konik Tip	100	1,80.-TL
722.211.006	M6 Cıvata+Kör Somunlu Konik Tip	100	2,00.-TL
722.220.008	M8 Kör Somunlu Konik Tip	50	4,80.-TL
722.202.008	M8 Cıvatalı Konik Tip	50	3,75.-TL
722.211.008	M8 Cıvata+Kör Somunlu Konik Tip	50	4,30.-TL
722.220.010	M10 Kör Somunlu Konik Tip	50	5,50.-TL
722.202.010	M10 Cıvatalı Konik Tip	50	4,20.-TL
722.211.010	M10 Cıvata+Kör Somunlu Konik Tip	50	5,00.-TL

TARAK İZOLATÖRLER

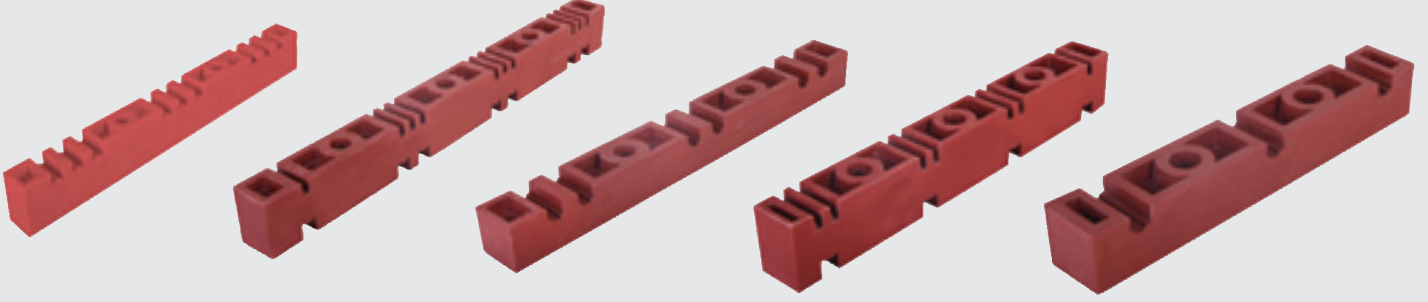

KOD	AÇIKLAMA		BİRİM FİYAT
722.331.000	Tek Bara Taraklı - Üç Fazlı	24	9,50.-TL
722.332.000	Çift Bara Taraklı - Üç Fazlı	24	12,50.-TL
722.333.000	Üç Bara Taraklı - Üç Fazlı	24	27,00.-TL
722.341.000	Tek Bara Taraklı - Üç Fazlı + Nötr	24	16,00.-TL
722.342.000	Çift Bara Taraklı - Üç Fazlı + Nötr	24	19,00.-TL

1N SERİSİ İZOLATÖRLER



KOD	AÇIKLAMA		BİRİM FİYAT
772.100.001	1N-B M16 Kör Somunlu	12	14,50.-TL
772.100.002	1N-C M16 Kör Somunlu	12	14,50.-TL
772.100.003	1N-D M16 Kör Somunlu	12	16,50.-TL
772.100.004	1N-K M16 Kör Somunlu	12	15,50.-TL
772.100.005	1N-500 M10 Kör Somunlu	12	9,00.-TL
773.000.008	Bara Tutucu Serfil	12	3,30.-TL



* Fiyatlarımıza K.D.V. dahil değildir.

* Sevk anındaki cari fiyatlar geçerlidir.

* 1.500.-TL üzeri siparişlerde ambar nakliyesi firmamıza aittir.

SEYYAR LAMBA - BALADOZ

ANAHTARLI BALADOZ



KOD	AÇIKLAMA	BİRİM FİYAT
785.000.010	Kablosuz	23,00.-TL
785.105.010	5m. Kablolu	34,00.-TL
785.110.010	10m. Kablolu	42,00.-TL
785.115.010	15m. Kablolu	53,00.-TL
785.120.010	20m. Kablolu	63,00.-TL
785.125.010	25m. Kablolu	73,00.-TL



ANAHTARSIZ BALADOZ

KOD	AÇIKLAMA	BİRİM FİYAT
785.000.020	Kablosuz	18,50.-TL
785.105.020	5m. Kablolu	29,00.-TL
785.110.020	10m. Kablolu	40,00.-TL
785.115.020	15m. Kablolu	47,00.-TL
785.120.020	20m. Kablolu	58,00.-TL
785.125.020	25m. Kablolu	67,00.-TL

SEYYAR LAMBA - ÇANAKLI BALADOZ

ANAHTARLI BALADOZ



KOD	AÇIKLAMA	BİRİM FİYAT
786.000.010	Kablosuz	40,00.-TL
786.107.010	7.5m. Kablolu	60,00.-TL



ANAHTARSIZ BALADOZ

KOD	AÇIKLAMA	BİRİM FİYAT
786.000.020	Kablosuz	35,00.-TL
786.107.020	7.5m. Kablolu	57,00.-TL

PRİZ KUTUSU

24V 100W



* Fiyat sorunuz.



BANT ARMATÜR SOKETLERİ

TEKLİ KLASİK
2,90.-TL/Tk.



787.100.100

ÇİFTLİ KLASİK
4,40.-TL/Tk.



787.100.200

STARTER YUVASI
1,20.-TL/Ad.



787.300.000

KABLolar

Çift Topraklı Fişli Kablo
3G 1,5 H0VV-F 3m.



725.315.113

Çift Topraklı Fişli Kablo
3G 2,5 H0VV-F 3m.



725.325.113

Güç Kablosu
3G 1 H0VV-F 1,8m.



725.310.212

İngiliz Fişli Kablo
3G 1,5 H0VV-F 3m.



725.315.123



* Kablolar için fiyat sorunuz.

**Satış Sorumluları**

Hüseyin Cahit Emekdar

İskan Erdoğan

Murat Çiftçi

Altan Urgancı

Ali Dinç

Bölgesi

İç Anadolu-Doğu Anadolu-Karadeniz-Güneydoğu Anadolu

Sefaköy-Avcılar-Pendik-Kocaeli-Yalova-Bursa

Beylikdüzü-Hadımköy-Arnautköy-Trakya Bölgesi-Sakarya
Bilecik-Eskişehir-Kütahya

Ege Bölgesi-Akdeniz Bölgesi

Bayrampaşa-Karaköy-Perpa-İstanbul Anadolu Yakası
Düzce-Bolu**Telefon**

0530 541 97 01

0532 417 31 86

0531 381 04 38

0533 694 10 19

0535 107 70 65

Mail

cahit@temteknik.com

iskanerdogmus@temteknik.com

muratciftci@temteknik.com

altanurganci@temteknik.com

alidinc@temteknik.com

TEM®

TEM TEKNİK ELEKTRİK MALZEMELERİ SANAYİ VE TİCARET ANONİM ŞİRKETİ

Ortaköy Sanayi Bölgesi, İler Bulvarı, Yeldeğirmeni Caddesi, Mormenekşe Sokak, No:5

Selimpaşa / Silivri / İstanbul / TÜRKİYE

T. +90 212 485 19 00 Pbx F. +90 212 485 15 33

www.temteknik.com • info@temteknik.com • export@temteknik.com