

2018  
FİYAT LİSTESİ  
PRICE LIST





36kV



1kV



**tamflex**

36kV

Yeni  
3 Cidarlı



Yarı İletken tabaka  
Kauçuk tabaka  
PE tabaka

## HAKKIMIZDA ABOUT US

**1**975 yılında Hasan TAMER tarafından Ankara'da elektrik dağıtım tesisatında kullanılan sac ürünleri imalatı ile iş hayatına başlamıştır. 1980 yılına kadar süren sac imalatı sonrası, halen sürmekte olan elektrik sarf malzemelerinin toptan ve perakende satışını sürdürmüştür.

1996 yılında Ostim 'de imalat çalışmalarına başlanmış ve bugün Sarayköy-Kazanda 8200 m<sup>2</sup> kapalı alanında üretimlerine devam etmektedir. Yapısında seçkin kadrosuyla 1996 yılından günümüze üretimde çeşitliliğe gidilmiş, bu kapsamda 2000 yılında ISO 9001 Kalite Yönetim Sistemi belgesini bünyesine kazandırmıştır. Akabinde 2007 de ISO 14001 Çevre Yönetim Sistemi belgesini, 2014 te OHSAS 18001 İş Sağlığı ve Güvenliği Yönetim Sistemi belgesi, RoHS belgeleri, TSE ürün belgeleri, CE belgeleri ve ürünler ile ilgili uluslararası test belgeleri bulundurmaktadır.

Ürün gamında; Alçak ve Orta gerilim sınıfı dahilinde; reçineli, ısı büzümeli kablo ek muflarını, reçineli, ısı büzümeli ve silikon kablo başlıklarını, sıkmalı kablo pabuçları, sıkmalı ek mufları, Protolin ve ProSil yalıtım sıvılarını, AG&OG Buşing ve VHD kapama, havai hat izolasyon kapama malzemelerini üretmektedir. 2011 yılı başı ile Türkiye'de bir ilk olan "Isı Büzümeli Boru" üretimine geçerek bir ilki gerçekleştirmiş ve Türkiye için ufak, kendi için büyük bir yeniliğe imza atmıştır.

2018 yılında TAMGRUP ışınlama tesisini faaliyete alarak, Türkiye'de elektron hızlandırıcı (e-beam) tesisi kurarak yerli üretimde ki gücünü ve yerli üretime olan katkısını artırmıştır. Yalıtım alanında, kablo eklerinde, kablo başlıklarında ve aksesuarları üretiminde kaliteden taviz vermeden, müşteri memnuniyetinin üst seviyede tutulması ilkesine olan bağlılığını sürdürmeye devam edecektir.



The company was founded by Hasan TAMER in Ankara in 1975 for the manufacturing of metal sheet products used in electricity distribution networks. After the manufacturing of metal sheets which continued until the year 1980, the company has started dealing with the wholesale and retail marketing of the electricity products which is still continuing today.

The manufacturing works were started in 1996 in Ostim and now it is continuing in Sarayköy-Kazan within a closed area of 8200 m<sup>2</sup>. The variety of the range of products has been given utmost care by the expert staff from the year 1996 and in this respect; ISO 9001 Quality certificate was received by the company and pursuant to this ISO 9001 Environmental Management System certificate was received in 2007, OHSAS 18001 occupational health and safety management system certification received in 2014 and the company also has RoHS documents, all TSE Product certificates, CE certificates, international test report for products.

The product range of the company is composed of; Low and medium voltage class, resin, heat shrinkable cable joints and resin, heat shrinkable and silicon terminations, compressive cable lugs, compressive cable connectors, Protolin and Prosil insulation fluids, LV & MV Bushing and VHD covering, overhead-line protection. By the beginning of the year 2011, the company started the manufacturing of "heat shrinkable tubes" which was an innovation and has taken a small step for Turkey but a large step for itself. The irradiation facility TAMGRUP taking activities. In 2018, the power of the electron accelerator by establishing local production facilities in Turkey and increased its contribution to domestic production.

The company will always fulfill its principle of keeping the customer satisfaction at utmost level without ignoring the quality in the sector of insulation and in manufacturing of the cable end sleeves and accessories.





**Hayata Bağlar...**  
Connects to Life



# TAMER

varsa

o Őehirde hayat var...



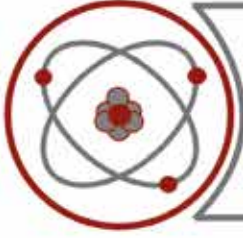

# TAM GRUP

Enerji İnşaat Işınlama  
San.Tic.Ltd.Şti.

[www.tamgrup.com.tr](http://www.tamgrup.com.tr)

2011 yılında kurulmuş olan şirketimiz, enerji, inşaat ve ışınlama alanlarında hizmet vermek, yapısında ileri teknolojik cihaz, ekipman desteği ile müşterilerine güvenilir ve hızlı bir şekilde hizmet vermek amacıyla kurulmuştur.

Bünyesinde 3MeV'lik elektron hızlandırıcı ile ürünler üzerinde de çapraz bağlama yaparak hizmet vermektedir.

Ürünlerin kalitesini artırmak, yarı mamulleri tam mamul olarak hizmete geçirmek amaçlı kullanılmaktadır.

1. Polimer Malzemeler
2. Kablo Sanayi
3. Otomotiv Sanayi
4. Lastik Sanayi
5. Ağaç ve Plastik Endüstrisi
6. Ahşap + Plastik Kompozit Malzeme
7. Motor Sanayi
8. Savunma Sanayi

**TÜRKİYE'NİN  
İLK 3MeV ELEKTRON  
HIZLANDIRICI  
TESİSİ**



### Avantajları nelerdir?

- Ürünlerin fiziki dayanımı artmakta.
- Malzeme ömrünü uzatır.
- Malzemelere form verilebilmektedir.
- Hızlı servis ile zamandan tasarruf
- Ekonomik maliyet.
- Ürün kalitesinde artış sağlama.



**t/e TAMER  
ELEKTRİK**







Reçineli Ek Mufları

09 →

Protolinler

21 →

İzolasyon Kapamalar

23 →

Isı Büzüşmeli Ek Muflar

25 →

AG Kablo Başlıkları

43 →

OG Isı Büzüşmeli Kablo Başlıkları

47 →

Silikon Kablo Başlıkları

59 →

SKP & SEM

65 →

Isı Büzüşmeli Borular

69 →

Aksesuarlar

73 →



0.6-1 kV

KOD CODE	KABLO KESİTİ CROSS SECTION	ADET/KOLİ UNIT/BOX	FİYAT PRICE
E1 4105 - E1 4205	4 x 1,5 - 4 x 2,5	60	39,60 ₺
E1 404 - E1 406	4 x 4 - 4 x 6	60	39,60 ₺
E1 515 - E1 5205	5 x 1,5 - 5 x 2,5	60	43,70 ₺
E1 504 - E1 506	5 x 4 - 5 x 6	60	43,70 ₺
E1 715 - E1 725	7 x 1,5 - 7 x 2,5	60	67,55 ₺

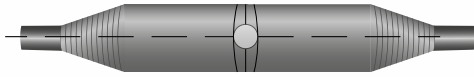

0.6-1 kV

KOD CODE	KABLO KESİTİ CROSS SECTION	ADET/KOLİ UNIT/BOX	FİYAT PRICE
E1 215 - E1 204	2 x 1,5 - 2 x 4	60	36,70 ₺
E1 206	2 x 6	60	36,70 ₺
E1 210	2 x 10	27	58,75 ₺
E1 216 - E1 225	2 x 16 - 2 x 25	27	58,75 ₺
E1 235 - E1 250	2 x 35 - 2 x 50	27	64,50 ₺
E1 270 - E1 295	2 x 70 - 2 x 95	18	88,35 ₺
E1 2120 - E1 2150	2 x 120 - 2 x 150	12	156,95 ₺
E1 2185	2 x 185	4	163,70 ₺
E1 2240	2 x 240	4	177,90 ₺



0.6-1 kV

KOD CODE	KABLO KESİTİ CROSS SECTION	ADET/KOLİ UNIT/BOX	FİYAT PRICE
E1 410	4 x 10	27	61,45 ₺
E1 416	4 x 16	27	62,80 ₺
E1 31610	3 x 16 + 10	27	62,20 ₺
E1 32516	3 x 25 + 16	27	65,50 ₺
E1 33516	3 x 35 + 16	27	68,75 ₺
E1 35025	3 x 50 + 25	27	71,65 ₺
E1 425	4 x 25	27	66,85 ₺
E1 435	4 x 35	27	70,15 ₺
E1 450	4 x 50	27	72,85 ₺
E1 510-E1 516	5 x 10 - 5 x 16	27	65,20 ₺



0.6-1 kV

KOD CODE	KABLO KESİTİ CROSS SECTION	ADET/KOLİ UNIT/BOX	FİYAT PRICE
E1 115 - E1 104	1 x 1,5 - 1 x 4	60	36,10 ₺
E1 106	1 x 6	60	36,10 ₺
E1 110	1 x 10	60	42,55 ₺
E1 116 - E1 125	1 x 16 - 1 x 25	60	42,55 ₺
E1 135 - E1 150	1 x 35 - 1 x 50	60	45,90 ₺
E1 170 - E1 195	1 x 70 - 1 x 95	60	49,10 ₺
E1 1120 - E1 1150	1 x 120 - 1 x 150	40	65,50 ₺
E1 1185	1 x 185	40	81,90 ₺
E1 1240	1 x 240	40	84,65 ₺
E1 1300	1 x 300	24	109,50 ₺
E1 1400	1 x 400	24	115,00 ₺
E1 1500	1 x 500	24	124,00 ₺



0.6-1 kV

KOD CODE	KABLO KESİTİ CROSS SECTION	ADET/KOLİ UNIT/BOX	FİYAT PRICE
E1 315 - E1 304	3 x 1,5 - 3 x 4	60	38,20 ₺
E1 306	3 x 6	60	38,20 ₺
E1 310	3 x 10	27	59,00 ₺
E1 316	3 x 16	27	60,60 ₺
E1 325	3 x 25	27	62,20 ₺
E1 335	3 x 35	27	65,50 ₺
E1 350	3 x 50	27	67,55 ₺

\* İstenilen Kablo Kesitlerine Göre Ek Yapılır. / \* Produce Joint According To Demand

# BAKIR İLETKENLER İÇİN REÇİNELİ KABLO EK MUFLARI

FOR COPPER CONNECTORS RESIN CABLE JOINT



0.6-1 kV

KOD CODE	KABLO KESİTİ CROSS SECTION	ADET/KOLİ UNIT/BOX	FİYAT PRICE
E1 37035	3 x 70 + 35	24	114,60 ₺
E1 39550	3 x 95 + 50	24	120,00 ₺
E1 470	4 x 70	24	118,00 ₺
E1 495	4 x 95	24	122,75 ₺
E1 525	5 x 25	24	115,00 ₺
E1 535	5 x 35	24	117,00 ₺
E1 550	5 x 50	24	120,00 ₺



0.6-1 kV

KOD CODE	KABLO KESİTİ CROSS SECTION	ADET/KOLİ UNIT/BOX	FİYAT PRICE
E1 370	3 x 70	18	113,35 ₺
E1 395	3 x 95	18	118,60 ₺



0.6-1 kV

KOD CODE	KABLO KESİTİ CROSS SECTION	ADET/KOLİ UNIT/BOX	FİYAT PRICE
E1 31207	3 x 120 + 70	10	191,00 ₺
E1 31507	3 x 150 + 70	10	199,50 ₺
E1 4120	4 x 120	10	199,00 ₺
E1 4150	4 x 150	10	207,50 ₺
E1 570	5 x 70	10	192,00 ₺
E1 595	5 x 95	10	200,00 ₺

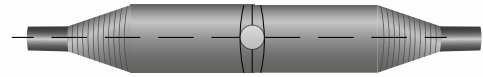

0.6-1 kV

KOD CODE	KABLO KESİTİ CROSS SECTION	ADET/KOLİ UNIT/BOX	FİYAT PRICE
E1 3120	3 x 120	10	189,00 ₺
E1 3150	3 x 150	10	197,00 ₺



0.6-1 kV

KOD CODE	KABLO KESİTİ CROSS SECTION	ADET/KOLİ UNIT/BOX	FİYAT PRICE
E1 31859	3 x 185 + 95	4	294,50 ₺
E1 32401	3 x 240 + 120	4	316,50 ₺
E1 4185	4 x 185	4	302,90 ₺
E1 4240	4 x 240	4	316,50 ₺
E1 5120	5 x 120	4	296,00 ₺
E1 5150	5 x 150	4	305,00 ₺



0.6-1 kV

KOD CODE	KABLO KESİTİ CROSS SECTION	ADET/KOLİ UNIT/BOX	FİYAT PRICE
E1 3185	3 x 185	4	292,50 ₺
E1 3240	3 x 240	4	314,50 ₺



0.6-1 kV

KOD CODE	KABLO KESİTİ CROSS SECTION	ADET/KOLİ UNIT/BOX	FİYAT PRICE
AE1 4015 - AE1 4025	4 x 1,5 - 4 x 2,5	60	38,00 ₺
AE1 404 - AE1 406	4 x 4 - 4 x 6	60	38,00 ₺
AE1 515 - AE1 525	5 x 1,5 - 5 x 2,5	60	42,55 ₺
AE1 504 - AE1 506	5 x 4 - 5 x 6	60	42,55 ₺
AE1 715 - AE1 725	7 x 1,5 - 7 x 2,5	60	65,50 ₺



0.6-1 kV

KOD CODE	KABLO KESİTİ CROSS SECTION	ADET/KOLİ UNIT/BOX	FİYAT PRICE
AE1 215 - AE1 204	2 x 1,5 - 2 x 4	60	35,55 ₺
AE1 206	2 x 6	60	35,55 ₺
AE1 210	2 x 10	27	57,50 ₺
AE1 216 - AE1 225	2 x 16 - 2 x 25	27	58,65 ₺
AE1 235 - AE1 250	2 x 35 - 2 x 50	27	63,50 ₺
AE1 270 - AE1 295	2 x 70 - 2 x 95	18	87,20 ₺
AE1 2120 - AE1 2150	2 x 120 - 2 x 150	12	155,80 ₺
AE1 2185	2 x 185	4	162,55 ₺
AE1 2240	2 x 240	4	176,75 ₺

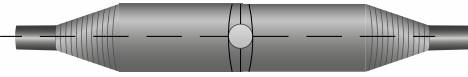

0.6-1 kV

KOD CODE	KABLO KESİTİ CROSS SECTION	ADET/KOLİ UNIT/BOX	FİYAT PRICE
AE1 410	4 x 10	27	60,30 ₺
AE1 416	4 x 16	27	61,65 ₺
AE1 31610	3 x 16 + 10	27	61,00 ₺
AE1 32516	3 x 25 + 16	27	64,05 ₺
AE1 33516	3 x 35 + 16	27	67,50 ₺
AE1 35025	3 x 50 + 25	27	70,00 ₺
AE1 425	4 x 25	27	66,00 ₺
AE1 435	4 x 35	27	69,70 ₺
AE1 450	4 x 50	27	72,00 ₺
AE1 510 - AE1 516	5 x 10 - 5 x 16	27	63,20 ₺



0.6-1 kV

KOD CODE	KABLO KESİTİ CROSS SECTION	ADET/KOLİ UNIT/BOX	FİYAT PRICE
AE1 115 - AE1 104	1 x 1,5 - 1 x 4	60	35,00 ₺
AE1 106	1 x 6	60	35,00 ₺
AE1 110	1 x 10	60	41,40 ₺
AE1 116- 125	1 x 16 - 1 x 25	60	41,40 ₺
AE1 135 -AE1 150	1 x 35 - 1 x 50	60	48,00 ₺
AE1 170 - AE1 195	1 x 70 - 1 x 95	60	48,00 ₺
AE1 1120 - AE1 1150	1 x 120 - 1 x150	40	64,35 ₺
AE1 1185	1 x 185	40	80,75 ₺
AE1 1240	1 x 240	40	83,50 ₺
AE1 1300	1 x 300	24	108,00 ₺
AE1 1400	1 x 400	24	112,70 ₺
AE1 1500	1 x 500	24	121,90 ₺

# ALÜMİNYUM İLETKENLER İÇİN REÇİNELİ KABLO EK MUFLARI

FOR ALUMINUM CONNECTORS RESIN CABLE JOINTS



0.6-1 kV

KOD CODE	KABLO KESİTİ CROSS SECTION	ADET/KOLİ UNIT/BOX	FİYAT PRICE
AE1 32516	3 x 25 + 16	27	64,05 ₺
AE1 33516	3 x 35 + 16	27	67,50 ₺
AE1 35025	3 x 50 + 25	27	70,00 ₺
AE1 425	4 x 25	27	66,00 ₺
AE1 435	4 x 35	27	69,70 ₺
AE1 450	4 x 50	27	72,10 ₺



0.6-1 kV

KOD CODE	KABLO KESİTİ CROSS SECTION	ADET/KOLİ UNIT/BOX	FİYAT PRICE
AE1 325	3 x 25	27	60,85 ₺
AE1 335	3 x 35	27	64,00 ₺
AE1 350	3 x 50	27	66,25 ₺



0.6-1 kV

KOD CODE	KABLO KESİTİ CROSS SECTION	ADET/KOLİ UNIT/BOX	FİYAT PRICE
AE1 525	5 x 25	18	115,00 ₺
AE1 535	5 x 35	18	116,00 ₺
AE1 550	5 x 50	18	119,00 ₺



0.6-1 kV

KOD CODE	KABLO KESİTİ CROSS SECTION	ADET/KOLİ UNIT/BOX	FİYAT PRICE
AE1 370	3 x 70	18	110,55 ₺
AE1 395	3 x 95	18	113,35 ₺



0.6-1 kV

KOD CODE	KABLO KESİTİ CROSS SECTION	ADET/KOLİ UNIT/BOX	FİYAT PRICE
AE1 31207	3 x 120 + 70	10	189,00 ₺
AE1 31507	3 x 150 + 70	10	198,00 ₺
AE1 37035	3 x 70 + 35	18	113,35 ₺
AE1 39550	3 x 95 + 50	18	116,00 ₺
AE1 470	4 x 70	18	116,60 ₺
AE1 495	4 x 95	18	122,00 ₺
AE1 4120	4 x 120	10	197,00 ₺
AE1 4150	4 x 150	10	206,00 ₺
AE1 570	5 x 70	10	191,00 ₺
AE1 595	5 x 95	10	199,00 ₺

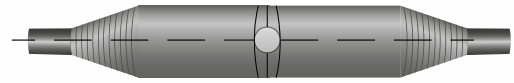

0.6-1 kV

KOD CODE	KABLO KESİTİ CROSS SECTION	ADET/KOLİ UNIT/BOX	FİYAT PRICE
AE1 3120	3 x 120	10	185,00 ₺
AE1 3150	3 x 150	10	196,00 ₺



0.6-1 kV

KOD CODE	KABLO KESİTİ CROSS SECTION	ADET/KOLİ UNIT/BOX	FİYAT PRICE
AE1 31859	3 x 185 + 95	4	292,00 ₺
AE1 32401	3 x 240 + 120	4	307,00 ₺
AE1 4185	4 x 185	4	301,00 ₺
AE1 4240	4 x 240	4	315,00 ₺
AE1 5120	5 x 120	4	295,00 ₺
AE1 5150	5 x 150	4	303,00 ₺



0.6-1 kV

KOD CODE	KABLO KESİTİ CROSS SECTION	ADET/KOLİ UNIT/BOX	FİYAT PRICE
AE1 3185	3 x 185	4	290,60 ₺
AE1 3240	3 x 240	4	304,00 ₺

\* İstenilen kablo kesitlerine göre ek yapılır. / \* Produce joint according to demand

## REÇİNELİ KABLO EK MUFLARI

*Güç yalıtımlı bağlantılarda,  
yer altı, yer üstü enerji kabloları,  
ve telefon bağlantısında  
güvenilir çözüm*



# ŞEFFAF REÇİNELİ KABLO EK MUFLARI

TRANSPARENT RESIN CABLE JOINTS

Reçineli  
Ek Muflar



0.6-1 kV

KOD CODE	KABLO KESİTİ CROSS SECTION	KOLİ ADETİ UNIT / BOX	FİYAT PRICE
ŞE1 410	4 x 10	40	60,00 ₺
ŞE1 416	4 x 16	40	60,00 ₺
ŞE1 425	4 x 25	40	62,80 ₺
ŞE1 31610	3 x 16 + 10	40	60,00 ₺
ŞE1 32516	3 x 25 + 16	40	61,35 ₺
ŞE1 1015-ŞE1 10205	10 x 1,5-10 x 2,5	40	75,00 ₺
ŞE1 1004-ŞE1 1006	10 x 4-10 x 6	40	75,00 ₺



0.6-1 kV

KOD CODE	KABLO KESİTİ CROSS SECTION	KOLİ ADETİ UNIT / BOX	FİYAT PRICE
ŞE1 435	4 x 35	20	145,20 ₺
ŞE1 450	4 x 50	20	145,20 ₺
ŞE1 470	4 x 70	20	150,40 ₺
ŞE1 495	4 x 95	20	154,30 ₺
ŞE1 33516	3 x 35 + 16	20	143,75 ₺
ŞE1 35025	3 x 50 + 25	20	146,50 ₺
ŞE1 37035	3 x 70 + 35	20	149,00 ₺
ŞE1 39550	3 x 95 + 50	20	151,70 ₺
ŞE1 2415-ŞE1 24205	24 x 1,5-24 x 2,5	20	112,60 ₺



0.6-1 kV

KOD CODE	KABLO KESİTİ CROSS SECTION	KOLİ ADETİ UNIT / BOX	FİYAT PRICE
TE1 410	4 x 10	10	163,70 ₺
TE1 416	4 x 16	10	163,70 ₺
TE1 425	4 x 25	10	171,90 ₺
TE1 31610	3 x 16 + 10	10	163,70 ₺
TE1 32516	3 x 25 + 16	10	171,90 ₺

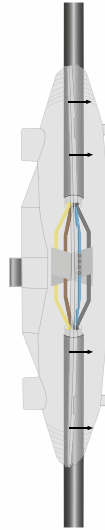

T TİP NO:2  
T TYPE

0.6-1 kV

KOD CODE	KABLO KESİTİ CROSS SECTION	KOLİ ADETİ UNIT / BOX	FİYAT PRICE
TE1 435	4 x 35	10	260,60 ₺
TE1 450	4 x 50	10	263,35 ₺
TE1 470	4 x 70	10	266,00 ₺
TE1 33516	3 x 35 + 16	10	259,15 ₺
TE1 35025	3 x 50 + 25	10	261,90 ₺
TE1 37035	3 x 70 + 35	10	264,80 ₺



0.6-1 kV

KOD CODE	KABLO KESİTİ CROSS SECTION	ADET/KOLİ UNIT/BOX	FİYAT PRICE
TE1 495	4 x 95	1	398,00 ₺
TE1 4120	4 x 120	1	405,00 ₺
TE1 4150	4 x 150	1	410,00 ₺
TE1 4185	4 x 185	1	415,00 ₺
TE1 4240	4 x 240	1	420,00 ₺
TE1 39550	3 x 95 + 50	1	393,00 ₺
TE1 31207	3 x 120 + 70	1	400,00 ₺
TE1 31507	3 x 150 + 70	1	405,00 ₺
TE1 31859	3 x 185 + 95	1	410,00 ₺
TE1 32401	3 x 240 + 120	1	415,00 ₺

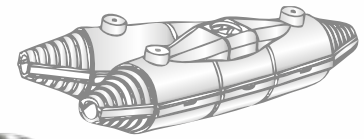

0.6-1 kV

KOD CODE	KABLO KESİTİ CROSS SECTION	Y. ÇIKIŞ KESİTİ BRANCH SECTION	FİYAT PRICE
YE1 11615	1 x 16	1 x 1,5	51,40 ₺
YE1 12516	1 x 25	1 x 16	54,55 ₺
YE1 13525	1 x 35	1 x 25	54,55 ₺
YE1 15035	1 x 50	1 x 35	62,80 ₺
YE1 17050	1 x 70	1 x 50	62,80 ₺
YE1 19570	1 x 95	1 x 70	73,70 ₺
YE1 112095	1 x 120	1 x 95	73,70 ₺
YE1 41515	4 x 1,5	4 x 1,5	81,80 ₺
YE1 42515	4 x 2,5	4 x 1,5	81,80 ₺
YE1 44015	4 x 4	4 x 1,5	81,80 ₺
YE1 41015	4 x 10	4 x 1,5	81,80 ₺

\* İstenilen kablo kesitlerine göre ek yapılır. / \* Produce joint according to demand



0.6-1 kV

KOD CODE	KABLO KESİTİ CROSS SECTION	FİYAT PRICE
VDE1 410	4 x 10	105,00 ₺
VDE1 416	4 x 16	105,00 ₺
VDE1 425	4 x 25	110,00 ₺
VDE1 31610	3 x 16 + 10	105,00 ₺
VDE1 32516	3 x 25 + 16	110,00 ₺



0.6-1 kV

KOD CODE	KABLO KESİTİ CROSS SECTION	FİYAT PRICE
VDEX1 410	4 x 10	75,00 ₺
VDEX1 416	4 x 16	75,00 ₺
VDEX1 425	4 x 25	79,00 ₺
VDEX1 31610	3 x 16 + 10	75,00 ₺
VDEX1 32516	3 x 25 + 16	79,00 ₺



0.6-1 kV

KOD CODE	KABLO KESİTİ CROSS SECTION	FİYAT PRICE
VDE1 435	4 x 35	178,00 ₺
VDE1 450	4 x 50	178,00 ₺
VDE1 470	4 x 70	185,00 ₺
VDE1 33516	3 x 35 + 16	178,00 ₺
VDE1 35025	3 x 50 + 25	178,00 ₺
VDE1 37035	3 x 70 + 35	185,00 ₺



0.6-1 kV

KOD CODE	KABLO KESİTİ CROSS SECTION	FİYAT PRICE
VDEX1 435	4 x 35	125,00 ₺
VDEX1 450	4 x 50	125,00 ₺
VDEX1 470	4 x 70	129,00 ₺
VDEX1 33516	3 x 35 + 16	125,00 ₺
VDEX1 35025	3 x 50 + 25	125,00 ₺
VDEX1 37035	3 x 70 + 35	129,00 ₺



0.6-1 kV

KOD CODE	KABLO KESİTİ CROSS SECTION	FİYAT PRICE
VDE1 495	4 x 95	226,00 ₺
VDE1 4120	4 x 120	285,00 ₺
VDE1 4150	4 x 150	320,00 ₺
VDE1 4185	4 x 185	320,00 ₺
VDE1 4240	4 x 240	320,00 ₺
VDE1 39550	3 x 95 + 50	226,00 ₺
VDE1 31207	3 x 120 + 70	285,00 ₺
VDE1 31507	3 x 150 + 70	320,00 ₺
VDE1 31859	3 x 185 + 95	320,00 ₺
VDE1 32401	3 x 240 + 120	320,00 ₺



0.6-1 kV

KOD CODE	KABLO KESİTİ CROSS SECTION	FİYAT PRICE
VDEX1 495	4 x 95	150,00 ₺
VDEX1 4120	4 x 120	204,00 ₺
VDEX1 4150	4 x 150	204,00 ₺
VDEX1 4185	4 x 185	204,00 ₺
VDEX1 4240	4 x 240	204,00 ₺
VDEX1 39550	3 x 95 + 50	150,00 ₺
VDEX1 31207	3 x 120 + 70	204,00 ₺
VDEX1 31507	3 x 150 + 70	217,00 ₺
VDEX1 31859	3 x 185 + 95	217,00 ₺
VDEX1 32401	3 x 240 + 120	217,00 ₺





0.6-1 kV

KOD CODE	KABLO KESİTİ CROSS SECTION	FİYAT PRICE
VYE1 410	4 x 10	128,00 ₺
VYE1 416	4 x 16	128,00 ₺
VYE1 425	4 x 25	133,00 ₺
VYE1 31610	3 x 16 + 10	128,00 ₺
VYE1 32516	3 x 25 + 16	133,00 ₺



0.6-1 kV

KOD CODE	KABLO KESİTİ CROSS SECTION	FİYAT PRICE
VYEX1 410	4 x 10	116,00 ₺
VYEX1 416	4 x 16	116,00 ₺
VYEX1 425	4 x 25	121,00 ₺
VYEX1 31610	3 x 16 + 10	116,00 ₺
VYEX1 32516	3 x 25 + 16	121,00 ₺



0.6-1 kV

KOD CODE	KABLO KESİTİ CROSS SECTION	FİYAT PRICE
VYE1 435	4 x 35	195,00 ₺
VYE1 450	4 x 50	195,00 ₺
VYE1 470	4 x 70	198,00 ₺
VYE1 33516	3 x 35 + 16	195,00 ₺
VYE1 35025	3 x 50 + 25	195,00 ₺
VYE1 37035	3 x 70 + 35	198,00 ₺



0.6-1 kV

KOD CODE	KABLO KESİTİ CROSS SECTION	FİYAT PRICE
VYEX1 435	4 x 35	177,00 ₺
VYEX1 450	4 x 50	177,00 ₺
VYEX1 470	4 x 70	182,00 ₺
VYEX1 33516	3 x 35 + 16	177,00 ₺
VYEX1 35025	3 x 50 + 25	177,00 ₺
VYEX1 37035	3 x 70 + 35	182,00 ₺

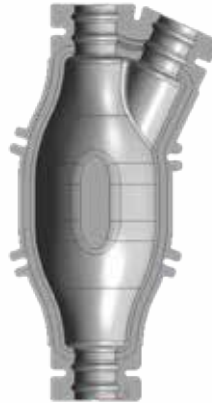

0.6-1 kV

KOD CODE	KABLO KESİTİ CROSS SECTION	FİYAT PRICE
VYE1 495	4 x 95	277,00 ₺
VYE1 4120	4 x 120	283,00 ₺
VYE1 39550	3 x 95 + 50	277,00 ₺
VYE1 31207	3 x 120 + 70	283,00 ₺



0.6-1 kV

KOD CODE	KABLO KESİTİ CROSS SECTION	FİYAT PRICE
VYEX1 495	4 x 95	253,00 ₺
VYEX1 4120	4 x 120	258,00 ₺
VYEX1 39550	3 x 95 + 50	253,00 ₺
VYEX1 31207	3 x 120 + 70	258,00 ₺



0.6-1 kV

KOD CODE	KABLO KESİTİ CROSS SECTION	FİYAT PRICE
VYE1 4150	4 x 150	479,00 ₺
VYE1 4185	4 x 185	479,00 ₺
VYE1 4240	4 x 240	484,00 ₺
VYE1 31507	3 x 150 + 70	479,00 ₺
VYE1 31859	3 x 185 + 95	479,00 ₺
VYE1 32401	3 x 240 + 120	484,00 ₺



0.6-1 kV

KOD CODE	KABLO KESİTİ CROSS SECTION	FİYAT PRICE
VYEX1 4150	4 x 150	435,00 ₺
VYEX1 4185	4 x 185	435,00 ₺
VYEX1 4240	4 x 240	439,00 ₺
VYEX1 31507	3 x 150 + 70	435,00 ₺
VYEX1 31859	3 x 185 + 95	435,00 ₺
VYEX1 32401	3 x 240 + 120	439,00 ₺



3.5-6 kV



5.8-10 kV

KOD CODE	KABLO KESİTİ CROSS SECTION	FIYAT PRICE
E6 125	1 x 25 + 16	225,00 ₺
E6 135	1 x 35 + 16	225,00 ₺
E6 150	1 x 50 + 16	225,00 ₺
E6 170	1 x 70 + 16	225,00 ₺
E6 195	1 x 95 + 16	225,00 ₺
E6 1120	1 x 120 + 16	237,00 ₺
E6 1150	1 x 150 + 25	237,00 ₺
E6 1185	1 x 185 + 25	241,00 ₺
E6 1240	1 x 240 + 25	241,00 ₺
E6 1300	1 x 300 + 25	262,00 ₺

KOD CODE	KABLO KESİTİ CROSS SECTION	FIYAT PRICE
E10 125	1 x 25 + 16	225,00 ₺
E10 135	1 x 35 + 16	225,00 ₺
E10 150	1 x 50 + 16	225,00 ₺
E10 170	1 x 70 + 16	225,00 ₺
E10 195	1 x 95 + 16	225,00 ₺
E10 1120	1 x 120 + 16	237,00 ₺
E10 1150	1 x 150 + 25	237,00 ₺
E10 1185	1 x 185 + 25	241,00 ₺
E10 1240	1 x 240 + 25	241,00 ₺
E10 1300	1 x 300 + 25	262,00 ₺

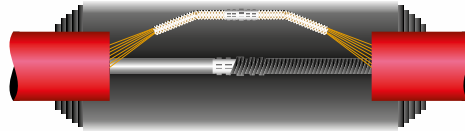

8.7-15 kV



20.8-36 kV

KOD CODE	KABLO KESİTİ CROSS SECTION	FIYAT PRICE
E15 125	1 x 25 + 16	225,00 ₺
E15 135	1 x 35 + 16	225,00 ₺
E15 150	1 x 50 + 16	225,00 ₺
E15 170	1 x 70 + 16	225,00 ₺
E15 195	1 x 95 + 16	225,00 ₺
E15 1120	1 x 120 + 16	237,00 ₺
E15 1150	1 x 150 + 25	237,00 ₺
E15 1185	1 x 185 + 25	241,00 ₺
E15 1240	1 x 240 + 25	241,00 ₺
E15 1300	1 x 300 + 25	262,00 ₺

KOD CODE	KABLO KESİTİ CROSS SECTION	FIYAT PRICE
E36 125	1 x 25 + 16	385,00 ₺
E36 135	1 x 35 + 16	385,00 ₺
E36 150	1 x 50 + 16	385,00 ₺
E36 170	1 x 70 + 16	385,00 ₺
E36 195	1 x 95 + 16	385,00 ₺
E36 1120	1 x 120 + 16	400,00 ₺
E36 1150	1 x 150 + 25	400,00 ₺
E36 1185	1 x 185 + 25	407,00 ₺
E36 1240	1 x 240 + 25	407,00 ₺
E36 1300	1 x 300 + 25	407,00 ₺

# O.G. ÜÇ DAMARLI REÇİNELİ KABLO EK MUFLARI

M.V. THREE CORES RESIN CABLE JOINTS



3.5-6 kV



5.8-10 kV

KOD CODE	KABLO KESİTİ CROSS SECTION	FİYAT PRICE
E6 325	3 x 25 + 16	787,00 ₺
E6 335	3 x 35 + 16	787,00 ₺
E6 350	3 x 50 + 16	787,00 ₺
E6 370	3 x 70 + 16	825,00 ₺
E6 395	3 x 95 + 16	825,00 ₺
E6 3120	3 x 120 + 16	840,00 ₺
E6 3150	3 x 150 + 25	840,00 ₺
E6 3185	3 x 185 + 25	850,00 ₺
E6 3240	3 x 240 + 25	850,00 ₺
E6 3300	3 x 300 + 25	865,00 ₺

KOD CODE	KABLO KESİTİ CROSS SECTION	FİYAT PRICE
E10 325	3 x 25 + 16	787,00 ₺
E10 335	3 x 35 + 16	787,00 ₺
E10 350	3 x 50 + 16	787,00 ₺
E10 370	3 x 70 + 16	825,00 ₺
E10 395	3 x 95 + 16	825,00 ₺
E10 3120	3 x 120 + 16	840,00 ₺
E10 3150	3 x 150 + 25	840,00 ₺
E10 3185	3 x 185 + 25	850,00 ₺
E10 3240	3 x 240 + 25	850,00 ₺
E10 3300	3 x 300 + 25	865,00 ₺

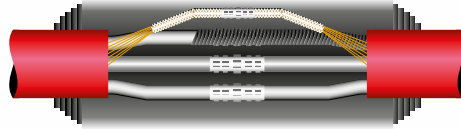

8.7-15 kV



20.8-36 kV

KOD CODE	KABLO KESİTİ CROSS SECTION	FİYAT PRICE
E15 325	3 x 25 + 16	787,00 ₺
E15 335	3 x 35 + 16	787,00 ₺
E15 350	3 x 50 + 16	787,00 ₺
E15 370	3 x 70 + 16	825,00 ₺
E15 395	3 x 95 + 16	825,00 ₺
E15 3120	3 x 120 + 16	840,00 ₺
E15 3150	3 x 150 + 25	840,00 ₺
E15 3185	3 x 185 + 25	850,00 ₺
E15 3240	3 x 240 + 25	850,00 ₺
E15 3300	3 x 300 + 25	865,00 ₺

KOD CODE	KABLO KESİTİ CROSS SECTION	FİYAT PRICE
E36 335	3 x 35 + 16	1.799,00 ₺
E36 350	3 x 50 + 16	1.799,00 ₺
E36 370	3 x 70 + 16	1.810,00 ₺
E36 395	3 x 95 + 16	1.810,00 ₺
E36 3120	3 x 120 + 16	1.815,00 ₺
E36 3150	3 x 150 + 25	1.815,00 ₺
E36 3185	3 x 185 + 25	1.855,00 ₺
E36 3240	3 x 240 + 25	1.855,00 ₺
E36 3300	3 x 300 + 25	1.895,00 ₺



0.6-1 kV

KOD CODE	KABLO KESİTİ CROSS SECTION	FİYAT PRICE
PSİLDE1 410	4 x 10	124,00 ₺
PSİLDE1 416	4 x 16	124,00 ₺
PSİLDE1 425	4 x 25	136,00 ₺
PSİLDE1 31610	3 x 16 + 10	124,00 ₺
PSİLDE1 32516	3 x 25 + 16	136,00 ₺



0.6-1 kV

KOD CODE	KABLO KESİTİ CROSS SECTION	FİYAT PRICE
PSİLDEX1 410	4 x 10	103,00 ₺
PSİLDEX1 416	4 x 16	103,00 ₺
PSİLDEX1 425	4 x 25	103,00 ₺
PSİLDEX1 31610	3 x 16 + 10	103,00 ₺
PSİLDEX1 32516	3 x 25 + 16	103,00 ₺



0.6-1 kV

KOD CODE	KABLO KESİTİ CROSS SECTION	FİYAT PRICE
PSİLDE1 435	4 x 35	199,00 ₺
PSİLDE1 450	4 x 50	199,00 ₺
PSİLDE1 470	4 x 70	199,00 ₺
PSİLDE1 33516	3 x 35 + 16	198,00 ₺
PSİLDE1 35025	3 x 50 + 25	198,00 ₺
PSİLDE1 37035	3 x 70 + 35	198,00 ₺

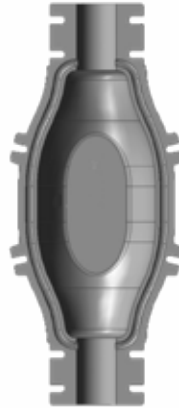

0.6-1 kV

KOD CODE	KABLO KESİTİ CROSS SECTION	FİYAT PRICE
PSİLDEX1 435	4 x 35	166,00 ₺
PSİLDEX1 450	4 x 50	166,00 ₺
PSİLDEX1 470	4 x 70	166,00 ₺
PSİLDEX1 33516	3 x 35 + 16	166,00 ₺
PSİLDEX1 35025	3 x 50 + 25	166,00 ₺
PSİLDEX1 37035	3 x 70 + 35	166,00 ₺



0.6-1 kV

KOD CODE	KABLO KESİTİ CROSS SECTION	FİYAT PRICE
PSİLDE1 495	4 x 95	243,00 ₺
PSİLDE1 4120	4 x 120	257,00 ₺
PSİLDE1 4150	4 x 150	305,00 ₺
PSİLDE1 4185	4 x 185	342,00 ₺
PSİLDE1 4240	4 x 240	363,00 ₺
PSİLDE1 39550	3 x 95 + 50	242,00 ₺
PSİLDE1 31207	3 x 120 + 70	256,00 ₺
PSİLDE1 31507	3 x 150 + 70	304,00 ₺
PSİLDE1 31859	3 x 185 + 95	341,00 ₺
PSİLDE1 32401	3 x 240 + 120	362,00 ₺



0.6-1 kV

KOD CODE	KABLO KESİTİ CROSS SECTION	FİYAT PRICE
PSİLDEX1 495	4 x 95	196,00 ₺
PSİLDEX1 4120	4 x 120	213,00 ₺
PSİLDEX1 4150	4 x 150	256,00 ₺
PSİLDEX1 4185	4 x 185	278,00 ₺
PSİLDEX1 4240	4 x 240	320,00 ₺
PSİLDEX1 39550	3 x 95 + 50	196,00 ₺
PSİLDEX1 31207	3 x 120 + 70	213,00 ₺
PSİLDEX1 31507	3 x 150 + 70	256,00 ₺
PSİLDEX1 31859	3 x 185 + 95	278,00 ₺
PSİLDEX1 32401	3 x 240 + 120	320,00 ₺

# YENİLENEBİLİR Y BRANŞMAN VIDALI ŞEFFAF KABLO EK MUFLARI

RENEWABLE Y TYPE SCREW TRANSPARENT CABLE JOINTS



0.6-1 kV

KOD CODE	KABLO KESİTİ CROSS SECTION	FİYAT PRICE
PSİLYE1 410	4 x 10	180,00 ₺
PSİLYE1 416	4 x 16	180,00 ₺
PSİLYE1 425	4 x 25	190,00 ₺
PSİLYE1 31610	3 x 16 + 10	180,00 ₺
PSİLYE1 32516	3 x 25 + 16	190,00 ₺



0.6-1 kV

KOD CODE	KABLO KESİTİ CROSS SECTION	FİYAT PRICE
PSİLYEX1 410	4 x 10	148,00 ₺
PSİLYEX1 416	4 x 16	148,00 ₺
PSİLYEX1 425	4 x 25	148,00 ₺
PSİLYEX1 31610	3 x 16 + 10	148,00 ₺
PSİLYEX1 32516	3 x 25 + 16	148,00 ₺



0.6-1 kV

KOD CODE	KABLO KESİTİ CROSS SECTION	FİYAT PRICE
PSİLYE1 435	4 x 35	268,00 ₺
PSİLYE1 450	4 x 50	268,00 ₺
PSİLYE1 470	4 x 70	270,00 ₺
PSİLYE1 33516	3 x 35 + 16	268,00 ₺
PSİLYE1 35025	3 x 50 + 25	268,00 ₺
PSİLYE1 37035	3 x 70 + 35	270,00 ₺



0.6-1 kV

KOD CODE	KABLO KESİTİ CROSS SECTION	FİYAT PRICE
PSİLYEX1 435	4 x 35	215,00 ₺
PSİLYEX1 450	4 x 50	215,00 ₺
PSİLYEX1 470	4 x 70	215,00 ₺
PSİLYEX1 33516	3 x 35 + 16	215,00 ₺
PSİLYEX1 35025	3 x 50 + 25	215,00 ₺
PSİLYEX1 37035	3 x 70 + 35	215,00 ₺

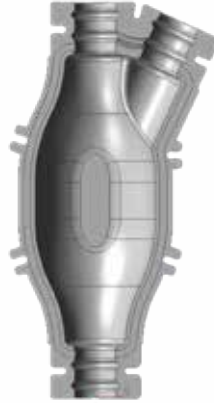

0.6-1 kV

KOD CODE	KABLO KESİTİ CROSS SECTION	FİYAT PRICE
PSİLYE1 495	4 x 95	367,00 ₺
PSİLYE1 4120	4 x 120	370,00 ₺
PSİLYE1 39550	3 x 95 + 50	367,00 ₺
PSİLYE1 31207	3 x 120 + 70	370,00 ₺

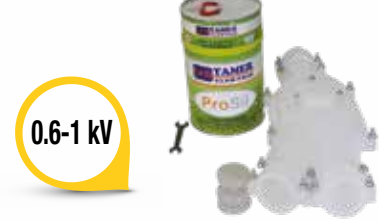

0.6-1 kV

KOD CODE	KABLO KESİTİ CROSS SECTION	FİYAT PRICE
PSİLYEX1 495	4 x 95	300,00 ₺
PSİLYEX1 4120	4 x 120	300,00 ₺
PSİLYEX1 39550	3 x 95 + 50	300,00 ₺
PSİLYEX1 31207	3 x 120 + 70	300,00 ₺



0.6-1 kV

KOD CODE	KABLO KESİTİ CROSS SECTION	FİYAT PRICE
PSİLYE1 4150	4 x 150	615,00 ₺
PSİLYE1 4185	4 x 185	615,00 ₺
PSİLYE1 4240	4 x 240	615,00 ₺
PSİLYE1 31507	3 x 150 + 70	618,00 ₺
PSİLYE1 31859	3 x 185 + 95	618,00 ₺
PSİLYE1 32401	3 x 240 + 120	618,00 ₺



0.6-1 kV

KOD CODE	KABLO KESİTİ CROSS SECTION	FİYAT PRICE
PSİLYEX1 4150	4 x 150	514,00 ₺
PSİLYEX1 4185	4 x 185	514,00 ₺
PSİLYEX1 4240	4 x 240	514,00 ₺
PSİLYEX1 31507	3 x 150 + 70	514,00 ₺
PSİLYEX1 31859	3 x 185 + 95	514,00 ₺
PSİLYEX1 32401	3 x 240 + 120	514,00 ₺



KOD CODE	KABLO KESİTİ CROSS SECTION	FİYAT PRICE
PSİLTE1 4120	4 x 120	326,00 ₺
PSİLTE1 4150	4 x 150	328,00 ₺
PSİLTE1 4185	4 x 185	330,00 ₺
PSİLTE1 4240	4 x 240	332,00 ₺
PSİLTE1 31207	3 x 120 + 70	323,00 ₺
PSİLTE1 31507	3 x 150 + 70	325,00 ₺
PSİLTE1 31859	3 x 185 + 95	327,00 ₺
PSİLTE1 32401	3 x 240 + 120	329,00 ₺



## YENİLENEBİLİR ESNEK DOLGULU REÇİNELER

### RENEWABLE FLEXIBLE RESINS FILLED



1 kg

KOD CODE	AĞIRLIK WEIGHT	ADET/KOLİ UNIT/BOX	FİYAT PRICE
PSİL 1000	1000 gr.	24	46,00 ₺



4 kg

KOD CODE	AĞIRLIK WEIGHT	ADET/KOLİ UNIT/BOX	FİYAT PRICE
PSİL 4000	4000 gr.	6	150,00 ₺

20 kg



KOD CODE	AĞIRLIK WEIGHT	ADET/KOLİ UNIT/BOX	FİYAT PRICE
PSİL 20.000	20 kg.	1	740,00 ₺

# PROTOLİNLER / REÇİNELER

PROTOLINS / RESINS



210 GR

KOD CODE	AĞIRLIK WEIGHT	ADET/KOLİ UNIT/BOX	FİYAT PRICE
PRO 210	210 gr.	100	13,00 ₺



300 GR

KOD CODE	AĞIRLIK WEIGHT	ADET/KOLİ UNIT/BOX	FİYAT PRICE
PRO 300	300 gr.	50	15,00 ₺



500 GR

KOD CODE	AĞIRLIK WEIGHT	ADET/KOLİ UNIT/BOX	FİYAT PRICE
PRO 500	500 gr.	45	21,50 ₺



600 GR

KOD CODE	AĞIRLIK WEIGHT	ADET/KOLİ UNIT/BOX	FİYAT PRICE
PRO 600	600 gr.	45	26,70 ₺



1 KG

KOD CODE	AĞIRLIK WEIGHT	ADET/KOLİ UNIT/BOX	FİYAT PRICE
PRO 1000	1000 gr.	24	38,45 ₺

1.5 KG



KOD CODE	AĞIRLIK WEIGHT	ADET/KOLİ UNIT/BOX	FİYAT PRICE
PRO 1500	1500 gr.	16	57,90 ₺

2 KG



KOD CODE	AĞIRLIK WEIGHT	ADET/KOLİ UNIT/BOX	FİYAT PRICE
PRO 2000	2000 gr.	16	75,00 ₺

3 KG



KOD CODE	AĞIRLIK WEIGHT	ADET/KOLİ UNIT/BOX	FİYAT PRICE
PRO 3000	3000 gr.	6	114,50 ₺

4 KG



KOD CODE	AĞIRLIK WEIGHT	ADET/KOLİ UNIT/BOX	FİYAT PRICE
PRO 4000	4000 gr.	6	134,50 ₺

20 KG



KOD CODE	AĞIRLIK WEIGHT	ADET/KOLİ UNIT/BOX	FİYAT PRICE
PRO 20000	20 kg.	1	655,00 ₺



AG & OG  
İzolasyon  
Kapamalarında  
Ortak Çözüm...



***tamflex***<sup>®</sup>



tamflex bir **TAMER Elektrik** Markasıdır.



# AG & OG İZOLASYON KAPAMALARI

LV & MV INSULATION COVERING

0.6-1 kV

## AG BUŞIĞI KAPAMALAR

LV BUSHING COVERING

KOD CODE	UYGUN TRAFİKO SUITABLE TRANSF.	Akım-Amper (A) CURRENT (A)	ADET/UNIT	FİYAT PRICE
TBK-01	1000-1600kVA	2000-3150A	1	100,00 ₺
TBK-05	500-800kVA	1000-1250A	1	90,00 ₺
TBK-04	200-400kVA	630A	1	80,00 ₺
TBK-06	50-160kVA	250A	1	75,00 ₺



## OG BUŞIĞI KAPAMA

MV BUSHING COVERING

20.8-36 kV

KOD CODE	UYGUN TRAFİKO SUITABLE TRANSF.	Akım-Amper (A) CURRENT (A)	ADET/UNIT	FİYAT PRICE
TBK-02	36kV, 10-1600kVA	250-3150A	1	120,00 ₺

20.8-36 kV

## OG VHD İZOLATÖR KAPAMA

MV VHD INSULATOR COVERING

KOD CODE	UYGUN İZOLATÖR SUITABLE INSULATOR	ADET/UNIT	FİYAT PRICE
TBK-03 (Borulu)	36kV, VHD-35 SII	1	170,00 ₺
TBK-03 (Borusuz)	36kV, VHD-35 SII	1	130,00 ₺



20.8-36 kV

## OG PARAFUDR KAPAMA

MV PARAFUDR COVERING



KOD CODE	UYGUN TRAFİKO SUITABLE TRANSF.	Akım-Amper (A) CURRENT (A)	ADET/UNIT	(a) DARALMA ÖNCESİ BEFORE EXPANDED (mm) Ø	(b) DARALMA SONRASI AFTER EXPANDED (mm) Ø	(L) UZUNLUK LENGTH (m)	FİYAT PRICE (m/₺)
TPK-01	36kV, 10-1600kVA	250-3150A	1	-	-	-	50,00 ₺
TAIB 21/7 (Q8 İzolasyon Borusu)				21	7	1,15 veya (25m/rolu)	53,80 ₺

## OG HAVAI HAT KAPAMA

MV OVERHEAD-LINE PROTECTION

20.8-36 kV

KOD CODE	İLETKEN TİPİ CONDUCTOR TYPE	MAKSİMUM İLETKEN ÇAPİ MAX CONDUCTOR SIZE	METRE/METER	FİYAT PRICE
THK-01	Swallow (3)	70 mm	1	55,00 ₺
	Raven(1/0)			
	Piegon (3/0)			
	Sparrow (2)			





0.6-1 kV

KOD CODE	KABLO KESİTİ CROSS SECTION	FİYAT PRICE
S1 4105	4 x 1,5	18,50 ₺
S1 4205	4 x 2,5	18,50 ₺
S1 404	4 x 4	18,50 ₺
S1 406	4 x 6	18,50 ₺
S1 410	4 x 10	23,10 ₺
S1 416	4 x 16	24,45 ₺
S1 425	4 x 25	37,75 ₺
S1 435	4 x 35	40,60 ₺
S1 450	4 x 50	43,90 ₺
S1 470	4 x 70	65,10 ₺
S1 495	4 x 95	71,50 ₺
S1 4120	4 x 120	93,45 ₺
S1 4150	4 x 150	99,00 ₺
S1 4185	4 x 185	185,70 ₺
S1 4240	4 x 240	194,10 ₺
S1 4300	4 x 300	212,15 ₺
S1 4400	4 x 400	239,80 ₺
S1 31610	3 x 16 + 10	24,45 ₺
S1 32516	3 x 25 + 16	36,50 ₺
S1 33516	3 x 35 + 16	39,60 ₺
S1 35025	3 x 50 + 25	42,70 ₺
S1 37035	3 x 70 + 35	63,95 ₺
S1 39550	3 x 95 + 50	69,80 ₺
S1 31207	3 x 120 + 70	91,15 ₺
S1 31507	3 x 150 + 70	112,40 ₺
S1 31859	3 x 185 + 95	183,35 ₺
S1 32401	3 x 240 + 120	191,85 ₺
S1 33001	3 x 300 + 150	207,35 ₺
S1 34001	3 x 400 + 185	235,25 ₺



0.6-1 kV

KOD CODE	KABLO KESİTİ CROSS SECTION	FİYAT PRICE
S1 115 - S1 104	1 x 1,5 - 1 x 4	12,20 ₺
S1 106 - S1 110	1 x 6 - 1 x 10	12,20 ₺
S1 116 - S1 125	1 x 16 - 1 x 25	13,80 ₺
S1 135 - S1 150	1 x 35 - 1 x 50	18,35 ₺
S1 170 - S1 195	1 x 70 - 1 x 95	25,30 ₺
S1 1120 - S1 1150	1 x 120 - 1 x 150	30,45 ₺
S1 1185 - S1 1240	1 x 185 - 1 x 240	36,50 ₺
S1 1300 - S1 1400	1 x 300 - 1 x 400	45,95 ₺



0.6-1 kV

KOD CODE	KABLO KESİTİ CROSS SECTION	FİYAT PRICE
S1 315	3 x 1,5	17,15 ₺
S1 304	3 x 4	17,15 ₺
S1 306	3 x 6	17,15 ₺
S1 310	3 x 10	21,95 ₺
S1 316	3 x 16	23,10 ₺
S1 325	3 x 25	35,45 ₺
S1 335	3 x 35	38,40 ₺
S1 350	3 x 50	41,65 ₺
S1 370	3 x 70	62,90 ₺
S1 395	3 x 95	69,20 ₺
S1 3120	3 x 120	87,65 ₺
S1 3150	3 x 150	103,30 ₺
S1 3185	3 x 185	179,80 ₺
S1 3240	3 x 240	188,50 ₺
S1 3300	3 x 300	203,00 ₺
S1 3400	3 x 400	230,55 ₺

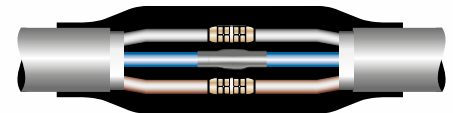

0.6-1 kV

KOD CODE	KABLO KESİTİ CROSS SECTION	FİYAT PRICE
S1 215 - S1 204	2 x 1,5-2 x 4	15,25 ₺
S1 206 - S1 210	2 x 6 - 2 x 10	15,25 ₺
S1 216 - S1 225	2 x 16 - 2 x 25	15,25 ₺
S1 235 - S1 250	2 x 35 - 2 x 50	36,80 ₺
S1 270 - S1 295	2 x 70 - 2 x 95	60,00 ₺
S1 2120 - S1 2150	2 x 120 - 2 x 150	76,10 ₺
S1 2185	2 x 185v	91,40 ₺
S1 2240	2 x 240	94,95 ₺
S1 2300	2 x 300	99,15 ₺
S1 2400	2 x 400	115,10 ₺

\* İstenilen kablo kesitlerine göre ek yapılır. / \* Produce joint according to demand

# ISI BÜZÜŞMELİ KABLO EK MUFLARI

HEAT SHRINKABLE CABLE JOINTS

0.6-1 kV

BAKIR İLETKENLER İÇİN  
FOR COPPER CONNECTORS



0.6-1 kV

ALÜMİNYUM İLETKENLER İÇİN  
FOR ALUMINUM CONNECTORS



KOD CODE	KABLO KESİTİ CROSS SECTION	FİYAT PRICE
S1 5105 - S1 5205	5 x 1,5 - 5 x 2,5	20,25 ₺
S1 504 - S1 506	5 x 4 - 5 x 6	20,25 ₺
S1 510 - S1 516	5 x 10 - 5 x 16	26,50 ₺
S1 525	5 x 25	45,00 ₺
S1 535	5 x 35	62,00 ₺
S1 550	5 x 50	68,00 ₺
S1 570	5 x 70	75,00 ₺
S1 595	5 x 95	81,00 ₺
S1 5120	5 x 120	120,00 ₺
S1 5150	5 x 150	128,00 ₺
S1 5185	5 x 185	202,00 ₺
S1 5240	5 x 240	215,00 ₺
S1 7105 - S1 7205	7 x 1,5 - 7 x 2,5	22,00 ₺
S1 10105 - S1 10205	10 x 1,5 - 10 x 2,5	32,50 ₺
S1 12105 - S1 12205	12 x 1,5 - 12 x 2,5	42,45 ₺

KOD CODE	KABLO KESİTİ CROSS SECTION	FİYAT PRICE
AS1 510 - S1 516	5 x 10 - 5 x 16	25,50 ₺
AS1 525	5 x 25	44,00 ₺
AS1 535	5 x 35	60,00 ₺
AS1 550	5 x 50	65,00 ₺
AS1 570	5 x 70	72,00 ₺
AS1 595	5 x 95	78,00 ₺
AS1 5120	5 x 120	117,00 ₺
AS1 5150	5 x 150	125,00 ₺
AS1 5185	5 x 185	199,00 ₺
AS1 5240	5 x 240	210,00 ₺

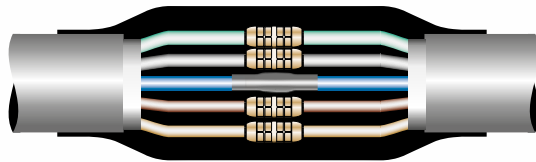

0.6-1 kV



KOD CODE	KABLO KESİTİ CROSS SECTION	FİYAT PRICE
AS1 425	4 x 25	36,00 ₺
AS1 435	4 x 35	39,60 ₺
AS1 450	4 x 50	42,70 ₺
AS1 470	4 x 70	63,95 ₺
AS1 495	4 x 95	70,00 ₺
AS1 4120	4 x 120	92,15 ₺
AS1 4150	4 x 150	97,50 ₺
AS1 4185	4 x 185	184,30 ₺
AS1 4240	4 x 240	193,50 ₺
AS1 4300	4 x 300	209,75 ₺
AS1 4400	4 x 400	237,55 ₺
AS1 32516	3 x 25 + 16	35,45 ₺
AS1 33516	3 x 35 + 16	38,40 ₺
AS1 35025	3 x 50 + 25	41,65 ₺
AS1 37035	3 x 70 + 35	62,90 ₺
AS1 39550	3 x 95 + 50	68,80 ₺
AS1 31207	3 x 120 + 70	89,90 ₺
AS1 31507	3 x 150 + 70	106,60 ₺
AS1 31859	3 x 185 + 95	179,80 ₺
AS1 32401	3 x 240 + 120	189,00 ₺
AS1 33001	3 x 300 + 150	205,20 ₺
AS1 34001	3 x 400 + 185	232,80 ₺

0.6-1 kV



KOD CODE	KABLO KESİTİ CROSS SECTION	FİYAT PRICE
AS1 325	3 x 25	34,25 ₺
AS1 335	3 x 35	37,20 ₺
AS1 350	3 x 50	40,35 ₺
AS1 370	3 x 70	61,70 ₺
AS1 395	3 x 95	68,10 ₺
AS1 3120	3 x 120	86,45 ₺
AS1 3150	3 x 150	100,85 ₺
AS1 3185	3 x 185	177,50 ₺
AS1 3240	3 x 240	184,30 ₺
AS1 3300	3 x 300	200,00 ₺
AS1 3400	3 x 400	225,00 ₺

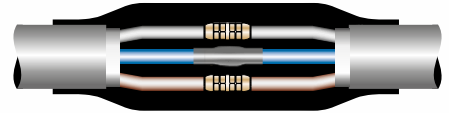

0.6-1 kV



0.6-1 kV



KOD CODE	KABLO KESİTİ CROSS SECTION	FİYAT PRICE
AS1 125	1 x 25	12,70 ₺
AS1 135 - AS1 150	1 x 35 - 1 x 50	17,15 ₺
AS1 170 - AS1 195	1 x 70 - 1 x 95	24,15 ₺
AS1 1120 - AS1 1150	1 x 120 - 1 x 150	28,20 ₺
AS1 1185 - AS1 1240	1 x 185 - 1 x 240	34,25 ₺
AS1 1300 - AS1 1400	1 x 300 - 1 x 400	44,35 ₺

KOD CODE	KABLO KESİTİ CROSS SECTION	FİYAT PRICE
AS1 225	2 x 25	14,25 ₺
AS1 235 - AS1 250	2 x 35 - 2 x 50	35,75 ₺
AS1 270 - AS1 295	2 x 70 - 2 x 95	58,80 ₺
AS1 2120 - AS1 2150	2 x 120 - 2 x 150	73,80 ₺
AS1 2185	2 x 185	88,70 ₺
AS1 2240	2 x 240	92,20 ₺
AS1 2300	2 x 300	96,85 ₺
AS1 2400	2 x 400	112,95 ₺

\* İstenilen kablo kesitlerine göre ek yapılır. / \* Produce joint according to demand

# FERMUARLI ISI BÜZÜŞMELİ KABLO EK MUFLARI

REPAIR SLEEVE HEAT SHRINKABLE CABLE JOINTS

0.6-1 kV

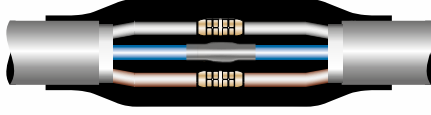

KOD CODE	KABLO KESİTİ CROSS SECTION	FİYAT PRICE
FS1 - 31610	3 x 16 + 10	80,00 ₺
FS1 - 32516	3 x 25 + 16	83,85 ₺
FS1 - 33516	3 x 35 + 16	85,00 ₺
FS1 - 35025	3 x 50 + 25	87,55 ₺
FS1 - 37035	3 x 70 + 35	111,55 ₺
FS1 - 39550	3 x 95 + 50	115,00 ₺
FS1 - 31207	3 x 120 + 70	137,55 ₺
FS1 - 31507	3 x 150 + 70	142,55 ₺
FS1 - 31859	3 x 185 + 95	170,00 ₺
FS1 - 32401	3 x 240 + 120	187,65 ₺
FS1 - 33001	3 x 300 + 150	225,00 ₺
FS1 - 34001	3 x 400 + 185	250,00 ₺
FS1 - 4105	4 x 1,5	70,00 ₺
FS1 - 4205	4 x 2,5	70,00 ₺
FS1 - 404	4 x 4	70,00 ₺
FS1 - 406	4 x 6	70,00 ₺
FS1 - 410	4 x 10	75,55 ₺
FS1 - 416	4 x 16	80,00 ₺
FS1 - 425	4 x 25	85,00 ₺
FS1 - 435	4 x 35	86,50 ₺
FS1 - 450	4 x 50	88,90 ₺
FS1 - 470	4 x 70	113,90 ₺
FS1 - 495	4 x 95	117,60 ₺
FS1 - 4120	4 x 120	140,00 ₺
FS1 - 4150	4 x 150	145,00 ₺
FS1 - 4185	4 x 185	173,00 ₺
FS1 - 4240	4 x 240	190,00 ₺
FS1 - 4300	4 x 300	229,50 ₺
FS1 - 4400	4 x 400	255,00 ₺
FS1 5105 - FS1 5205	5 x 1,5-5 x 2,5	75,00 ₺
FS1 504 - FS1 506	5 x 4-5 x 6	75,00 ₺
FS1 510	5 x 10	80,00 ₺
FS1 516	5 x 16	86,00 ₺
FS1 525	5 x 25	91,00 ₺
FS1 535	5 x 35	95,00 ₺
FS1 550	5 x 50	112,00 ₺
FS1 570	5 x 70	122,00 ₺
FS1 595	5 x 95	144,00 ₺
FS1 5120	5 x 120	159,00 ₺
FS1 5150	5 x 150	166,00 ₺
FS1 5185	5 x 185	215,00 ₺
FS1 5240	5 x 240	236,00 ₺

0.6-1 kV

BAKIR İLETKENLER İÇİN  
FOR COPPER CONNECTORS



KOD CODE	KABLO KESİTİ CROSS SECTION	FİYAT PRICE
ZS1 - 4105	4 x 1,5	33,50 ₺
ZS1 - 4205	4 x 2,5	33,50 ₺
ZS1 - 404	4 x 4	33,50 ₺
ZS1 - 406	4 x 6	33,50 ₺
ZS1 - 410	4 x 10	38,35 ₺
ZS1 - 416	4 x 16	39,55 ₺
ZS1 - 425	4 x 25	53,80 ₺
ZS1 - 435	4 x 35	62,20 ₺
ZS1 - 450	4 x 50	64,60 ₺
ZS1 - 470	4 x 70	86,60 ₺
ZS1 - 495	4 x 95	98,15 ₺
ZS1 - 4120	4 x 120	122,00 ₺
ZS1 - 4150	4 x 150	136,35 ₺
ZS1 - 4185	4 x 185	240,50 ₺
ZS1 - 4240	4 x 240	273,50 ₺
ZS1 - 4300	4 x 300	291,95 ₺
ZS1 - 4400	4 x 400	318,15 ₺
ZS1 - 31610	3 x 16 + 10	38,35 ₺
ZS1 - 32516	3 x 25 + 16	52,65 ₺
ZS1 - 33516	3 x 35 + 16	61,00 ₺
ZS1 - 35025	3 x 50 + 25	63,35 ₺
ZS1 - 37035	3 x 70 + 35	85,60 ₺
ZS1 - 39550	3 x 95 + 50	95,70 ₺
ZS1 - 31207	3 x 120 + 70	119,60 ₺
ZS1 - 31507	3 x 150 + 70	134,00 ₺
ZS1 - 31859	3 x 185 + 95	214,00 ₺
ZS1 - 32401	3 x 240 + 120	235,70 ₺
ZS1 - 33001	3 x 300 + 150	287,00 ₺
ZS1 - 34001	3 x 400 + 185	311,00 ₺

0.6-1 kV

ALÜMİNYUM İLETKENLER İÇİN  
FOR ALUMINUM CONNECTORS



KOD CODE	KABLO KESİTİ CROSS SECTION	FİYAT PRICE
AZS1 - 425	4 x 25	52,65 ₺
AZS1 - 435	4 x 35	61,00 ₺
AZS1 - 450	4 x 50	63,35 ₺
AZS1 - 470	4 x 70	85,60 ₺
AZS1 - 495	4 x 95	96,95 ₺
AZS1 - 4120	4 x 120	120,85 ₺
AZS1 - 4150	4 x 150	135,20 ₺
AZS1 - 4185	4 x 185	215,25 ₺
AZS1 - 4240	4 x 240	239,20 ₺
AZS1 - 4300	4 x 300	287,45 ₺
AZS1 - 4400	4 x 400	311,00 ₺
AZS1 - 32516	3 x 25 + 16	51,50 ₺
AZS1 - 33516	3 x 35 + 16	59,85 ₺
AZS1 - 35025	3 x 50 + 25	62,20 ₺
AZS1 - 37035	3 x 70 + 35	84,20 ₺
AZS1 - 39550	3 x 95 + 50	94,60 ₺
AZS1 - 31207	3 x 120 + 70	118,40 ₺
AZS1 - 31507	3 x 150 + 70	132,75 ₺
AZS1 - 31859	3 x 185 + 95	213,00 ₺
AZS1 - 32401	3 x 240 + 120	234,50 ₺
AZS1 - 33001	3 x 300 + 150	282,35 ₺
AZS1 - 34001	3 x 400 + 185	305,00 ₺

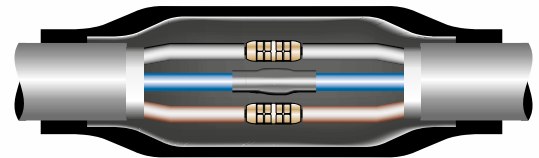

**AG-OG**  
**Kablo Ek Mufu**  
**Yalıtımında**  
**Üst Düzey**  
**Koruma**





3.5-6 kV

KOD CODE	KABLO KESİTİ CROSS SECTION	KOLİ ADETİ UNIT / BOX	FİYAT PRICE
IB6 125	1 x 25 + 16	20	272,85 ₺
IB6 135	1 x 35 + 16	20	272,85 ₺
IB6 150	1 x 50 + 16	20	272,85 ₺
IB6 170	1 x 70 + 16	20	274,80 ₺
IB6 195	1 x 95 + 16	20	274,80 ₺
IB6 1120	1 x 120 + 16	20	276,85 ₺
IB6 1150	1 x 150 + 25	20	276,85 ₺
IB6 1185	1 x 185 + 25	20	280,80 ₺
IB6 1240	1 x 240 + 25	20	286,65 ₺
IB6 1300	1 x 300 + 25	20	296,55 ₺
IB6 1400	1 x 400 + 35	20	314,40 ₺
IB6 1500	1 x 500 + 35	20	316,95 ₺
IB6 1630	1 x 630 + 35	20	398,00 ₺

5.8-10 kV



KOD CODE	KABLO KESİTİ CROSS SECTION	KOLİ ADETİ UNIT / BOX	FİYAT PRICE
IB10 125	1 x 25 + 16	20	272,85 ₺
IB10 135	1 x 35 + 16	20	272,85 ₺
IB10 150	1 x 50 + 16	20	272,85 ₺
IB10 170	1 x 70 + 16	20	274,80 ₺
IB10 195	1 x 95 + 16	20	274,80 ₺
IB10 1120	1 x 120 + 16	20	276,85 ₺
IB10 1150	1 x 150 + 25	20	276,85 ₺
IB10 1185	1 x 185 + 25	20	280,80 ₺
IB10 1240	1 x 240 + 25	20	286,65 ₺
IB10 1300	1 x 300 + 25	20	296,55 ₺
IB15 1400	1 x 400 + 35	20	314,40 ₺
IB15 1500	1 x 500 + 35	20	316,95 ₺
IB15 1630	1 x 630 + 35	20	398,00 ₺



8.7-15 kV

KOD CODE	KABLO KESİTİ CROSS SECTION	KOLİ ADETİ UNIT / BOX	FİYAT PRICE
IB15 125	1 x 25 + 16	20	272,85 ₺
IB15 135	1 x 35 + 16	20	272,85 ₺
IB15 150	1 x 50 + 16	20	272,85 ₺
IB15 170	1 x 70 + 16	20	274,80 ₺
IB15 195	1 x 95 + 16	20	274,80 ₺
IB15 1120	1 x 120 + 16	20	276,85 ₺
IB15 1150	1 x 150 + 25	20	276,85 ₺
IB15 1185	1 x 185 + 25	20	280,80 ₺
IB15 1240	1 x 240 + 25	20	286,65 ₺
IB15 1300	1 x 300 + 25	20	296,55 ₺
IB15 1400	1 x 400 + 35	20	314,40 ₺
IB15 1500	1 x 500 + 35	20	316,95 ₺
IB15 1630	1 x 630 + 35	20	398,00 ₺

20.8-36 kV



KOD CODE	KABLO KESİTİ CROSS SECTION	KOLİ ADETİ UNIT / BOX	FİYAT PRICE
IB36 125	1 x 25 + 16	20	435,00 ₺
IB36 135	1 x 35 + 16	20	435,00 ₺
IB36 150	1 x 50 + 16	20	440,00 ₺
IB36 170	1 x 70 + 16	20	440,00 ₺
IB36 195	1 x 95 + 16	20	440,00 ₺
IB36 1120	1 x 120 + 16	20	445,00 ₺
IB36 1150	1 x 150 + 25	20	445,00 ₺
IB36 1185	1 x 185 + 25	20	450,00 ₺
IB36 1240	1 x 240 + 25	20	450,00 ₺
IB36 1300	1 x 300 + 25	20	490,00 ₺
IB36 1400	1 x 400 + 35	20	512,00 ₺
IB36 1500	1 x 500 + 35	20	559,50 ₺
IB36 1630	1 x 630 + 35	20	615,50 ₺

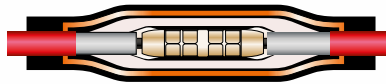



# O.G. ÜÇ DAMARLI ISI BÜZÜŞMELİ KABLO EK MUFLARI

M.V. THREE CORES HEAT SHRINKABLE CABLE JOINTS



3.5-6 kV

KOD CODE	KABLO KESİTİ CROSS SECTION	FİYAT PRICE
IB6 325	3 x 25 + 16	650,00 ₺
IB6 335	3 x 35 + 16	650,00 ₺
IB6 350	3 x 50 + 16	652,40 ₺
IB6 370	3 x 70 + 16	652,40 ₺
IB6 395	3 x 95 + 16	652,40 ₺
IB6 3120	3 x 120 + 16	654,40 ₺
IB6 3150	3 x 150 + 25	654,40 ₺
IB6 3185	3 x 185 + 25	654,40 ₺
IB6 3240	3 x 240 + 25	660,40 ₺
IB6 3300	3 x 300 + 25	686,00 ₺
IB6 3400	3 x 400 + 35	703,80 ₺
IB6 3500	3 x 500 + 35	751,00 ₺

5.8-10 kV



KOD CODE	KABLO KESİTİ CROSS SECTION	FİYAT PRICE
IB10 325	3 x 25 + 16	650,00 ₺
IB10 335	3 x 35 + 16	650,00 ₺
IB10 350	3 x 50 + 16	652,40 ₺
IB10 370	3 x 70 + 16	652,40 ₺
IB10 395	3 x 95 + 16	652,40 ₺
IB10 3120	3 x 120 + 16	654,40 ₺
IB10 3150	3 x 150 + 25	654,40 ₺
IB10 3185	3 x 185 + 25	654,40 ₺
IB10 3240	3 x 240 + 25	660,40 ₺
IB10 3300	3 x 300 + 25	686,00 ₺
IB10 3400	3 x 400 + 35	703,80 ₺
IB10 3500	3 x 500 + 35	751,00 ₺



8.7-15 kV

KOD CODE	KABLO KESİTİ CROSS SECTION	FİYAT PRICE
IB15 325	3 x 25 + 16	650,00 ₺
IB15 335	3 x 35 + 16	650,00 ₺
IB15 350	3 x 50 + 16	652,40 ₺
IB15 370	3 x 70 + 16	652,40 ₺
IB15 395	3 x 95 + 16	652,40 ₺
IB15 3120	3 x 120 + 16	654,40 ₺
IB15 3150	3 x 150 + 25	654,40 ₺
IB15 3185	3 x 185 + 25	654,40 ₺
IB15 3240	3 x 240 + 25	660,40 ₺
IB15 3300	3 x 300 + 25	686,00 ₺
IB15 3400	3 x 400 + 35	703,80 ₺
IB15 3500	3 x 500 + 35	751,00 ₺

20.8-36 kV



KOD CODE	KABLO KESİTİ CROSS SECTION	FİYAT PRICE
IB36 325	3 x 25 + 16	1.702,00 ₺
IB36 335	3 x 35 + 16	1.702,00 ₺
IB36 350	3 x 50 + 16	1.702,00 ₺
IB36 370	3 x 70 + 16	1.704,00 ₺
IB36 395	3 x 95 + 16	1.704,00 ₺
IB36 3120	3 x 120 + 16	1.706,00 ₺
IB36 3150	3 x 150 + 25	1.706,00 ₺
IB36 3185	3 x 185 + 25	1.714,00 ₺
IB36 3240	3 x 240 + 25	1.723,80 ₺
IB36 3300	3 x 300 + 25	1.751,75 ₺
IB36 3400	3 x 400 + 35	1.769,00 ₺
IB36 3500	3 x 500 + 35	1.817,00 ₺

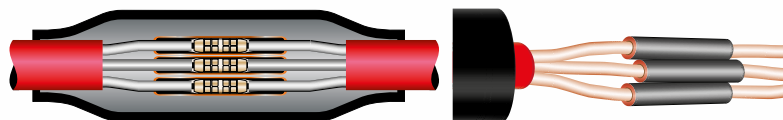



3.5-6 kV

KOD CODE	KABLO KESİTİ CROSS SECTION	KOLİ ADETİ UNIT / BOX	FİYAT PRICE
IBA6 125	1 x 25 + 16	20	271,00 ₺
IBA6 135	1 x 35 + 16	20	271,00 ₺
IBA6 150	1 x 50 + 16	20	271,00 ₺
IBA6 170	1 x 70 + 16	20	273,00 ₺
IBA6 195	1 x 95 + 16	20	273,00 ₺
IBA6 1120	1 x 120 + 16	20	274,00 ₺
IBA6 1150	1 x 150 + 25	20	274,00 ₺
IBA6 1185	1 x 185 + 25	20	279,00 ₺
IBA6 1240	1 x 240 + 25	20	285,00 ₺
IBA6 1300	1 x 300 + 25	20	295,00 ₺
IBA6 1400	1 x 400 + 35	20	312,00 ₺
IBA6 1500	1 x 500 + 35	20	315,00 ₺
IBA6 1630	1 x 630 + 35	20	395,00 ₺

5.8-10 kV



KOD CODE	KABLO KESİTİ CROSS SECTION	KOLİ ADETİ UNIT / BOX	FİYAT PRICE
IBA10 125	1 x 25 + 16	20	271,00 ₺
IBA10 135	1 x 35 + 16	20	271,00 ₺
IBA10 150	1 x 50 + 16	20	271,00 ₺
IBA10 170	1 x 70 + 16	20	273,00 ₺
IBA10 195	1 x 95 + 16	20	273,00 ₺
IBA10 1120	1 x 120 + 16	20	274,00 ₺
IBA10 1150	1 x 150 + 25	20	274,00 ₺
IBA10 1185	1 x 185 + 25	20	279,00 ₺
IBA10 1240	1 x 240 + 25	20	285,00 ₺
IBA10 1300	1 x 300 + 25	20	295,00 ₺
IBA10 1400	1 x 400 + 35	20	312,00 ₺
IBA10 1500	1 x 500 + 35	20	315,00 ₺
IBA10 1630	1 x 630 + 35	20	395,00 ₺



8.7-15 kV

KOD CODE	KABLO KESİTİ CROSS SECTION	KOLİ ADETİ UNIT / BOX	FİYAT PRICE
IBA15 125	1 x 25 + 16	20	271,00 ₺
IBA15 135	1 x 35 + 16	20	271,00 ₺
IBA15 150	1 x 50 + 16	20	271,00 ₺
IBA15 170	1 x 70 + 16	20	273,00 ₺
IBA15 195	1 x 95 + 16	20	273,00 ₺
IBA15 1120	1 x 120 + 16	20	274,00 ₺
IBA15 1150	1 x 150 + 25	20	274,00 ₺
IBA15 1185	1 x 185 + 25	20	279,00 ₺
IBA15 1240	1 x 240 + 25	20	285,00 ₺
IBA15 1300	1 x 300 + 25	20	295,00 ₺
IBA15 1400	1 x 400 + 35	20	312,00 ₺
IBA15 1500	1 x 500 + 35	20	315,00 ₺
IBA15 1630	1 x 630 + 35	20	395,00 ₺

20.8-36 kV



KOD CODE	KABLO KESİTİ CROSS SECTION	KOLİ ADETİ UNIT / BOX	FİYAT PRICE
IBA36 125	1X25+16	20	434,00 ₺
IBA36 135	1X35+16	20	434,00 ₺
IBA36 150	1X50+16	20	439,00 ₺
IBA36 170	1X70+16	20	439,00 ₺
IBA36 195	1X95+16	20	439,00 ₺
IBA36 1120	1X120+16	20	444,00 ₺
IBA36 1150	1X150+25	20	444,00 ₺
IBA36 1185	1X185+25	20	449,00 ₺
IBA36 1240	1X240+25	20	449,00 ₺
IBA36 1300	1X300+25	20	488,00 ₺
IBA36 1400	1X400+35	20	510,00 ₺
IBA36 1500	1X500+35	20	557,00 ₺
IBA36 1630	1X630+35	20	612,00 ₺

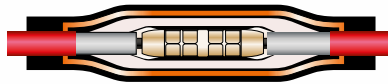

# O.G. ALÜMİNYUM ÜÇ DAMARLI ISI BÜZÜŞMELİ KABLO EK MUFLARI

M.V. ALUMINUM THREE CORES HEAT SHRINKABLE CABLE JOINTS



3.5-6 kV

KOD CODE	KABLO KESİTİ CROSS SECTION	FİYAT PRICE
IBA6 325	3 x 25 + 16	649,00 ₺
IBA6 335	3 x 35 + 16	649,00 ₺
IBA6 350	3 x 50 + 16	651,00 ₺
IBA6 370	3 x 70 + 16	651,00 ₺
IBA6 395	3 x 95 + 16	651,00 ₺
IBA6 3120	3 x 120 + 16	653,00 ₺
IBA6 3150	3 x 150 + 25	653,00 ₺
IBA6 3185	3 x 185 + 25	653,00 ₺
IBA6 3240	3 x 240 + 25	659,00 ₺
IBA6 3300	3 x 300 + 25	685,00 ₺
IBA6 3400	3 x 400 + 35	702,00 ₺
IBA6 3500	3 x 500 + 35	750,00 ₺

5.8-10 kV



KOD CODE	KABLO KESİTİ CROSS SECTION	FİYAT PRICE
IBA10 325	3 x 25 + 16	649,00 ₺
IBA10 335	3 x 35 + 16	649,00 ₺
IBA10 350	3 x 50 + 16	651,00 ₺
IBA10 370	3 x 70 + 16	651,00 ₺
IBA10 395	3 x 95 + 16	651,00 ₺
IBA10 3120	3 x 120 + 16	653,00 ₺
IBA10 3150	3 x 150 + 25	653,00 ₺
IBA10 3185	3 x 185 + 25	653,00 ₺
IBA10 3240	3 x 240 + 25	659,00 ₺
IBA10 3300	3 x 300 + 25	685,00 ₺
IBA10 3400	3 x 400 + 35	702,00 ₺
IBA10 3500	3 x 500 + 35	750,00 ₺



8.7-15 kV

KOD CODE	KABLO KESİTİ CROSS SECTION	FİYAT PRICE
IBA15 325	3 x 25 + 16	649,00 ₺
IBA15 335	3 x 35 + 16	649,00 ₺
IBA15 350	3 x 50 + 16	651,00 ₺
IBA15 370	3 x 70 + 16	651,00 ₺
IBA15 395	3 x 95 + 16	651,00 ₺
IBA15 3120	3 x 120 + 16	653,00 ₺
IBA15 3150	3 x 150 + 25	653,00 ₺
IBA15 3185	3 x 185 + 25	653,00 ₺
IBA15 3240	3 x 240 + 25	659,00 ₺
IBA15 3300	3 x 300 + 25	685,00 ₺
IBA15 3400	3 x 400 + 35	702,00 ₺
IBA15 3500	3 x 500 + 35	750,00 ₺

20.8-36 kV



KOD CODE	KABLO KESİTİ CROSS SECTION	FİYAT PRICE
IBA36 325	3 x 25 + 16	1.700,00 ₺
IBA36 335	3 x 35 + 16	1.700,00 ₺
IBA36 350	3 x 50 + 16	1.700,00 ₺
IBA36 370	3 x 70 + 16	1.702,00 ₺
IBA36 395	3 x 95 + 16	1.702,00 ₺
IBA36 3120	3 x 120 + 16	1.704,00 ₺
IBA36 3150	3 x 150 + 25	1.704,00 ₺
IBA36 3185	3 x 185 + 25	1.712,00 ₺
IBA36 3240	3 x 240 + 25	1.721,00 ₺
IBA36 3300	3 x 300 + 25	1.750,00 ₺
IBA36 3400	3 x 400 + 35	1.767,00 ₺
IBA36 3500	3 x 500 + 35	1.815,00 ₺

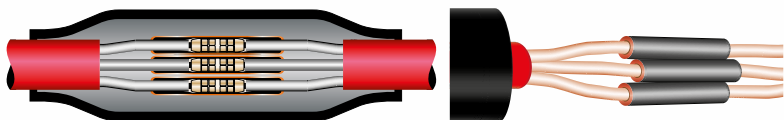



3.5-6 kV

KOD CODE	KABLO KESİTİ CROSS SECTION	KOLİ ADETİ UNIT / BOX	FİYAT PRICE
MIB6 125-195	1x25+16 - 1 x 95+16	20	300,00 ₺
MIB6 1120-1300	1x120+16 - 1x300+25	20	315,00 ₺

5.8-10 kV



KOD CODE	KABLO KESİTİ CROSS SECTION	KOLİ ADETİ UNIT / BOX	FİYAT PRICE
MIB10 125-195	1x25+16 - 1x95+16	20	300,00 ₺
MIB10 1120-1300	1x120+16 - 1x300+25	20	315,00 ₺

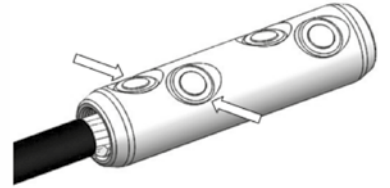
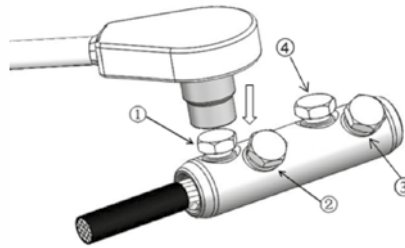
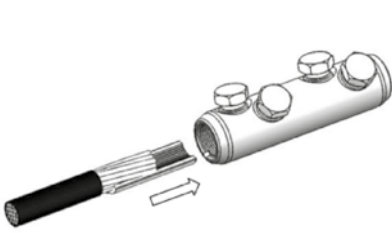

8.7-15 kV

KOD CODE	KABLO KESİTİ CROSS SECTION	KOLİ ADETİ UNIT / BOX	FİYAT PRICE
MIB15 125-195	1x25+16 - 1 x 95+16	20	300,00 ₺
MIB15 1120-1300	1x120+16 - 1x300+25	20	315,00 ₺

20.8-36 kV



KOD CODE	KABLO KESİTİ CROSS SECTION	KOLİ ADETİ UNIT / BOX	FİYAT PRICE
MIB36 135-170	1x35+16 - 1x70+16	20	465,00 ₺
MIB36 195-1150	1x95+16 - 1x150+16	20	480,00 ₺
MIB36 1185-1400	1x185+25 - 1x400+25	20	495,00 ₺
MIB36 1500-1630	1x1500+35 - 1x630+35	20	630,00 ₺

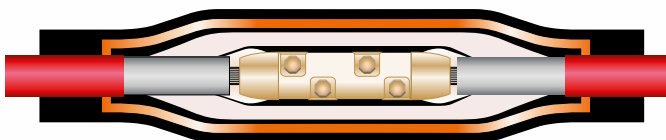

# O.G. MEKANİK ÜÇ DAMARLI ISI BÜZÜŞMELİ KABLO EK MUFLARI

M.V. BOLTED THREE CORE HEAT SHRINKABLE CABLE JOINTS



3.5-6 kV



5.8-10 kV

KOD CODE	KABLO KESİTİ CROSS SECTION	KOLİ ADETİ UNIT / BOX	FİYAT PRICE
MIB6 325-395	3x25+16-3x95+16	20	680,00 ₺
MIB6 3120-3300	3x120+16-3x300+25	20	695,00 ₺

KOD CODE	KABLO KESİTİ CROSS SECTION	KOLİ ADETİ UNIT / BOX	FİYAT PRICE
MIB10 325-395	3x25+16-3x95+16	20	680,00 ₺
MIB10 3120-3300	3x120+16-3x300+25	20	695,00 ₺

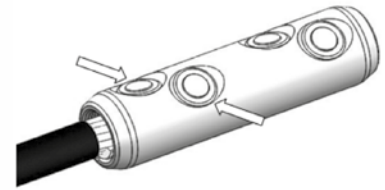
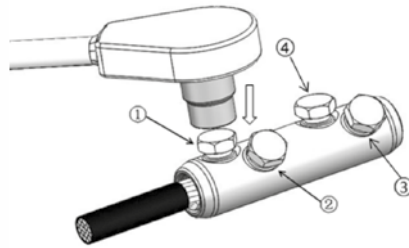
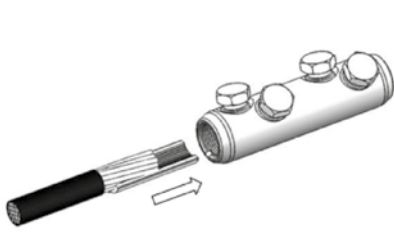

8.7-15 kV

20.8-36 kV



KOD CODE	KABLO KESİTİ CROSS SECTION	KOLİ ADETİ UNIT / BOX	FİYAT PRICE
MIB15 325-395	3x25+16-3x95+16	20	680,00 ₺
MIB15 3120-3300	3x120+16-3x300+25	20	695,00 ₺

KOD CODE	KABLO KESİTİ CROSS SECTION	KOLİ ADETİ UNIT / BOX	FİYAT PRICE
MIB36 335-370	3x25+16-3x95+16	20	1.730,00 ₺
MIB36 395-3150	3x120+16-3x300+25	20	1.745,00 ₺
MIB36 3185-3300	3x185+25-3x300+25	20	1.760,00 ₺
MIB36 3400-3500	3x400+35-3x500+35	20	1.950,00 ₺

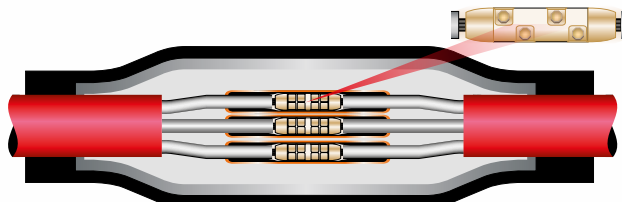



KOD CODE	KABLO KESİTİ CROSS SECTION	FİYAT PRICE
ZIB6 125	1 x 25 + 16	500,00 ₺
ZIB6 135	1 x 35 + 16	500,00 ₺
ZIB6 150	1 x 50 + 16	500,00 ₺
ZIB6 170	1 x 70 + 16	502,50 ₺
ZIB6 195	1 x 95 + 16	502,50 ₺
ZIB6 1120	1 x 120 + 16	504,75 ₺
ZIB6 1150	1 x 150 + 25	504,75 ₺
ZIB6 1185	1 x 185 + 25	509,35 ₺
ZIB6 1240	1 x 240 + 25	517,45 ₺
ZIB6 1300	1 x 300 + 25	534,30 ₺
ZIB6 1400	1 x 400 + 35	551,65 ₺
ZIB6 1500	1 x 500 + 35	596,00 ₺

5.8-10 kV



KOD CODE	KABLO KESİTİ CROSS SECTION	FİYAT PRICE
ZIB10 125	1 x 25 + 16	500,00 ₺
ZIB10 135	1 x 35 + 16	500,00 ₺
ZIB10 150	1 x 50 + 16	500,00 ₺
ZIB10 170	1 x 70 + 16	502,50 ₺
ZIB10 195	1 x 95 + 16	502,50 ₺
ZIB10 1120	1 x 120 + 16	504,75 ₺
ZIB10 1150	1 x 150 + 25	504,75 ₺
ZIB10 1185	1 x 185 + 25	509,35 ₺
ZIB10 1240	1 x 240 + 25	517,45 ₺
ZIB10 1300	1 x 300 + 25	534,30 ₺
ZIB10 1400	1 x 400 + 35	551,65 ₺
ZIB10 1500	1 x 500 + 35	596,00 ₺



KOD CODE	KABLO KESİTİ CROSS SECTION	FİYAT PRICE
ZIB15 125	1 x 25 + 16	500,00 ₺
ZIB15 135	1 x 35 + 16	500,00 ₺
ZIB15 150	1 x 50 + 16	500,00 ₺
ZIB15 170	1 x 70 + 16	502,50 ₺
ZIB15 195	1 x 95 + 16	502,50 ₺
ZIB15 1120	1 x 120 + 16	504,75 ₺
ZIB15 1150	1 x 150 + 25	504,75 ₺
ZIB15 1185	1 x 185 + 25	509,35 ₺
ZIB15 1240	1 x 240 + 25	517,45 ₺
ZIB15 1300	1 x 300 + 25	534,30 ₺
ZIB15 1400	1 x 400 + 35	551,65 ₺
ZIB15 1500	1 x 500 + 35	596,00 ₺

20.8-36 kV



KOD CODE	KABLO KESİTİ CROSS SECTION	FİYAT PRICE
ZIB36 125	1 x 25 + 16	704,85 ₺
ZIB36 135	1 x 35 + 16	704,85 ₺
ZIB36 150	1 x 50 + 16	707,00 ₺
ZIB36 170	1 x 70 + 16	707,00 ₺
ZIB36 195	1 x 95 + 16	707,00 ₺
ZIB36 1120	1 x 120 + 16	709,35 ₺
ZIB36 1150	1 x 150 + 25	709,35 ₺
ZIB36 1185	1 x 185 + 25	714,00 ₺
ZIB36 1240	1 x 240 + 25	725,40 ₺
ZIB36 1300	1 x 300 + 25	750,00 ₺
ZIB36 1400	1 x 400 + 35	762,45 ₺
ZIB36 1500	1 x 500 + 35	816,40 ₺

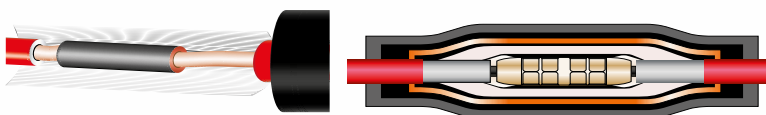

# O.G. ZIRHLI BAKIR ÜÇ DAMARLI ISI BÜZÜŞMELİ KABLO EK MUFLARI

M.V. ARMoured COPPER THREE CORES HEAT SHRINKABLE CABLE JOINTS



3.5-6 kV

5.8-10 kV



KOD CODE	KABLO KESİTİ CROSS SECTION	FİYAT PRICE
ZIB6 325	3 x 25 + 16	932,00 ₺
ZIB6 335	3 x 35 + 16	932,00 ₺
ZIB6 350	3 x 50 + 16	934,50 ₺
ZIB6 370	3 x 70 + 16	934,50 ₺
ZIB6 395	3 x 95 + 16	934,50 ₺
ZIB6 3120	3 x 120 + 16	936,85 ₺
ZIB6 3150	3 x 150 + 25	936,85 ₺
ZIB6 3185	3 x 185 + 25	936,85 ₺
ZIB6 3240	3 x 240 + 25	943,65 ₺
ZIB6 3300	3 x 300 + 25	975,40 ₺
ZIB6 3400	3 x 400 + 35	992,70 ₺
ZIB6 3500	3 x 500 + 35	1.040,00 ₺

KOD CODE	KABLO KESİTİ CROSS SECTION	FİYAT PRICE
ZIB10 325	3 x 25 + 16	932,00 ₺
ZIB10 335	3 x 35 + 16	932,00 ₺
ZIB10 350	3 x 50 + 16	934,50 ₺
ZIB10 370	3 x 70 + 16	934,50 ₺
ZIB10 395	3 x 95 + 16	934,50 ₺
ZIB10 3120	3 x 120 + 16	936,85 ₺
ZIB10 3150	3 x 150 + 25	936,85 ₺
ZIB10 3185	3 x 185 + 25	936,85 ₺
ZIB10 3240	3 x 240 + 25	943,65 ₺
ZIB10 3300	3 x 300 + 25	975,40 ₺
ZIB10 3400	3 x 400 + 35	992,70 ₺
ZIB10 3500	3 x 500 + 35	1.040,00 ₺



8.7-15 kV

20.8-36 kV



KOD CODE	KABLO KESİTİ CROSS SECTION	FİYAT PRICE
ZIB15 325	3 x 25 + 16	932,00 ₺
ZIB15 335	3 x 35 + 16	932,00 ₺
ZIB15 350	3 x 50 + 16	934,50 ₺
ZIB15 370	3 x 70 + 16	934,50 ₺
ZIB15 395	3 x 95 + 16	934,50 ₺
ZIB15 3120	3 x 120 + 16	936,85 ₺
ZIB15 3150	3 x 150 + 25	936,85 ₺
ZIB15 3185	3 x 185 + 25	936,85 ₺
ZIB15 3240	3 x 240 + 25	943,65 ₺
ZIB15 3300	3 x 300 + 25	975,40 ₺
ZIB15 3400	3 x 400 + 35	992,70 ₺
ZIB15 3500	3 x 500 + 35	1.040,00 ₺

KOD CODE	KABLO KESİTİ CROSS SECTION	FİYAT PRICE
ZIB36 325	3 x 25 + 16	2.141,90 ₺
ZIB36 335	3 x 35 + 16	2.141,90 ₺
ZIB36 350	3 x 50 + 16	2.141,90 ₺
ZIB36 370	3 x 70 + 16	2.144,00 ₺
ZIB36 395	3 x 95 + 16	2.144,00 ₺
ZIB36 3120	3 x 120 + 16	2.146,00 ₺
ZIB36 3150	3 x 150 + 25	2.146,00 ₺
ZIB36 3185	3 x 185 + 25	2.148,65 ₺
ZIB36 3240	3 x 240 + 25	2.160,00 ₺
ZIB36 3300	3 x 300 + 25	2.198,60 ₺
ZIB36 3400	3 x 400 + 35	2.216,30 ₺
ZIB36 3500	3 x 500 + 35	2.263,90 ₺





5.8-10 kV



KOD CODE	KABLO KESİTİ CROSS SECTION	FİYAT PRICE
ZIBA6 125	1 x 25 + 16	499,00 ₺
ZIBA6 135	1 x 35 + 16	499,00 ₺
ZIBA6 150	1 x 50 + 16	499,00 ₺
ZIBA6 170	1 x 70 + 16	501,00 ₺
ZIBA6 195	1 x 95 + 16	501,00 ₺
ZIBA6 1120	1 x 120 + 16	503,00 ₺
ZIBA6 1150	1 x 150 + 25	503,00 ₺
ZIBA6 1185	1 x 185 + 25	508,00 ₺
ZIBA6 1240	1 x 240 + 25	515,00 ₺
ZIBA6 1300	1 x 300 + 25	532,00 ₺
ZIBA6 1400	1 x 400 + 35	550,00 ₺
ZIBA6 1500	1 x 500 + 35	595,00 ₺

KOD CODE	KABLO KESİTİ CROSS SECTION	FİYAT PRICE
ZIBA10 125	1 x 25 + 16	499,00 ₺
ZIBA10 135	1 x 35 + 16	499,00 ₺
ZIBA10 150	1 x 50 + 16	499,00 ₺
ZIBA10 170	1 x 70 + 16	501,00 ₺
ZIBA10 195	1 x 95 + 16	501,00 ₺
ZIBA10 1120	1 x 120 + 16	503,00 ₺
ZIBA10 1150	1 x 150 + 25	503,00 ₺
ZIBA10 1185	1 x 185 + 25	508,00 ₺
ZIBA10 1240	1 x 240 + 25	515,00 ₺
ZIBA10 1300	1 x 300 + 25	532,00 ₺
ZIBA10 1400	1 x 400 + 35	550,00 ₺
ZIBA10 1500	1 x 500 + 35	595,00 ₺



20.8-36 kV



KOD CODE	KABLO KESİTİ CROSS SECTION	FİYAT PRICE
ZIBA15 125	1 x 25 + 16	499,00 ₺
ZIBA15 135	1 x 35 + 16	499,00 ₺
ZIBA15 150	1 x 50 + 16	499,00 ₺
ZIBA15 170	1 x 70 + 16	501,00 ₺
ZIBA15 195	1 x 95 + 16	501,00 ₺
ZIBA15 1120	1 x 120 + 16	503,00 ₺
ZIBA15 1150	1 x 150 + 25	503,00 ₺
ZIBA15 1185	1 x 185 + 25	508,00 ₺
ZIBA15 1240	1 x 240 + 25	515,00 ₺
ZIBA15 1300	1 x 300 + 25	532,00 ₺
ZIBA15 1400	1 x 400 + 35	550,00 ₺
ZIBA15 1500	1 x 500 + 35	595,00 ₺

KOD CODE	KABLO KESİTİ CROSS SECTION	FİYAT PRICE
ZIBA36 125	1 x 25 + 16	703,00 ₺
ZIBA36 135	1 x 35 + 16	703,00 ₺
ZIBA36 150	1 x 50 + 16	705,00 ₺
ZIBA36 170	1 x 70 + 16	705,00 ₺
ZIBA36 195	1 x 95 + 16	705,00 ₺
ZIBA36 1120	1 x 120 + 16	707,00 ₺
ZIBA36 1150	1 x 150 + 25	707,00 ₺
ZIBA36 1185	1 x 185 + 25	712,00 ₺
ZIBA36 1240	1 x 240 + 25	723,00 ₺
ZIBA36 1300	1 x 300 + 25	748,00 ₺
ZIBA36 1400	1 x 400 + 35	760,00 ₺
ZIBA36 1500	1 x 500 + 35	815,00 ₺

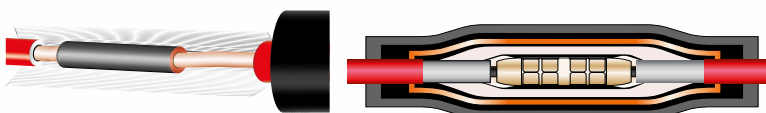



# O.G. ZIRHLI ALÜMİNYUM ÜÇ DAMARLI ISI BÜZÜŞMELİ KABLO EK MUFLARI

M.V. ARMURED ALUMINUM THREE CORES HEAT SHRINKABLE CABLE JOINTS



3.5-6 kV

5.8-10 kV



KOD CODE	KABLO KESİTİ CROSS SECTION	FİYAT PRICE
ZIBA6 325	3 x 25 + 16	930,00 ₺
ZIBA6 335	3 x 35 + 16	930,00 ₺
ZIBA6 350	3 x 50 + 16	932,00 ₺
ZIBA6 370	3 x 70 + 16	932,00 ₺
ZIBA6 395	3 x 95 + 16	932,00 ₺
ZIBA6 3120	3 x 120 + 16	935,00 ₺
ZIBA6 3150	3 x 150 + 25	935,00 ₺
ZIBA6 3185	3 x 185 + 25	935,00 ₺
ZIBA6 3240	3 x 240 + 25	941,00 ₺
ZIBA6 3300	3 x 300 + 25	973,00 ₺
ZIBA6 3400	3 x 400 + 35	990,00 ₺
ZIBA6 3500	3 x 500 + 35	1.038,00 ₺

KOD CODE	KABLO KESİTİ CROSS SECTION	FİYAT PRICE
ZIBA10 325	3 x 25 + 16	930,00 ₺
ZIBA10 335	3 x 35 + 16	930,00 ₺
ZIBA10 350	3 x 50 + 16	932,00 ₺
ZIBA10 370	3 x 70 + 16	932,00 ₺
ZIBA10 395	3 x 95 + 16	932,00 ₺
ZIBA10 3120	3 x 120 + 16	935,00 ₺
ZIBA10 3150	3 x 150 + 25	935,00 ₺
ZIBA10 3185	3 x 185 + 25	935,00 ₺
ZIBA10 3240	3 x 240 + 25	941,00 ₺
ZIBA10 3300	3 x 300 + 25	973,00 ₺
ZIBA10 3400	3 x 400 + 35	990,00 ₺
ZIBA10 3500	3 x 500 + 35	1.038,00 ₺



8.7-15 kV

20.8-36 kV



KOD CODE	KABLO KESİTİ CROSS SECTION	FİYAT PRICE
ZIBA15 325	3 x 25 + 16	930,00 ₺
ZIBA15 335	3 x 35 + 16	930,00 ₺
ZIBA15 350	3 x 50 + 16	932,00 ₺
ZIBA15 370	3 x 70 + 16	932,00 ₺
ZIBA15 395	3 x 95 + 16	932,00 ₺
ZIBA15 3120	3 x 120 + 16	935,00 ₺
ZIBA15 3150	3 x 150 + 25	935,00 ₺
ZIBA15 3185	3 x 185 + 25	935,00 ₺
ZIBA15 3240	3 x 240 + 25	941,00 ₺
ZIBA15 3300	3 x 300 + 25	973,00 ₺
ZIBA15 3400	3 x 400 + 35	990,00 ₺
ZIBA15 3500	3 x 500 + 35	1.038,00 ₺

KOD CODE	KABLO KESİTİ CROSS SECTION	FİYAT PRICE
ZIBA36 325	3 x 25 + 16	2.140,00 ₺
ZIBA36 335	3 x 35 + 16	2.140,00 ₺
ZIBA36 350	3 x 50 + 16	2.140,00 ₺
ZIBA36 370	3 x 70 + 16	2.142,00 ₺
ZIBA36 395	3 x 95 + 16	2.142,00 ₺
ZIBA36 3120	3 x 120 + 16	2.145,00 ₺
ZIBA36 3150	3 x 150 + 25	2.145,00 ₺
ZIBA36 3185	3 x 185 + 25	2.146,00 ₺
ZIBA36 3240	3 x 240 + 25	2.158,00 ₺
ZIBA36 3300	3 x 300 + 25	2.196,00 ₺
ZIBA36 3400	3 x 400 + 35	2.215,00 ₺
ZIBA36 3500	3 x 500 + 35	2.261,00 ₺

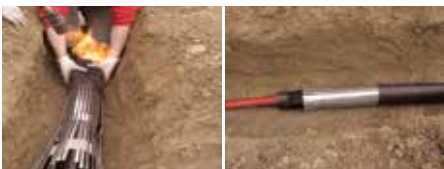



KOD CODE	KABLO KESİTİ CROSS SECTION	FİYAT PRICE
MZIB6 125-195	1x25+16 - 1x95+16	525,00 ₺
MZIB6 1120-1300	1x120+16 - 1x300+25	550,00 ₺



KOD CODE	KABLO KESİTİ CROSS SECTION	FİYAT PRICE
MZIB10 125-195	1x25+16 - 1x95+16	525,00 ₺
MZIB10 1120-1300	1x120+16 - 1x300+25	550,00 ₺

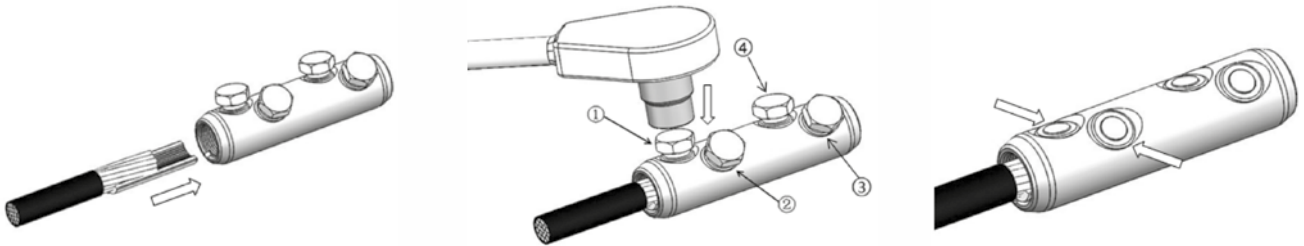

KOD CODE	KABLO KESİTİ CROSS SECTION	FİYAT PRICE
MZIB15 125-195	1x25+16 - 1x95+16	525,00 ₺
MZIB15 1120-1300	1x120+16 - 1x300+25	550,00 ₺



KOD CODE	KABLO KESİTİ CROSS SECTION	FİYAT PRICE
MZIB36 135-170	1x35+16 - 1x70+16	730,00 ₺
MZIB36 195-1150	1x95+16 - 1x150+16	745,00 ₺
MZIB36 1185-1300	1x185+25 - 1x400+25	760,00 ₺
MZIB36 1400-1630	1x1500+35 - 1x630+35	800,00 ₺

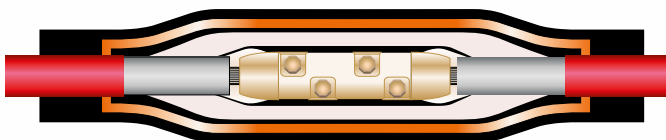

# O.G. ZIRHLI MEKANİK ÜÇ DAMARLI ISI BÜZÜŞMELİ KABLO EK MUFLARI

M.V. ARMURED BOLTED THREE CORES HEAT SHRINKABLE CABLE JOINTS



3.5-6 kV

5.8-10 kV



KOD CODE	KABLO KESİTİ CROSS SECTION	FİYAT PRICE
MZIB6 325-395	3x25+16 - 3x95+16	955,00 ₺
MZIB6 3120-3300	3x120+16 - 3x300+25	1.000,00 ₺

KOD CODE	KABLO KESİTİ CROSS SECTION	FİYAT PRICE
MZIB10 325-395	3x25+16 - 3x95+16	955,00 ₺
MZIB10 3120-3300	3x120+16 - 3x300+25	1.000,00 ₺

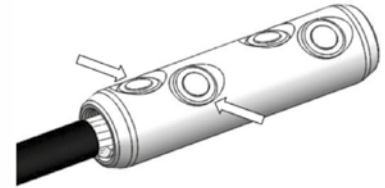
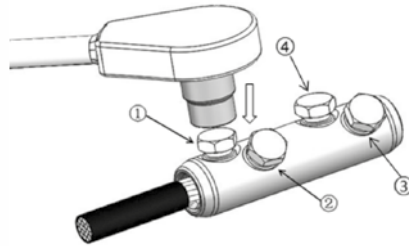
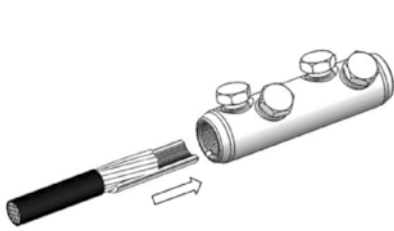

8.7-15 kV

20.8-36 kV



KOD CODE	KABLO KESİTİ CROSS SECTION	FİYAT PRICE
MZIB15 325-395	3x25+16 - 3x95+16	955,00 ₺
MZIB15 3120-3300	3x120+16 - 3x300+25	1.000,00 ₺

KOD CODE	KABLO KESİTİ CROSS SECTION	FİYAT PRICE
MZIB36 335-370	3x25+16 - 3x95+16	2.165,00 ₺
MZIB36 395-3150	3x120+16 - 3x300+25	2.180,00 ₺
MZIB36 3185-3300	3x185+25 - 3x300+25	2.195,00 ₺
MZIB36 3400-3500	3x400+35 - 3x500+35	2.240,00 ₺

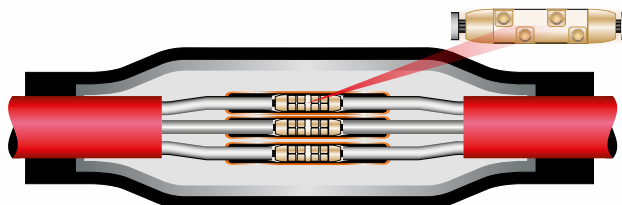

Bina içi ve dışı  
enerji dağıtımında  
optimal çözüm



## A.G. PABUÇSUZ REÇİNELİ KABLO BAŞLIKLARI

L.V. WITHOUT LUG RESIN CABLE TERMINATIONS



0.6-1 kV

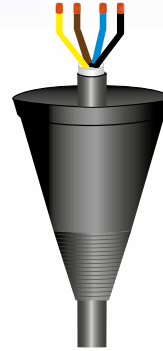

KOD CODE	KABLO KESİTİ CROSS SECTION	KOLİ ADETİ UNIT / BOX	FİYAT PRICE
PKB 01	2 x 1,5 - 3 x 50 + 25	50	16,00 ₺



0.6-1 kV



KOD CODE	KABLO KESİTİ CROSS SECTION	KOLİ ADETİ UNIT / BOX	FİYAT PRICE
PKB 02	3 x 70 + 35 - 3 x 95 + 50	50	23,00 ₺



0.6-1 kV

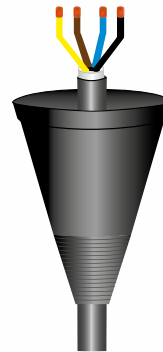

KOD CODE	KABLO KESİTİ CROSS SECTION	KOLİ ADETİ UNIT / BOX	FİYAT PRICE
PKB 03	3 x 120 + 70 - 3 x 150 + 70	32	40,00 ₺



0.6-1 kV

KOD CODE	KABLO KESİTİ CROSS SECTION	KOLİ ADETİ UNIT / BOX	FİYAT PRICE
B1 504 - B1 506	5 x 4 - 5 x 6	50	45,90 ₺
B1 510	5 x 10	50	46,60 ₺
B1 516	5 x 16	50	48,50 ₺
B1 4105 - B1 4205	4 x 1,5 - 4 x 2,5	50	38,45 ₺
B1 404 - B1 406	4 x 4 - 4 x 6	50	38,45 ₺
B1 410	4 x 10	50	45,30 ₺
B1 416	4 x 16	50	46,60 ₺
B1 31610	3 x 16 + 10	50	46,60 ₺

0.6-1 kV



KOD CODE	KABLO KESİTİ CROSS SECTION	KOLİ ADETİ UNIT / BOX	FİYAT PRICE
B1 315 - B1 304	3 x 1,5 - 3 x 4	50	37,95 ₺
B1 306 - B1 310	3 x 6 - 3 x 10	50	39,95 ₺
B1 316 - B1 325	3 x 16 - 3 x 25	50	44,55 ₺
B1 335 - B1 350	3 x 35 - 3 x 50	50	48,65 ₺
B1 370 - B1 395	3 x 70 - 3 x 95	50	53,55 ₺
B1 3120 - B1 3150	3 x 120 - 3 x 150	32	87,65 ₺
B1 3185	3 x 185	32	96,75 ₺
B1 3240	3 x 240	32	100,00 ₺



0.6-1 kV



KOD CODE	KABLO KESİTİ CROSS SECTION	KOLİ ADETİ UNIT / BOX	FİYAT PRICE
B1 32516	3 x 25 + 16	50	47,00 ₺
B1 33516	3 x 35 + 16	50	51,75 ₺
B1 35025	3 x 50 + 25	50	51,75 ₺
B1 37035	3 x 70 + 35	50	60,00 ₺
B1 39550	3 x 95 + 50	50	60,00 ₺

0.6-1 kV



KOD CODE	KABLO KESİTİ CROSS SECTION	KOLİ ADETİ UNIT / BOX	FİYAT PRICE
B1 215 - B1 204	2 x 1,5 - 2 x 4	50	37,00 ₺
B1 206 - B1 210	2 x 6 - 2 x 10	50	39,00 ₺
B1 216 - B1 225	2 x 16 - 2 x 25	50	40,80 ₺
B1 235 - B1 250	2 x 35 - 2 x 50	50	46,95 ₺
B1 270 - B1 295	2 x 70 - 2 x 95	50	51,75 ₺
B1 2120 - B1 2150	2 x 120 - 2 x 150	32	84,75 ₺
B1 2185	2 x 185	32	94,00 ₺
B1 2240	2 x 240	32	97,15 ₺



0.6-1 kV

KOD CODE	KABLO KESİTİ CROSS SECTION	KOLİ ADETİ UNIT / BOX	FİYAT PRICE
B1 31207	3 x 120 + 70	32	90,55 ₺
B1 31507	3 x 150 + 70	32	90,55 ₺
B1 31859	3 x 185 + 95	32	105,40 ₺
B1 32401	3 x 240 + 120	32	108,20 ₺

0.6-1 kV



KOD CODE	KABLO KESİTİ CROSS SECTION	KOLİ ADETİ UNIT / BOX	FİYAT PRICE
B1 115 - B1 104	1 x 1,5 - 1 x 4	50	34,50 ₺
B1 106 - B1 110	1 x 6 - 1 x 10	50	37,65 ₺
B1 116 - B1 125	1 x 16 - 1 x 25	50	40,80 ₺
B1 135 - B1 150	1 x 35 - 1 x 50	50	45,40 ₺
B1 170 - B1 195	1 x 70 - 1 x 95	50	50,25 ₺
B1 1120 - B1 1150	1 x 120 - 1 x 150	32	60,35 ₺
B1 1185	1 x 185	32	65,95 ₺
B1 1240	1 x 240	32	69,00 ₺

\* Alüminyum iletkenli üretim yapılır. / \* Production of aluminium conductors are made

# A.G.ÇOK DAMARLI ISI BÜZÜŞMELİ KABLO BAŞLIKLARI

L.V. MULTI CORES HEAT SHRINKABLE CABLE TERMINATIONS



PABUÇLU WITH LUG CODE	KABLO KESİTİ CROSS SECTION	FİYAT PRICE	PABUÇSUZ WITHOUT LUG CODE	KABLO KESİTİ CROSS SECTION	FİYAT PRICE	PABUÇLU WITH LUG CODE	KABLO KESİTİ CROSS SECTION	FİYAT PRICE	PABUÇSUZ WITHOUT LUG CODE	KABLO KESİTİ CROSS SECTION	FİYAT PRICE
4 DAMARLI PABUÇLU KABLO BAŞLIĞI			4 DAMARLI PABUÇSUZ KABLO BAŞLIĞI			4 DAMARLI PABUÇLU KABLO BAŞLIĞI			4 DAMARLI PABUÇSUZ KABLO BAŞLIĞI		
IBB1 4205	4 x 2,5	62,00 ₺	IBBX1 4205	4 x 2,5	42,00 ₺	IBB1 4300	4 x 300	212,00 ₺	IBBX1 4300	4 x 300	100,00 ₺
IBB1 404	4 x 4	62,00 ₺	IBBX1 404	4 x 4	42,00 ₺	IBB1 4400	4 x 400	212,00 ₺	IBBX1 4400	4 x 400	100,00 ₺
IBB1 406	4 x 6	62,00 ₺	IBBX1 406	4 x 6	42,00 ₺	IBB1 31610	3 x 16+10	64,00 ₺	IBBX1 31610	3 x 16+10	42,00 ₺
IBB1 410	4 x 10	63,00 ₺	IBBX1 410	4 x 10	42,00 ₺	IBB1 32516	3 x 25+16	71,00 ₺	IBBX1 32516	3 x 25+16	42,00 ₺
IBB1 416	4 x 16	65,00 ₺	IBBX1 416	4 x 16	42,00 ₺	IBB1 33516	3 x 35+16	76,00 ₺	IBBX1 33516	3 x 35+16	67,00 ₺
IBB1 425	4 x 25	73,00 ₺	IBBX1 425	4 x 25	42,00 ₺	IBB1 35025	3 x 50+25	83,00 ₺	IBBX1 35025	3 x 50+25	67,00 ₺
IBB1 435	4 x 35	78,00 ₺	IBBX1 435	4 x 35	67,00 ₺	IBB1 37035	3 x 70+35	95,00 ₺	IBBX1 37035	3 x 70+35	67,00 ₺
IBB1 450	4 x 50	85,00 ₺	IBBX1 450	4 x 50	67,00 ₺	IBB1 39550	3 x 95+50	100,00 ₺	IBBX1 39550	3 x 95+50	67,00 ₺
IBB1 470	4 x 70	96,50 ₺	IBBX1 470	4 x 70	67,00 ₺	IBB1 31207	3 x 120+70	114,00 ₺	IBBX1 31207	3 x 120+70	84,00 ₺
IBB1 495	4 x 95	103,00 ₺	IBBX1 495	4 x 95	67,00 ₺	IBB1 31507	3 x 150+70	120,00 ₺	IBBX1 31507	3 x 150+70	84,00 ₺
IBB1 4120	4 x 120	119,00 ₺	IBBX1 4120	4 x 120	84,00 ₺	IBB1 31859	3 x 185+95	143,00 ₺	IBBX1 31859	3 x 185+95	84,00 ₺
IBB1 4150	4 x 150	126,00 ₺	IBBX1 4150	4 x 150	84,00 ₺	IBB1 32401	3 x 240+120	162,00 ₺	IBBX1 32401	3 x 240+120	100,00 ₺
IBB1 4185	4 x 185	148,00 ₺	IBBX1 4185	4 x 185	84,00 ₺	IBB1 33001	3 x 300+150	205,00 ₺	IBBX1 33001	3 x 300+150	100,00 ₺
IBB1 4240	4 x 240	162,00 ₺	IBBX1 4240	4 x 240	100,00 ₺	IBB1 34001	3 x 400+185	217,00 ₺	IBBX1 34001	3 x 400+185	100,00 ₺

PABUÇLU WITH LUG CODE	KABLO KESİTİ CROSS SECTION	FİYAT PRICE	PABUÇSUZ WITHOUT LUG CODE	KABLO KESİTİ CROSS SECTION	FİYAT PRICE	PABUÇLU WITH LUG CODE	KABLO KESİTİ CROSS SECTION	FİYAT PRICE	PABUÇSUZ WITHOUT LUG CODE	KABLO KESİTİ CROSS SECTION	FİYAT PRICE
2 DAMARLI PABUÇLU KABLO BAŞLIĞI			2 DAMARLI PABUÇSUZ KABLO BAŞLIĞI			5 DAMARLI PABUÇLU KABLO BAŞLIĞI			5 DAMARLI PABUÇSUZ KABLO BAŞLIĞI		
IBB1 2205	2 x 2,5	57,00 ₺	IBBX1 2205	2 x 2,5	37,00 ₺	IBB1 5205	5 x 2,5	72,00 ₺	IBBX1 5205	5 x 2,5	54,00 ₺
IBB1 204	2 x 4	57,00 ₺	IBBX1 204	2 x 4	37,00 ₺	IBB1 504	5 x 4	72,00 ₺	IBBX1 504	5 x 4	54,00 ₺
IBB1 206	2 x 6	57,00 ₺	IBBX1 206	2 x 6	37,00 ₺	IBB1 506	5 x 6	72,00 ₺	IBBX1 506	5 x 6	54,00 ₺
IBB1 210	2 x 10	61,00 ₺	IBBX1 210	2 x 10	37,00 ₺	IBB1 510	5 x 10	83,00 ₺	IBBX1 510	5 x 10	54,00 ₺
IBB1 216	2 x 16	61,00 ₺	IBBX1 216	2 x 16	37,00 ₺	IBB1 516	5 x 16	86,00 ₺	IBBX1 516	5 x 16	54,00 ₺
IBB1 225	2 x 25	68,00 ₺	IBBX1 225	2 x 25	37,00 ₺	IBB1 525	5 x 25	95,00 ₺	IBBX1 525	5 x 25	54,00 ₺
IBB1 235	2 x 35	72,00 ₺	IBBX1 235	2 x 35	62,00 ₺	IBB1 535	5 x 35	100,00 ₺	IBBX1 535	5 x 35	89,00 ₺
IBB1 250	2 x 50	92,00 ₺	IBBX1 250	2 x 50	62,00 ₺	IBB1 550	5 x 50	110,00 ₺	IBBX1 550	5 x 50	89,00 ₺
IBB1 270	2 x 70	92,00 ₺	IBBX1 270	2 x 70	62,00 ₺	IBB1 570	5 x 70	126,00 ₺	IBBX1 570	5 x 70	89,00 ₺
IBB1 295	2 x 95	98,00 ₺	IBBX1 295	2 x 95	62,00 ₺	IBB1 595	5 x 95	133,00 ₺	IBBX1 595	5 x 95	89,00 ₺
IBB1 2120	2 x 120	112,00 ₺	IBBX1 2120	2 x 120	78,00 ₺	IBB1 5120	5 x 120	152,00 ₺	IBBX1 5120	5 x 120	108,00 ₺
IBB1 2150	2 x 150	117,00 ₺	IBBX1 2150	2 x 150	78,00 ₺	IBB1 5150	5 x 150	158,00 ₺	IBBX1 5150	5 x 150	108,00 ₺
IBB1 2185	2 x 185	141,00 ₺	IBBX1 2185	2 x 185	78,00 ₺	IBB1 5185	5 x 185	189,00 ₺	IBBX1 5185	5 x 185	108,00 ₺

\* Alüminyum iletkenli üretim yapılır. / \* Production of aluminium conductors are made



3.5-6 kV



5.8-10 kV

KOD CODE	KABLO KESİTİ CROSS SECTION	KOLİ ADETİ UNIT / BOX	FİYAT PRICE
IBH6 125	1 x 25 + 16	33	99,00 ₺
IBH6 135	1 x 35 + 16	33	99,00 ₺
IBH6 150	1 x 50 + 16	33	99,00 ₺
IBH6 170	1 x 70 + 16	33	101,00 ₺
IBH6 195	1 x 95 + 16	33	101,00 ₺
IBH6 1120	1 x 120 + 16	33	103,00 ₺
IBH6 1150	1 x 150 + 25	33	103,00 ₺
IBH6 1185	1 x 185 + 25	33	106,00 ₺
IBH6 1240	1 x 240 + 25	33	110,00 ₺
IBH6 1300	1 x 300 + 25	33	138,00 ₺
IBH6 1400	1 x 400 + 35	33	157,00 ₺
IBH6 1500	1 x 500 + 35	33	209,00 ₺
IBH6 1630	1 x 630 + 35	33	253,00 ₺

KOD CODE	KABLO KESİTİ CROSS SECTION	KOLİ ADETİ UNIT / BOX	FİYAT PRICE
IBH10 125	1 x 25 + 16	33	99,00 ₺
IBH10 135	1 x 35 + 16	33	99,00 ₺
IBH10 150	1 x 50 + 16	33	99,00 ₺
IBH10 170	1 x 70 + 16	33	101,00 ₺
IBH10 195	1 x 95 + 16	33	101,00 ₺
IBH10 1120	1 x 120 + 16	33	103,00 ₺
IBH10 1150	1 x 150 + 25	33	103,00 ₺
IBH10 1185	1 x 185 + 25	33	106,00 ₺
IBH10 1240	1 x 240 + 25	33	110,00 ₺
IBH10 1300	1 x 300 + 25	33	138,00 ₺
IBH10 1400	1 x 400 + 35	33	157,00 ₺
IBH10 1500	1 x 500 + 35	33	209,00 ₺
IBH10 1630	1 x 630 + 35	33	253,00 ₺

HARİCİ



8.7-15 kV



20.8-36 kV

KOD CODE	KABLO KESİTİ CROSS SECTION	KOLİ ADETİ UNIT / BOX	FİYAT PRICE
IBH15 125	1 x 25 + 16	33	99,00 ₺
IBH15 135	1 x 35 + 16	33	99,00 ₺
IBH15 150	1 x 50 + 16	33	99,00 ₺
IBH15 170	1 x 70 + 16	33	101,00 ₺
IBH15 195	1 x 95 + 16	33	101,00 ₺
IBH15 1120	1 x 120 + 16	33	103,00 ₺
IBH15 1150	1 x 150 + 25	33	103,00 ₺
IBH15 1185	1 x 185 + 25	33	106,00 ₺
IBH15 1240	1 x 240 + 25	33	110,00 ₺
IBH15 1300	1 x 300 + 25	33	138,00 ₺
IBH15 1400	1 x 400 + 35	33	157,00 ₺
IBH15 1500	1 x 500 + 35	33	209,00 ₺
IBH15 1630	1 x 630 + 35	33	253,00 ₺

KOD CODE	KABLO KESİTİ CROSS SECTION	KOLİ ADETİ UNIT / BOX	FİYAT PRICE
IBH36 125	1 x 25 + 16	33	149,00 ₺
IBH36 135	1 x 35 + 16	33	149,00 ₺
IBH36 150	1 x 50 + 16	33	149,00 ₺
IBH36 170	1 x 70 + 16	33	152,00 ₺
IBH36 195	1 x 95 + 16	33	152,00 ₺
IBH36 1120	1 x 120 + 16	33	154,00 ₺
IBH36 1150	1 x 150 + 25	33	154,00 ₺
IBH36 1185	1 x 185 + 25	33	156,00 ₺
IBH36 1240	1 x 240 + 25	33	156,00 ₺
IBH36 1300	1 x 300 + 25	33	186,00 ₺
IBH36 1400	1 x 400 + 35	33	205,00 ₺
IBH36 1500	1 x 500 + 35	33	259,00 ₺
IBH36 1630	1 x 630 + 35	33	310,00 ₺

HARİCİ





# O.G. BAKIR ÜÇ DAMARLI HARİCİ ISI BÜZÜŞMELİ KABLO BAŞLIKLARI

M.V. COPPER THREE CORES OUTDOOR HEAT SHRINKABLE CABLE TERMINATIONS



3.5-6 kV



5.8-10 kV

KOD CODE	KABLO KESİTİ CROSS SECTION	FİYAT PRICE
IBH6 325	3 x 25 + 16	465,00 ₺
IBH6 335	3 x 35 + 16	465,00 ₺
IBH6 350	3 x 50 + 16	472,00 ₺
IBH6 370	3 x 70 + 16	472,00 ₺
IBH6 395	3 x 95 + 16	479,00 ₺
IBH6 3120	3 x 120 + 16	516,00 ₺
IBH6 3150	3 x 150 + 25	516,00 ₺
IBH6 3185	3 x 185 + 25	523,00 ₺
IBH6 3240	3 x 240 + 25	523,00 ₺
IBH6 3300	3 x 300 + 25	567,00 ₺
IBH6 3400	3 x 400 + 35	573,00 ₺
IBH6 3500	3 x 500 + 35	624,00 ₺

H  
A  
R  
I  
C  
I

KOD CODE	KABLO KESİTİ CROSS SECTION	FİYAT PRICE
IBH10 325	3 x 25 + 16	465,00 ₺
IBH10 335	3 x 35 + 16	465,00 ₺
IBH10 350	3 x 50 + 16	472,00 ₺
IBH10 370	3 x 70 + 16	472,00 ₺
IBH10 395	3 x 95 + 16	479,00 ₺
IBH10 3120	3 x 120 + 16	516,00 ₺
IBH10 3150	3 x 150 + 25	516,00 ₺
IBH10 3185	3 x 185 + 25	523,00 ₺
IBH10 3240	3 x 240 + 25	523,00 ₺
IBH10 3300	3 x 300 + 25	567,00 ₺
IBH10 3400	3 x 400 + 35	573,00 ₺
IBH10 3500	3 x 500 + 35	624,00 ₺



8.7-15 kV



20.8-36 kV

KOD CODE	KABLO KESİTİ CROSS SECTION	FİYAT PRICE
IBH15 325	3 x 25 + 16	465,00 ₺
IBH15 335	3 x 35 + 16	465,00 ₺
IBH15 350	3 x 50 + 16	472,00 ₺
IBH15 370	3 x 70 + 16	472,00 ₺
IBH15 395	3 x 95 + 16	479,00 ₺
IBH15 3120	3 x 120 + 16	516,00 ₺
IBH15 3150	3 x 150 + 25	516,00 ₺
IBH15 3185	3 x 185 + 25	523,00 ₺
IBH15 3240	3 x 240 + 25	523,00 ₺
IBH15 3300	3 x 300 + 25	567,00 ₺
IBH15 3400	3 x 400 + 35	573,00 ₺
IBH15 3500	3 x 500 + 35	624,00 ₺

H  
A  
R  
I  
C  
I

KOD CODE	KABLO KESİTİ CROSS SECTION	FİYAT PRICE
IBH36 325	3 x 25 + 16	832,00 ₺
IBH36 335	3 x 35 + 16	832,00 ₺
IBH36 350	3 x 50 + 16	839,00 ₺
IBH36 370	3 x 70 + 16	839,00 ₺
IBH36 395	3 x 95 + 16	845,00 ₺
IBH36 3120	3 x 120 + 16	910,00 ₺
IBH36 3150	3 x 150 + 25	910,00 ₺
IBH36 3185	3 x 185 + 25	910,00 ₺
IBH36 3240	3 x 240 + 25	915,00 ₺
IBH36 3300	3 x 300 + 25	979,00 ₺
IBH36 3400	3 x 400 + 35	999,00 ₺
IBH36 3500	3 x 500 + 35	1.050,00 ₺





3.5-6 kV



5.8-10 kV

KOD CODE	KABLO KESİTİ CROSS SECTION	FİYAT PRICE
IBHA6 125	1X25+16	98,00 ₺
IBHA6 135	1X35+16	98,00 ₺
IBHA6 150	1X50+16	98,00 ₺
IBHA6 170	1X70+16	100,00 ₺
IBHA6 195	1X95+16	100,00 ₺
IBHA6 1120	1X120+16	102,00 ₺
IBHA6 1150	1X150+25	102,00 ₺
IBHA6 1185	1X185+25	105,00 ₺
IBHA6 1240	1X240+25	109,00 ₺
IBHA6 1300	1X300+25	137,00 ₺
IBHA6 1400	1X400+35	156,00 ₺
IBHA6 1500	1X500+35	208,00 ₺
IBHA6 1630	1X630+35	250,00 ₺

HARİCİ

KOD CODE	KABLO KESİTİ CROSS SECTION	FİYAT PRICE
IBHA10 125	1X25+16	98,00 ₺
IBHA10 135	1X35+16	98,00 ₺
IBHA10 150	1X50+16	98,00 ₺
IBHA10 170	1X70+16	100,00 ₺
IBHA10 195	1X95+16	100,00 ₺
IBHA10 1120	1X120+16	102,00 ₺
IBHA10 1150	1X150+25	102,00 ₺
IBHA10 1185	1X185+25	105,00 ₺
IBHA10 1240	1X240+25	109,00 ₺
IBHA10 1300	1X300+25	137,00 ₺
IBHA10 1400	1X400+35	156,00 ₺
IBHA10 1500	1X500+35	208,00 ₺
IBHA10 1630	1X630+35	250,00 ₺



8.7-15 kV



20.8-36 kV

KOD CODE	KABLO KESİTİ CROSS SECTION	FİYAT PRICE
IBHA15 125	1X25+16	98,00 ₺
IBHA15 135	1X35+16	98,00 ₺
IBHA15 150	1X50+16	98,00 ₺
IBHA15 170	1X70+16	100,00 ₺
IBHA15 195	1X95+16	100,00 ₺
IBHA15 1120	1X120+16	102,00 ₺
IBHA15 1150	1X150+25	102,00 ₺
IBHA15 1185	1X185+25	105,00 ₺
IBHA15 1240	1X240+25	109,00 ₺
IBHA15 1300	1X300+25	137,00 ₺
IBHA15 1400	1X400+35	156,00 ₺
IBHA15 1500	1X500+35	208,00 ₺
IBHA15 1630	1X630+35	250,00 ₺

HARİCİ

KOD CODE	KABLO KESİTİ CROSS SECTION	FİYAT PRICE
IBHA36 125	1X25+16	148,00 ₺
IBHA36 135	1X35+16	148,00 ₺
IBHA36 150	1X50+16	148,00 ₺
IBHA36 170	1X70+16	151,00 ₺
IBHA36 195	1X95+16	151,00 ₺
IBHA36 1120	1X120+16	153,00 ₺
IBHA36 1150	1X150+25	153,00 ₺
IBHA36 1185	1X185+25	155,00 ₺
IBHA36 1240	1X240+25	155,00 ₺
IBHA36 1300	1X300+25	185,00 ₺
IBHA36 1400	1X400+35	204,00 ₺
IBHA36 1500	1X500+35	258,00 ₺
IBHA36 1630	1X630+35	308,00 ₺



# O.G. ALÜMİNYUM ÜÇ DAMARLI HARİCİ ISI BÜZÜŞMELİ KABLO BAŞLIKLARI

M.V. ALUMINUM THREE CORES OUTDOOR HEAT SHRINKABLE CABLE TERMINATIONS



3.5-6 kV



5.8-10 kV

KOD CODE	KABLO KESİTİ CROSS SECTION	FİYAT PRICE
IBHA6 325	3X25+16	464,00 ₺
IBHA6 335	3X35+16	464,00 ₺
IBHA6 350	3X50+16	471,00 ₺
IBHA6 370	3X70+16	471,00 ₺
IBHA6 395	3X95+16	478,00 ₺
IBHA6 3120	3X120+16	515,00 ₺
IBHA6 3150	3X150+25	515,00 ₺
IBHA6 3185	3X185+25	522,00 ₺
IBHA6 3240	3X240+25	522,00 ₺
IBHA6 3300	3X300+25	566,00 ₺
IBHA6 3400	3X400+35	572,00 ₺
IBHA6 3500	3X500+35	622,00 ₺

H  
A  
R  
I  
C  
I

KOD CODE	KABLO KESİTİ CROSS SECTION	FİYAT PRICE
IBHA10 325	3X25+16	464,00 ₺
IBHA10 335	3X35+16	464,00 ₺
IBHA10 350	3X50+16	471,00 ₺
IBHA10 370	3X70+16	471,00 ₺
IBHA10 395	3X95+16	478,00 ₺
IBHA10 3120	3X120+16	515,00 ₺
IBHA10 3150	3X150+25	515,00 ₺
IBHA10 3185	3X185+25	522,00 ₺
IBHA10 3240	3X240+25	522,00 ₺
IBHA10 3300	3X300+25	566,00 ₺
IBHA10 3400	3X400+35	572,00 ₺
IBHA10 3500	3X500+35	622,00 ₺



8.7-15 kV



20.8-36 kV

KOD CODE	KABLO KESİTİ CROSS SECTION	FİYAT PRICE
IBHA15 325	3X25+16	464,00 ₺
IBHA15 335	3X35+16	464,00 ₺
IBHA15 350	3X50+16	471,00 ₺
IBHA15 370	3X70+16	471,00 ₺
IBHA15 395	3X95+16	478,00 ₺
IBHA15 3120	3X120+16	515,00 ₺
IBHA15 3150	3X150+25	515,00 ₺
IBHA15 3185	3X185+25	522,00 ₺
IBHA15 3240	3X240+25	522,00 ₺
IBHA15 3300	3X300+25	566,00 ₺
IBHA15 3400	3X400+35	572,00 ₺
IBHA15 3500	3X500+35	622,00 ₺

H  
A  
R  
I  
C  
I

KOD CODE	KABLO KESİTİ CROSS SECTION	FİYAT PRICE
IBHA36 325	3X25+16	831,00 ₺
IBHA36 335	3X35+16	831,00 ₺
IBHA36 350	3X50+16	838,00 ₺
IBHA36 370	3X70+16	838,00 ₺
IBHA36 395	3X95+16	844,00 ₺
IBHA36 3120	3X120+16	909,00 ₺
IBHA36 3150	3X150+25	909,00 ₺
IBHA36 3185	3X185+25	909,00 ₺
IBHA36 3240	3X240+25	914,00 ₺
IBHA36 3300	3X300+25	978,00 ₺
IBHA36 3400	3X400+35	998,00 ₺
IBHA36 3500	3X500+35	1.048,00 ₺





3.5-6 kV

KOD CODE	KABLO KESİTİ CROSS SECTION	FİYAT PRICE
MIBH6 125-195	1x25+16-1x95+16	130,00 ₺
MIBH6 1120-1240	1x120+16-1x240+25	170,00 ₺
MIBH6 1300-1400	1x300+25-1x400+35	200,00 ₺



5.8-10 kV

KOD CODE	KABLO KESİTİ CROSS SECTION	FİYAT PRICE
MIBH10 125-195	1x25+16-1x95+16	130,00 ₺
MIBH10 1120-1240	1x120+16-1x240+25	170,00 ₺
MIBH10 1300-1400	1x300+25-1x400+35	200,00 ₺

HARİCİ



8.7-15 kV

KOD CODE	KABLO KESİTİ CROSS SECTION	FİYAT PRICE
MIBH15 125-195	1x25+16-1x95+16	130,00 ₺
MIBH15 1120-1240	1x120+16-1x240+25	170,00 ₺
MIBH15 1300-1400	1x300+25-1x400+35	200,00 ₺



20.8-36 kV

KOD CODE	KABLO KESİTİ CROSS SECTION	FİYAT PRICE
MIBH36 135-195	1x25+16-1x95+16	190,00 ₺
MIBH36 1120-1240	1x120+16-1x240+25	230,00 ₺
MIBH36 1300-1400	1x300+25-1x400+35	280,00 ₺

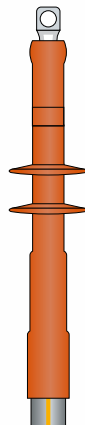

# O.G. MEKANİK ÜÇ DAMARLI HARİCİ ISI BÜZÜŞMELİ KABLO BAŞLIĞI

M.V. BOLTED THREE CORES OUTDOOR HEAT SHRINKABLE CABLE TERMINATIONS



3.5-6 kV



5.8-10 kV

KOD CODE	KABLO KESİTİ CROSS SECTION	FİYAT PRICE
MIBH6 325-395	3x25+16-3x95+16	620,00 ₺
MIBH6 3120-3240	3x120+16-3x240+25	650,00 ₺
MIBH6 3300-3400	3x300+25-3x400+35	1.050,00 ₺

KOD CODE	KABLO KESİTİ CROSS SECTION	FİYAT PRICE
MIBH10 325-395	3x25+16-3x95+16	620,00 ₺
MIBH10 3120-3240	3x120+16-3x240+25	650,00 ₺
MIBH10 3300-3400	3x300+25-3x400+35	1.050,00 ₺

H  
A  
R  
I  
C  
I



8.7-15 kV



20.8-36 kV

KOD CODE	KABLO KESİTİ CROSS SECTION	FİYAT PRICE
MIBH15 325-395	3x25+16-3x95+16	620,00 ₺
MIBH15 3120-3240	3x120+16-3x240+25	650,00 ₺
MIBH15 3300-3400	3x300+25-3x400+35	1.050,00 ₺

KOD CODE	KABLO KESİTİ CROSS SECTION	FİYAT PRICE
MIBH36 335-395	3x25+16-3x95+16	850,00 ₺
MIBH36 3120-3240	3x120+16-3x240+25	900,00 ₺
MIBH36 3300-3400	3x300+25-3x400+35	1.200,00 ₺





3.5-6 kV



5.8-10 kV

KOD CODE	KABLO KESİTİ CROSS SECTION	KOLİ ADETİ UNIT / BOX	FİYAT PRICE
IBD6 125	1 x 25 + 16	33	71,00 ₺
IBD6 135	1 x 35 + 16	33	71,00 ₺
IBD6 150	1 x 50 + 16	33	71,00 ₺
IBD6 170	1 x 70 + 16	33	73,00 ₺
IBD6 195	1 x 95 + 16	33	73,00 ₺
IBD6 1120	1 x 120 + 16	33	76,00 ₺
IBD6 1150	1 x 150 + 25	33	76,00 ₺
IBD6 1185	1 x 185 + 25	33	78,00 ₺
IBD6 1240	1 x 240 + 25	33	83,00 ₺
IBD6 1300	1 x 300 + 25	33	103,00 ₺
IBD6 1400	1 x 400 + 35	33	124,00 ₺
IBD6 1500	1 x 500 + 35	33	176,00 ₺
IBD6 1630	1 x 630 + 35	33	217,00 ₺

DAHİLİ

KOD CODE	KABLO KESİTİ CROSS SECTION	KOLİ ADETİ UNIT / BOX	FİYAT PRICE
IBD10 125	1 x 25 + 16	33	71,00 ₺
IBD10 135	1 x 35 + 16	33	71,00 ₺
IBD10 150	1 x 50 + 16	33	71,00 ₺
IBD10 170	1 x 70 + 16	33	73,00 ₺
IBD10 195	1 x 95 + 16	33	73,00 ₺
IBD10 1120	1 x 120 + 16	33	76,00 ₺
IBD10 1150	1 x 150 + 25	33	76,00 ₺
IBD10 1185	1 x 185 + 25	33	78,00 ₺
IBD10 1240	1 x 240 + 25	33	83,00 ₺
IBD10 1300	1 x 300 + 25	33	103,00 ₺
IBD10 1400	1 x 400 + 35	33	124,00 ₺
IBD10 1500	1 x 500 + 35	33	176,00 ₺
IBD10 1630	1 x 630 + 35	33	217,00 ₺



8.7-15 kV



20.8-36 kV

KOD CODE	KABLO KESİTİ CROSS SECTION	KOLİ ADETİ UNIT / BOX	FİYAT PRICE
IBD15 125	1 x 25 + 16	33	71,00 ₺
IBD15 135	1 x 35 + 16	33	71,00 ₺
IBD15 150	1 x 50 + 16	33	71,00 ₺
IBD15 170	1 x 70 + 16	33	73,00 ₺
IBD15 195	1 x 95 + 16	33	73,00 ₺
IBD15 1120	1 x 120 + 16	33	76,00 ₺
IBD15 1150	1 x 150 + 25	33	76,00 ₺
IBD15 1185	1 x 185 + 25	33	78,00 ₺
IBD15 1240	1 x 240 + 25	33	83,00 ₺
IBD15 1300	1 x 300 + 25	33	103,00 ₺
IBD15 1400	1 x 400 + 35	33	124,00 ₺
IBD15 1500	1 x 500 + 35	33	176,00 ₺
IBD15 1630	1 x 630 + 35	33	217,00 ₺

DAHİLİ

KOD CODE	KABLO KESİTİ CROSS SECTION	KOLİ ADETİ UNIT / BOX	FİYAT PRICE
IBD36 125	1 x 25 + 16	33	99,00 ₺
IBD36 135	1 x 35 + 16	33	99,00 ₺
IBD36 150	1 x 50 + 16	33	99,00 ₺
IBD36 170	1 x 70 + 16	33	101,00 ₺
IBD36 195	1 x 95 + 16	33	101,00 ₺
IBD36 1120	1 x 120 + 16	33	103,00 ₺
IBD36 1150	1 x 150 + 25	33	103,00 ₺
IBD36 1185	1 x 185 + 25	33	106,00 ₺
IBD36 1240	1 x 240 + 25	33	110,00 ₺
IBD36 1300	1 x 300 + 25	33	149,00 ₺
IBD36 1400	1 x 400 + 35	33	169,00 ₺
IBD36 1500	1 x 500 + 35	33	222,00 ₺
IBD36 1630	1 x 630 + 35	33	268,00 ₺



# O.G. BAKIR ÜÇ DAMARLI DAHİLİ ISI BÜZÜŞMELİ KABLO BAŞLIKLARI

M.V. COPPER THREE CORES INDOOR HEAT SHRINKABLE CABLE TERMINATIONS



3.5-6 kV



5.8-10 kV

KOD CODE	KABLO KESİTİ CROSS SECTION	FİYAT PRICE
IBD6 325	3 x 25 + 16	364,00 ₺
IBD6 335	3 x 35 + 16	364,00 ₺
IBD6 350	3 x 50 + 16	371,00 ₺
IBD6 370	3 x 70 + 16	371,00 ₺
IBD6 395	3 x 95 + 16	378,00 ₺
IBD6 3120	3 x 120 + 16	414,00 ₺
IBD6 3150	3 x 150 + 25	414,00 ₺
IBD6 3185	3 x 185 + 25	421,00 ₺
IBD6 3240	3 x 240 + 25	421,00 ₺
IBD6 3300	3 x 300 + 25	449,00 ₺
IBD6 3400	3 x 400 + 35	469,00 ₺
IBD6 3500	3 x 500 + 35	521,00 ₺

DAHİLİ

KOD CODE	KABLO KESİTİ CROSS SECTION	FİYAT PRICE
IBD10 325	3 x 25 + 16	364,00 ₺
IBD10 335	3 x 35 + 16	364,00 ₺
IBD10 350	3 x 50 + 16	371,00 ₺
IBD10 370	3 x 70 + 16	371,00 ₺
IBD10 395	3 x 95 + 16	378,00 ₺
IBD10 3120	3 x 120 + 16	414,00 ₺
IBD10 3150	3 x 150 + 25	414,00 ₺
IBD10 3185	3 x 185 + 25	421,00 ₺
IBD10 3240	3 x 240 + 25	421,00 ₺
IBD10 3300	3 x 300 + 25	449,00 ₺
IBD10 3400	3 x 400 + 35	469,00 ₺
IBD10 3500	3 x 500 + 35	521,00 ₺



8.7-15 kV

20.8-36 kV

KOD CODE	KABLO KESİTİ CROSS SECTION	FİYAT PRICE
IBD15 325	3 x 25 + 16	364,00 ₺
IBD15 335	3 x 35 + 16	364,00 ₺
IBD15 350	3 x 50 + 16	371,00 ₺
IBD15 370	3 x 70 + 16	371,00 ₺
IBD15 395	3 x 95 + 16	378,00 ₺
IBD15 3120	3 x 120 + 16	414,00 ₺
IBD15 3150	3 x 150 + 25	414,00 ₺
IBD15 3185	3 x 185 + 25	421,00 ₺
IBD15 3240	3 x 240 + 25	421,00 ₺
IBD15 3300	3 x 300 + 25	449,00 ₺
IBD15 3400	3 x 400 + 35	469,00 ₺
IBD15 3500	3 x 500 + 35	521,00 ₺

DAHİLİ

KOD CODE	KABLO KESİTİ CROSS SECTION	FİYAT PRICE
IBD36 325	3 x 25 + 16	567,00 ₺
IBD36 335	3 x 35 + 16	567,00 ₺
IBD36 350	3 x 50 + 16	574,00 ₺
IBD36 370	3 x 70 + 16	575,00 ₺
IBD36 395	3 x 95 + 16	580,00 ₺
IBD36 3120	3 x 120 + 16	631,00 ₺
IBD36 3150	3 x 150 + 25	631,00 ₺
IBD36 3185	3 x 185 + 25	638,00 ₺
IBD36 3240	3 x 240 + 25	638,00 ₺
IBD36 3300	3 x 300 + 25	698,00 ₺
IBD36 3400	3 x 400 + 35	717,00 ₺
IBD36 3500	3 x 500 + 35	769,00 ₺





3.5-6 kV



5.8-10 kV

KOD CODE	KABLO KESİTİ CROSS SECTION	KOLİ ADETİ UNIT / BOX	FİYAT PRICE
IBDA6 125	1 x 25 + 16	33	70,00 ₺
IBDA6 135	1 x 35 + 16	33	70,00 ₺
IBDA6 150	1 x 50 + 16	33	70,00 ₺
IBDA6 170	1 x 70 + 16	33	72,00 ₺
IBDA6 195	1 x 95 + 16	33	72,00 ₺
IBDA6 1120	1 x 120 + 16	33	75,00 ₺
IBDA6 1150	1 x 150 + 25	33	75,00 ₺
IBDA6 1185	1 x 185 + 25	33	77,00 ₺
IBDA6 1240	1 x 240 + 25	33	82,00 ₺
IBDA6 1300	1 x 300 + 25	33	102,00 ₺
IBDA6 1400	1 x 400 + 35	33	123,00 ₺
IBDA6 1500	1 x 500 + 35	33	175,00 ₺
IBDA6 1630	1 x 630 + 35	33	216,00 ₺

DAHİLİ

KOD CODE	KABLO KESİTİ CROSS SECTION	KOLİ ADETİ UNIT / BOX	FİYAT PRICE
IBDA10 125	1 x 25 + 16	33	70,00 ₺
IBDA10 135	1 x 35 + 16	33	70,00 ₺
IBDA10 150	1 x 50 + 16	33	70,00 ₺
IBDA10 170	1 x 70 + 16	33	72,00 ₺
IBDA10 195	1 x 95 + 16	33	72,00 ₺
IBDA10 1120	1 x 120 + 16	33	75,00 ₺
IBDA10 1150	1 x 150 + 25	33	75,00 ₺
IBDA10 1185	1 x 185 + 25	33	77,00 ₺
IBDA10 1240	1 x 240 + 25	33	82,00 ₺
IBDA10 1300	1 x 300 + 25	33	102,00 ₺
IBDA10 1400	1 x 400 + 35	33	123,00 ₺
IBDA10 1500	1 x 500 + 35	33	175,00 ₺
IBDA10 1630	1 x 630 + 35	33	216,00 ₺



8.7-15 kV



20.8-36 kV

KOD CODE	KABLO KESİTİ CROSS SECTION	KOLİ ADETİ UNIT / BOX	FİYAT PRICE
IBDA15 125	1 x 25 + 16	33	70,00 ₺
IBDA15 135	1 x 35 + 16	33	70,00 ₺
IBDA15 150	1 x 50 + 16	33	70,00 ₺
IBDA15 170	1 x 70 + 16	33	72,00 ₺
IBDA15 195	1 x 95 + 16	33	72,00 ₺
IBDA15 1120	1 x 120 + 16	33	75,00 ₺
IBDA15 1150	1 x 150 + 25	33	75,00 ₺
IBDA15 1185	1 x 185 + 25	33	77,00 ₺
IBDA15 1240	1 x 240 + 25	33	82,00 ₺
IBDA15 1300	1 x 300 + 25	33	102,00 ₺
IBDA15 1400	1 x 400 + 35	33	123,00 ₺
IBDA15 1500	1 x 500 + 35	33	175,00 ₺
IBDA15 1630	1 x 630 + 35	33	216,00 ₺

DAHİLİ

KOD CODE	KABLO KESİTİ CROSS SECTION	KOLİ ADETİ UNIT / BOX	FİYAT PRICE
IBDA36 125	1 x 25 + 16	33	98,00 ₺
IBDA36 135	1 x 35 + 16	33	98,00 ₺
IBDA36 150	1 x 50 + 16	33	98,00 ₺
IBDA36 170	1 x 70 + 16	33	100,00 ₺
IBDA36 195	1 x 95 + 16	33	100,00 ₺
IBDA36 1120	1 x 120 + 16	33	102,00 ₺
IBDA36 1150	1 x 150 + 25	33	102,00 ₺
IBDA36 1185	1 x 185 + 25	33	105,00 ₺
IBDA36 1240	1 x 240 + 25	33	109,00 ₺
IBDA36 1300	1 x 300 + 25	33	148,00 ₺
IBDA36 1400	1 x 400 + 35	33	168,00 ₺
IBDA36 1500	1 x 500 + 35	33	221,00 ₺
IBDA36 1630	1 x 630 + 35	33	267,00 ₺





# O.G. ALÜMİNYUM ÜÇ DAMARLI DAHİLİ ISI BÜZÜŞMELİ KABLO BAŞLIKLARI

M.V. ALUMINUM THREE CORES INDOOR HEAT SHRINKABLE CABLE TERMINATIONS



3.5-6 kV



5.8-10 kV

KOD CODE	KABLO KESİTİ CROSS SECTION	FİYAT PRICE
IBDA6 325	3 x 25 + 16	363,00 ₺
IBDA6 335	3 x 35 + 16	363,00 ₺
IBDA6 350	3 x 50 + 16	370,00 ₺
IBDA6 370	3 x 70 + 16	370,00 ₺
IBDA6 395	3 x 95 + 16	377,00 ₺
IBDA6 3120	3 x 120 + 16	413,00 ₺
IBDA6 3150	3 x 150 + 25	413,00 ₺
IBDA6 3185	3 x 185 + 25	420,00 ₺
IBDA6 3240	3 x 240 + 25	420,00 ₺
IBDA6 3300	3 x 300 + 25	448,00 ₺
IBDA6 3400	3 x 400 + 35	468,00 ₺
IBDA6 3500	3 x 500 + 35	519,00 ₺

DAHİLİ

KOD CODE	KABLO KESİTİ CROSS SECTION	FİYAT PRICE
IBDA10 325	3 x 25 + 16	363,00 ₺
IBDA10 335	3 x 35 + 16	363,00 ₺
IBDA10 350	3 x 50 + 16	370,00 ₺
IBDA10 370	3 x 70 + 16	370,00 ₺
IBDA10 395	3 x 95 + 16	377,00 ₺
IBDA10 3120	3 x 120 + 16	413,00 ₺
IBDA10 3150	3 x 150 + 25	413,00 ₺
IBDA10 3185	3 x 185 + 25	420,00 ₺
IBDA10 3240	3 x 240 + 25	420,00 ₺
IBDA10 3300	3 x 300 + 25	448,00 ₺
IBDA10 3400	3 x 400 + 35	468,00 ₺
IBDA10 3500	3 x 500 + 35	519,00 ₺



8.7-15 kV

20.8-36 kV

KOD CODE	KABLO KESİTİ CROSS SECTION	FİYAT PRICE
IBDA15 325	3 x 25 + 16	363,00 ₺
IBDA15 335	3 x 35 + 16	363,00 ₺
IBDA15 350	3 x 50 + 16	370,00 ₺
IBDA15 370	3 x 70 + 16	370,00 ₺
IBDA15 395	3 x 95 + 16	377,00 ₺
IBDA15 3120	3 x 120 + 16	413,00 ₺
IBDA15 3150	3 x 150 + 25	413,00 ₺
IBDA15 3185	3 x 185 + 25	420,00 ₺
IBDA15 3240	3 x 240 + 25	420,00 ₺
IBDA15 3300	3 x 300 + 25	448,00 ₺
IBDA15 3400	3 x 400 + 35	468,00 ₺
IBDA15 3500	3 x 500 + 35	519,00 ₺

DAHİLİ

KOD CODE	KABLO KESİTİ CROSS SECTION	FİYAT PRICE
IBDA36 325	3 x 25 + 16	566,00 ₺
IBDA36 335	3 x 35 + 16	566,00 ₺
IBDA36 350	3 x 50 + 16	573,00 ₺
IBDA36 370	3 x 70 + 16	574,00 ₺
IBDA36 395	3 x 95 + 16	579,00 ₺
IBDA36 3120	3 x 120 + 16	630,00 ₺
IBDA36 3150	3 x 150 + 25	630,00 ₺
IBDA36 3185	3 x 185 + 25	637,00 ₺
IBDA36 3240	3 x 240 + 25	637,00 ₺
IBDA36 3300	3 x 300 + 25	697,00 ₺
IBDA36 3400	3 x 400 + 35	716,00 ₺
IBDA36 3500	3 x 500 + 35	767,00 ₺





3.5-6 kV



5.8-10 kV

KOD CODE	KABLO KESİTİ CROSS SECTION	FİYAT PRICE
MMIBD6 125-195	1x25+16 - 1x95+16	110,00 ₺
MIBD6 1120-1240	1x120+16 - 1x240+25	140,00 ₺
MIBD6 1300-1400	1x300+25 - 1x400+35	180,00 ₺

KOD CODE	KABLO KESİTİ CROSS SECTION	FİYAT PRICE
MIBD10 125-195	1x25+16 - 1x95+16	110,00 ₺
MIBD10 1120-1240	1x120+16 - 1x240+25	140,00 ₺
MIBD10 1300-1400	1x300+25 - 1x400+35	180,00 ₺

DAHİLİ



8.7-15 kV



20.8-36 kV

KOD CODE	KABLO KESİTİ CROSS SECTION	FİYAT PRICE
MIBD15 125-195	1x25+16 - 1x95+16	110,00 ₺
MIBD15 1120-1240	1x120+16 - 1x240+25	140,00 ₺
MIBD15 1300-1400	1x300+25 - 1x400+35	180,00 ₺

KOD CODE	KABLO KESİTİ CROSS SECTION	FİYAT PRICE
MIBD36 135-195	1x35+16 - 1x95+16	140,00 ₺
MIBD36 1120-1240	1x120+16 - 1x240+25	170,00 ₺
MIBD36 1300-1400	1x300+25 - 1x400+35	240,00 ₺

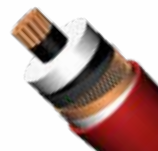
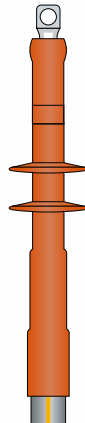

# O.G. MEKANİK ÜÇ DAMARLI DAHİLİ ISI BÜZÜŞMELİ KABLO BAŞLIKLARI

M.V. BOLTED THREE CORES INDOOR HEAT SHRINKABLE CABLE TERMINATIONS



3.5-6 kV



5.8-10 kV

KOD CODE	KABLO KESİTİ CROSS SECTION	FİYAT PRICE
MIBD6 325-395	3x25+16 - 3x95+16	450,00 ₺
MIBD6 3120-3240	3x120+16 - 3x240+25	500,00 ₺
MIBD6 3300-3400	3x300+25 - 3x400+35	850,00 ₺

KOD CODE	KABLO KESİTİ CROSS SECTION	FİYAT PRICE
MIBD10 325-395	3x25+16 - 3x95+16	450,00 ₺
MIBD10 3120-3240	3x120+16 - 3x240+25	500,00 ₺
MIBD10 3300-3400	3x300+25 - 3x400+35	850,00 ₺

DAHİLİ



8.7-15 kV



20.8-36 kV

KOD CODE	KABLO KESİTİ CROSS SECTION	FİYAT PRICE
MIBD15 325-395	3x25+16-3x95+16	450,00 ₺
MIBD15 3120-3240	3x120+16-3x240+25	500,00 ₺
MIBD15 3300-3400	3x300+25-3x400+35	850,00 ₺

KOD CODE	KABLO KESİTİ CROSS SECTION	FİYAT PRICE
MIBD36 335-395	3x25+16 - 3x95+16	640,00 ₺
MIBD36 3120-3240	3x120+16 - 3x240+25	690,00 ₺
MIBD36 3300-3400	3x300+25 - 3x400+35	1.000,00 ₺

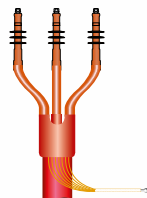



OG Silikon  
Kablo Bařlıklarında  
**Hızlı Montaj**  
**Hızlı Çözüm**

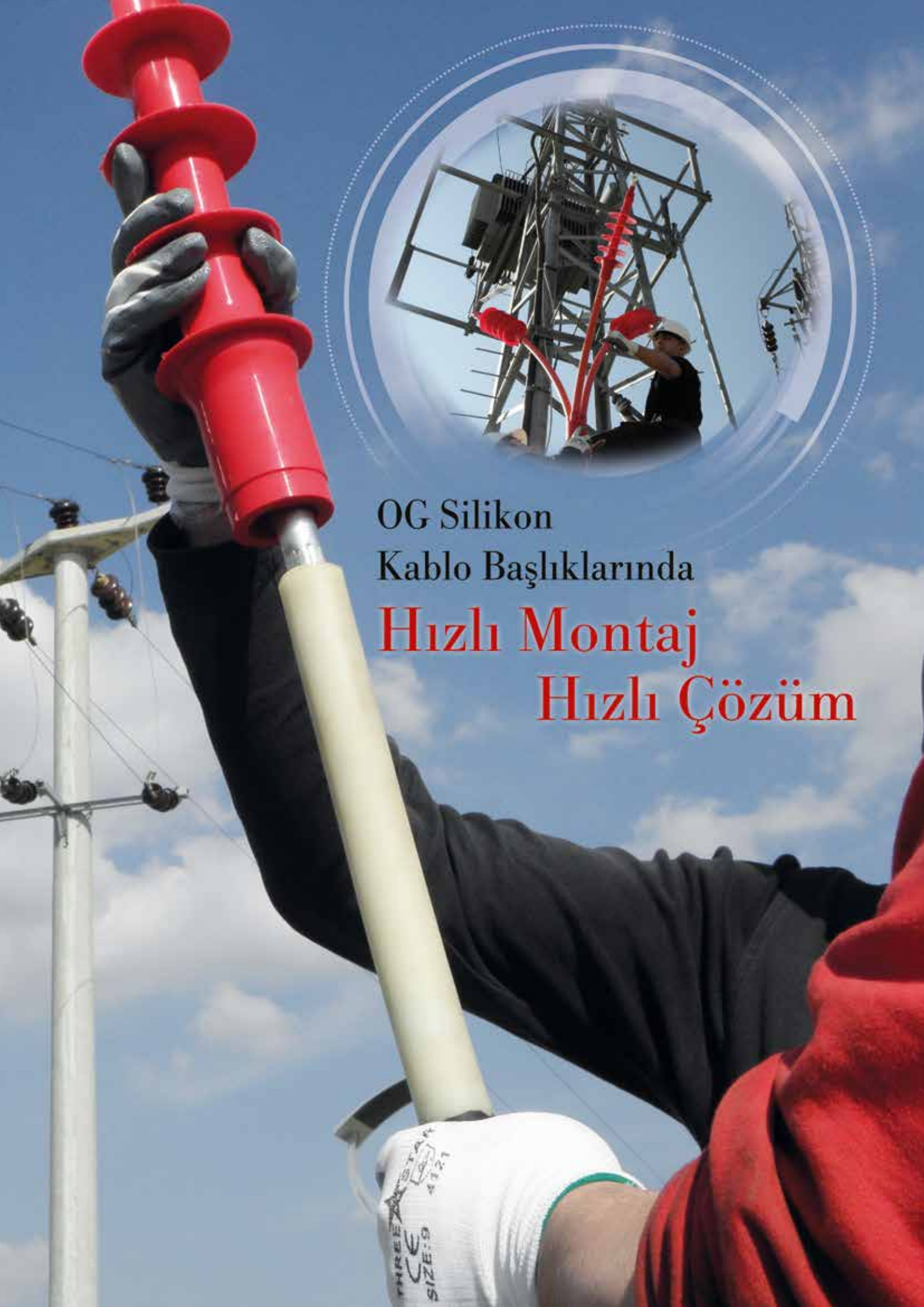

# O.G. TESLA MODELİ (YEKPARE) SİLİKON KABLO BAŞLIKLARI

M.V. TESLA TYPE SILICONE CABLE TERMINATIONS

## TEK DAMARLI HARİCİ KABLO BAŞLIĞI SINGLE CORE OUTDOOR CABLE TERMINATIONS



20.8-36 kV

20.8-36 kV

## ÜÇ DAMARLI HARİCİ KABLO BAŞLIĞI THREE CORES OUTDOOR CABLE TERMINATIONS



KOD CODE	KABLO KESİTİ CROSS SECTION	FİYAT PRICE
TSH36 135	1 x 35 + 16	238,00 ₺
TSH36 150	1 x 50 + 16	238,00 ₺
TSH36 170	1 x 70 + 16	238,00 ₺
TSH36 195	1 x 95 + 16	238,00 ₺
TSH36 1120	1 x 120 + 16	275,00 ₺
TSH36 1150	1 x 150 + 25	275,00 ₺
TSH36 1185	1 x 185 + 25	275,00 ₺
TSH36 1240	1 x 240 + 25	275,00 ₺

H  
A  
R  
İ  
C  
İ

KOD CODE	KABLO KESİTİ CROSS SECTION	FİYAT PRICE
TSH36 335	3 x 35 + 16	764,00 ₺
TSH36 350	3 x 50 + 16	764,00 ₺
TSH36 370	3 x 70 + 16	764,00 ₺
TSH36 395	3 x 95 + 16	764,00 ₺
TSH36 3120	3 x 120 + 16	854,00 ₺
TSH36 3150	3 x 150 + 25	854,00 ₺
TSH36 3185	3 x 185 + 25	854,00 ₺
TSH36 3240	3 x 240 + 25	854,00 ₺

## TEK DAMARLI DAHİLİ KABLO BAŞLIĞI SINGLE CORE INDOOR CABLE TERMINATIONS



20.8-36 kV

20.8-36 kV

## ÜÇ DAMARLI DAHİLİ KABLO BAŞLIĞI THREE CORES INDOOR CABLE TERMINATIONS



KOD CODE	KABLO KESİTİ CROSS SECTION	FİYAT PRICE
TSD36 135	1 x 35 + 16	171,00 ₺
TSD36 150	1 x 50 + 16	171,00 ₺
TSD36 170	1 x 70 + 16	171,00 ₺
TSD36 195	1 x 95 + 16	171,00 ₺
TSD36 1120	1 x 120 + 16	214,00 ₺
TSD36 1150	1 x 150 + 25	214,00 ₺
TSD36 1185	1 x 185 + 25	214,00 ₺
TSD36 1240	1 x 240 + 25	214,00 ₺

D  
A  
H  
İ  
L  
İ

KOD CODE	KABLO KESİTİ CROSS SECTION	FİYAT PRICE
TSD36 335	3 x 35 + 16	640,00 ₺
TSD36 350	3 x 50 + 16	640,00 ₺
TSD36 370	3 x 70 + 16	640,00 ₺
TSD36 395	3 x 95 + 16	640,00 ₺
TSD36 3120	3 x 120 + 16	680,00 ₺
TSD36 3150	3 x 150 + 25	680,00 ₺
TSD36 3185	3 x 185 + 25	680,00 ₺
TSD36 3240	3 x 240 + 25	680,00 ₺





KOD CODE	KABLO KESİTİ CROSS SECTION	FİYAT PRICE
SH6 125	1 x 25 +16	78,00 ₺
SH6 135	1 x 35 +16	78,00 ₺
SH6 150	1 x 50 +16	78,00 ₺
SH6 170	1 x 70 +16	83,00 ₺
SH6 195	1 x 95 +16	83,00 ₺
SH6 1120	1 x 120 +16	88,00 ₺
SH6 1150	1 x 150 +25	88,00 ₺
SH6 1185	1 x 185 +25	93,00 ₺
SH6 1240	1 x 240 +25	100,00 ₺



KOD CODE	KABLO KESİTİ CROSS SECTION	FİYAT PRICE
SH10 125	1 x 25 + 16	78,00 ₺
SH10 135	1 x 35 + 16	78,00 ₺
SH10 150	1 x 50 + 16	78,00 ₺
SH10 170	1 x 70 + 16	83,00 ₺
SH10 195	1 x 95 + 16	83,00 ₺
SH10 1120	1 x 120 + 16	88,00 ₺
SH10 1150	1 x 150 + 25	88,00 ₺
SH10 1185	1 x 185 + 25	93,00 ₺
SH10 1240	1 x 240 + 25	100,00 ₺

HARİCİ



KOD CODE	KABLO KESİTİ CROSS SECTION	FİYAT PRICE
SH15 125	1 x 25 + 16	93,00 ₺
SH15 135	1 x 35 + 16	93,00 ₺
SH15 150	1 x 50 + 16	93,00 ₺
SH15 170	1 x 70 + 16	98,00 ₺
SH15 195	1 x 95 + 16	98,00 ₺
SH15 1120	1 x 120 + 16	105,00 ₺
SH15 1150	1 x 150 + 25	105,00 ₺
SH15 1185	1 x 185 + 25	115,00 ₺
SH15 1240	1 x 240 + 25	117,00 ₺



KOD CODE	KABLO KESİTİ CROSS SECTION	FİYAT PRICE
SH36 125	1 x 25 + 16	144,00 ₺
SH36 135	1 x 35 + 16	144,00 ₺
SH36 150	1 x 50 + 16	155,00 ₺
SH36 170	1 x 70 + 16	155,00 ₺
SH36 195	1 x 95 + 16	174,00 ₺
SH36 1120	1 x 120 + 16	174,00 ₺
SH36 1150	1 x 150 + 25	181,00 ₺
SH36 1185	1 x 185 + 25	181,00 ₺
SH36 1240	1 x 240 + 25	205,00 ₺

HARİCİ

\* Alüminyum iletkenli üretim yapılıdır.  
\* Production of aluminium conductors are made



# O.G. ÜÇ DAMARLI HARİCİ SİLİKON KABLO BAŞLIKLARI

M.V. THREE CORES OUTDOOR SILICONE CABLE TERMINATIONS



3.5-6 kV



5.8-10 kV

KOD CODE	KABLO KESİTİ CROSS SECTION	FİYAT PRICE
SH6 325	3 x 25 + 16	224,00 ₺
SH6 335	3 x 35 + 16	224,00 ₺
SH6 350	3 x 50 + 16	224,00 ₺
SH6 370	3 x 70 + 16	229,00 ₺
SH6 395	3 x 95 + 16	229,00 ₺
SH6 3120	3 x 120 + 16	234,00 ₺
SH6 3150	3 x 150 + 25	234,00 ₺
SH6 3185	3 x 185 + 25	239,00 ₺
SH6 3240	3 x 240 + 25	246,00 ₺

HARİCİ

KOD CODE	KABLO KESİTİ CROSS SECTION	FİYAT PRICE
SH10 325	3 x 25 + 16	224,00 ₺
SH10 335	3 x 35 + 16	224,00 ₺
SH10 350	3 x 50 + 16	224,00 ₺
SH10 370	3 x 70 + 16	229,00 ₺
SH10 395	3 x 95 + 16	229,00 ₺
SH10 3120	3 x 120 + 16	234,00 ₺
SH10 3150	3 x 150 + 25	234,00 ₺
SH10 3185	3 x 185 + 25	239,00 ₺
SH10 3240	3 x 240 + 25	246,00 ₺



8.7-15 kV



20.8-36 kV

KOD CODE	KABLO KESİTİ CROSS SECTION	FİYAT PRICE
SH15 325	3 x 25 + 16	263,00 ₺
SH15 335	3 x 35 + 16	263,00 ₺
SH15 350	3 x 50 + 16	263,00 ₺
SH15 370	3 x 70 + 16	270,00 ₺
SH15 395	3 x 95 + 16	270,00 ₺
SH15 3120	3 x 120 + 16	275,00 ₺
SH15 3150	3 x 150 + 25	275,00 ₺
SH15 3185	3 x 185 + 25	279,00 ₺
SH15 3240	3 x 240 + 25	287,00 ₺

HARİCİ

KOD CODE	KABLO KESİTİ CROSS SECTION	FİYAT PRICE
SH36 325	3 x 25 + 16	454,00 ₺
SH36 335	3 x 35 + 16	454,00 ₺
SH36 350	3 x 50 + 16	485,00 ₺
SH36 370	3 x 70 + 16	485,00 ₺
SH36 395	3 x 95 + 16	533,00 ₺
SH36 3120	3 x 120 + 16	533,00 ₺
SH36 3150	3 x 150 + 25	540,00 ₺
SH36 3185	3 x 185 + 25	540,00 ₺
SH36 3240	3 x 240 + 25	610,00 ₺





3.5-6 kV

KOD CODE	KABLO KESİTİ CROSS SECTION	FİYAT PRICE
SD6 125	1 x 25 + 16	57,00 ₺
SD6 135	1 x 35 + 16	57,00 ₺
SD6 150	1 x 50 + 16	57,00 ₺
SD6 170	1 x 70 + 16	59,00 ₺
SD6 195	1 x 95 + 16	59,00 ₺
SD6 1120	1 x 120 + 16	64,00 ₺
SD6 1150	1 x 150 + 25	64,00 ₺
SD6 1185	1 x 185 + 25	69,00 ₺
SD6 1240	1 x 240 + 25	76,00 ₺



5.8-10 kV

KOD CODE	KABLO KESİTİ CROSS SECTION	FİYAT PRICE
SD10 125	1 x 25 + 16	57,00 ₺
SD10 135	1 x 35 + 16	57,00 ₺
SD10 150	1 x 50 + 16	57,00 ₺
SD10 170	1 x 70 + 16	59,00 ₺
SD10 195	1 x 95 + 16	59,00 ₺
SD10 1120	1 x 120 + 16	64,00 ₺
SD10 1150	1 x 150 + 25	64,00 ₺
SD10 1185	1 x 185 + 25	69,00 ₺
SD10 1240	1 x 240 + 25	76,00 ₺

DAHİLİ



8.7-15 kV

KOD CODE	KABLO KESİTİ CROSS SECTION	FİYAT PRICE
SD15 125	1 x 25 + 16	62,00 ₺
SD15 135	1 x 35 + 16	62,00 ₺
SD15 150	1 x 50 + 16	62,00 ₺
SD15 170	1 x 70 + 16	64,00 ₺
SD15 195	1 x 95 + 16	64,00 ₺
SD15 1120	1 x 120 + 16	69,00 ₺
SD15 1150	1 x 150 + 25	69,00 ₺
SD15 1185	1 x 185 + 25	74,00 ₺
SD15 1240	1 x 240 + 25	88,00 ₺



20.8-36 kV

KOD CODE	KABLO KESİTİ CROSS SECTION	FİYAT PRICE
SD36 125	1 x 25 + 16	79,00 ₺
SD36 135	1 x 35 + 16	79,00 ₺
SD36 150	1 x 50 + 16	83,00 ₺
SD36 170	1 x 70 + 16	83,00 ₺
SD36 195	1 x 95 + 16	94,00 ₺
SD36 1120	1 x 120 + 16	94,00 ₺
SD36 1150	1 x 150 + 25	103,00 ₺
SD36 1185	1 x 185 + 25	103,00 ₺
SD36 1240	1 x 240 + 25	124,00 ₺

DAHİLİ





# O.G. ÜÇ DAMARLI DAHİLİ SİLİKON KABLO BAŞLIKLARI

M.V. THREE CORES INDOOR SILICONE CABLE TERMINATIONS



3.5-6 kV



5.8-10 kV

KOD CODE	KABLO KESİTİ CROSS SECTION	FİYAT PRICE
SD6 325	3 x 25 + 16	131,00 ₺
SD6 335	3 x 35 + 16	131,00 ₺
SD6 350	3 x 50 + 16	131,00 ₺
SD6 370	3 x 70 + 16	141,00 ₺
SD6 395	3 x 95 + 16	141,00 ₺
SD6 3120	3 x 120 + 16	146,00 ₺
SD6 3150	3 x 150 + 25	146,00 ₺
SD6 3185	3 x 185 + 25	150,00 ₺
SD6 3240	3 x 240 + 25	157,00 ₺

DAHİLİ

KOD CODE	KABLO KESİTİ CROSS SECTION	FİYAT PRICE
SD10 325	3 x 25 + 16	131,00 ₺
SD10 335	3 x 35 + 16	131,00 ₺
SD10 350	3 x 50 + 16	131,00 ₺
SD10 370	3 x 70 + 16	141,00 ₺
SD10 395	3 x 95 + 16	141,00 ₺
SD10 3120	3 x 120 + 16	146,00 ₺
SD10 3150	3 x 150 + 25	146,00 ₺
SD10 3185	3 x 185 + 25	150,00 ₺
SD10 3240	3 x 240 + 25	157,00 ₺



8.7-15 kV



20.8-36 kV

KOD CODE	KABLO KESİTİ CROSS SECTION	FİYAT PRICE
SD15 325	3 x 25 + 16	179,00 ₺
SD15 335	3 x 35 + 16	179,00 ₺
SD15 350	3 x 50 + 16	179,00 ₺
SD15 370	3 x 70 + 16	189,00 ₺
SD15 395	3 x 95 + 16	189,00 ₺
SD15 3120	3 x 120 + 16	193,00 ₺
SD15 3150	3 x 150 + 25	193,00 ₺
SD15 3185	3 x 185 + 25	198,00 ₺
SD15 3240	3 x 240 + 25	205,00 ₺

DAHİLİ

KOD CODE	KABLO KESİTİ CROSS SECTION	FİYAT PRICE
SD36 325	3 x 25 + 16	296,00 ₺
SD36 335	3 x 35 + 16	296,00 ₺
SD36 350	3 x 50 + 16	301,00 ₺
SD36 370	3 x 70 + 16	301,00 ₺
SD36 395	3 x 95 + 16	330,00 ₺
SD36 3120	3 x 120 + 16	330,00 ₺
SD36 3150	3 x 150 + 25	339,00 ₺
SD36 3185	3 x 185 + 25	339,00 ₺
SD36 3240	3 x 240 + 25	389,00 ₺



### SIKMALI KABLO PABUÇLARI COMPRESSIVE CABLE LUGS

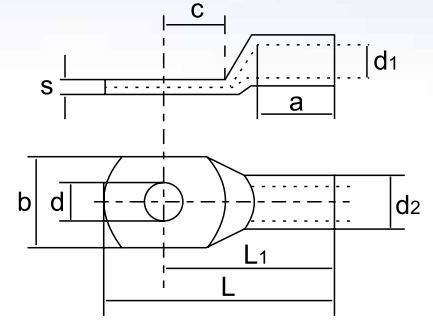

KOD CODE	KESİT CROSS SECTION	BAĞLANTI SCREW DIAMETER	KUTU / ADET UNIT / BOX	FİYAT PRICE	a (mm)	b (mm)	c (mm)	d (mm)	d1 (mm)	d2 (mm)	L (mm)	L1 (mm)	s (mm)
SKP 06	6 mm <sup>2</sup>	M 6	1500	1,15 ₺	7,5	7,8	6,7	5,4	4,1	5,45	25,1	18,55	1,55
SKP 10	10 mm <sup>2</sup>	M 6	1000	1,38 ₺	15	8,9	7,24	5,6	4,57	5,9	36,2	29,5	1,3
SKP 16	16 mm <sup>2</sup>	M 6	400	1,75 ₺	20	12,9	13	8,6	6,5	8,55	51	44,2	1,8
SKP 25	25 mm <sup>2</sup>	M 8	250	2,40 ₺	25	14,2	12	8,55	7	10	53,5	42,6	2,95
SKP 35	35 mm <sup>2</sup>	M 10	200	3,45 ₺	25	17,1	10,5	10,5	8,8	11,48	58	46,7	2,38
SKP 50	50 mm <sup>2</sup>	M 10	150	5,20 ₺	25	18,7	12,9	10,6	10,1	13	63,4	53,4	2,8
SKP 70	70 mm <sup>2</sup>	M 12	100	6,35 ₺	27,8	21	12,71	13,5	11,7	14,48	71,2	55	2,88
SKP 95	95 mm <sup>2</sup>	M 12	75	8,30 ₺	34	24,8	15,2	13,5	13,49	17,25	82,5	66	3,34
SKP 120	120 mm <sup>2</sup>	M 12	50	11,10 ₺	33	26	15	13	14,35	18,14	83,7	67,8	3,46
SKP 150	150 mm <sup>2</sup>	M 12	35	14,95 ₺	35	32	12,8	13	17,7	21,85	92,7	76,7	3,77
SKP 185	185 mm <sup>2</sup>	M 16	25	16,50 ₺	39	33,6	16,7	17	18	23,1	99,3	80,1	3,8
SKP 240	240 mm <sup>2</sup>	M 16	18	26,00 ₺	40	39,1	16,1	17	21,2	27	108	89	5,27
SKP 300	300 mm <sup>2</sup>	M 20	14	34,50 ₺	48	43,4	20	21	24	30,12	120	100	5,87
SKP 400	400 mm <sup>2</sup>	M 20	10	41,65 ₺	48	50	23	21	27,2	34,85	122	117,6	6,9

### SIKMALI EK MUFLARI COMPRESSIVE CONNECTORS

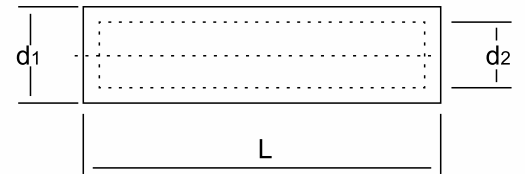

KOD CODE	KESİT CROSS SECTION	KUTU / ADET UNIT / BOX	FİYAT PRICE	L (mm)	d1 (mm)	d2 (mm)	d1-d2/2 (mm)
SEM 06	6 mm <sup>2</sup>	1500	0,85 ₺	30,2	5,8	4,1	0,85
SEM 10	10 mm <sup>2</sup>	1000	1,05 ₺	40,1	6,78	5,1	0,84
SEM 16	16 mm <sup>2</sup>	400	1,25 ₺	42	8,25	6,7	0,775
SEM 25	25 mm <sup>2</sup>	250	2,10 ₺	50	9,9	7,22	1,34
SEM 35	35 mm <sup>2</sup>	200	2,65 ₺	52	11,37	9,1	1,135
SEM 50	50 mm <sup>2</sup>	150	3,75 ₺	58	12,9	10	1,45
SEM 70	70 mm <sup>2</sup>	100	4,85 ₺	61,5	14,3	11,5	1,4
SEM 95	95 mm <sup>2</sup>	75	6,00 ₺	68	16,7	13,3	1,7
SEM 120	120 mm <sup>2</sup>	50	8,25 ₺	70	19,4	15,5	1,95
SEM 150	150 mm <sup>2</sup>	35	12,15 ₺	80	21,8	18	1,9
SEM 185	185 mm <sup>2</sup>	25	14,55 ₺	84	22,9	18,6	2,15
SEM 240	240 mm <sup>2</sup>	18	22,75 ₺	92	26,8	21,6	2,6
SEM 300	300 mm <sup>2</sup>	14	30,25 ₺	101	30,3	24,4	2,95
SEM 400	400 mm <sup>2</sup>	10	36,00 ₺	120	34	27	3,5
SEM 630	630 mm <sup>2</sup>	5	73,85 ₺	140	43,8	34,8	4,5

## SIKMALI ALÜMİNYUM İLETKENLER

COMPRESSIVE ALUMINIUM CONNECTORS

### SIKMALI KABLO PABUÇLARI COMPRESSIVE CABLE LUGS

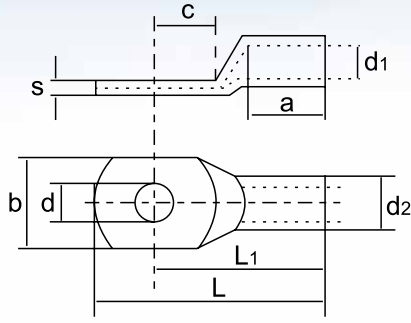

KOD CODE	KESİT CROSS SECTION	BAĞLANTI SCREW DIAMETER	KUTU / ADET UNIT / BOX	FİYAT PRICE	a (mm)	b (mm)	c (mm)	d (mm)	d1 (mm)	d2 (mm)	L (mm)	L1 (mm)	s (mm)
ASKP 16	16 mm <sup>2</sup>	M6	400	1,35 ₺	20	13	7,5	6,5	6	10	56	48,5	4
ASKP 25	25 mm <sup>2</sup>	M6	250	1,70 ₺	20	15	9	8,5	7	12	62	53	4,5
ASKP 35	35 mm <sup>2</sup>	M6	200	2,40 ₺	20	19	10	10,5	8,2	14	75	63	5
ASKP 50	50 mm <sup>2</sup>	M8	150	3,10 ₺	28	22	11,5	10,5	10	16	80	69,5	5,5
ASKP 70	70 mm <sup>2</sup>	M8	100	3,85 ₺	28	24	12,5	10,5	12	18	95	81,5	6
ASKP 95	95 mm <sup>2</sup>	M10	75	6,40 ₺	35	28	13,5	13	13,5	22	102	88,5	8,5
ASKP 120	120 mm <sup>2</sup>	M10	50	8,25 ₺	35	32	16	13	16	23	112	96	6,5
ASKP 150	150 mm <sup>2</sup>	M12	35	9,35 ₺	35	34	17,5	13	17	26	114	96,5	8
ASKP 185	185 mm <sup>2</sup>	M12	25	11,35 ₺	40	37	19	15	18,5	28	125	106	8
ASKP 240	240 mm <sup>2</sup>	M12	18	15,60 ₺	40	42	20	17	22	32	141,5	121,5	10,5
ASKP 300	300 mm <sup>2</sup>	M16	8	19,80 ₺	76	46,5	31,5	17	23,5	34	142,5	118	10,6
ASKP 400	400 mm <sup>2</sup>	M20	5	31,50 ₺	115	50,6	33,5	21	25	36	190	160	9,8
ASKP 500	500 mm <sup>2</sup>	M20	5	40,50 ₺	115	-	-	21	-	-	190	160	-

### SIKMALI EK MUFLARI COMPRESSIVE CONNECTORS

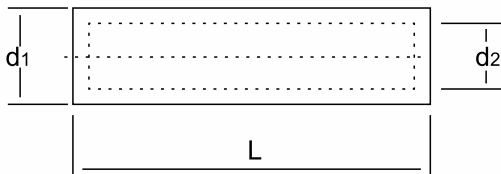

KOD CODE	KESİT CROSS SECTION	KUTU / ADET UNIT / BOX	FİYAT PRICE	L (mm)	d1 (mm)	d2 (mm)	d1-d2/2 (mm)
ASEM 16	16 mm <sup>2</sup>	400	1,15 ₺	60	10	5,6	2,2
ASEM 25	25 mm <sup>2</sup>	250	1,50 ₺	70	11,5	7	2,25
ASEM 35	35 mm <sup>2</sup>	200	2,15 ₺	76	14	8,2	2,9
ASEM 50	50 mm <sup>2</sup>	150	2,95 ₺	83	16	10	3
ASEM 70	70 mm <sup>2</sup>	100	3,80 ₺	97	18	11,5	3,25
ASEM 95	95 mm <sup>2</sup>	75	4,50 ₺	109	21	13,5	3,75
ASEM 120	120 mm <sup>2</sup>	50	5,50 ₺	109	22	15	3,5
ASEM 150	150 mm <sup>2</sup>	35	8,00 ₺	118,5	25	16,5	4,25
ASEM 185	185 mm <sup>2</sup>	25	10,80 ₺	125,5	28	18,5	4,75
ASEM 240	240 mm <sup>2</sup>	18	15,10 ₺	141,5	32	21,2	5,4
ASEM 300	300 mm <sup>2</sup>	12	19,10 ₺	143	34	24,5	4,75
ASEM 400	400 mm <sup>2</sup>	10	25,65 ₺	150	36	25	5,5
ASEM 500	500 mm <sup>2</sup>	5	42,60 ₺	162	40	27,5	6,25

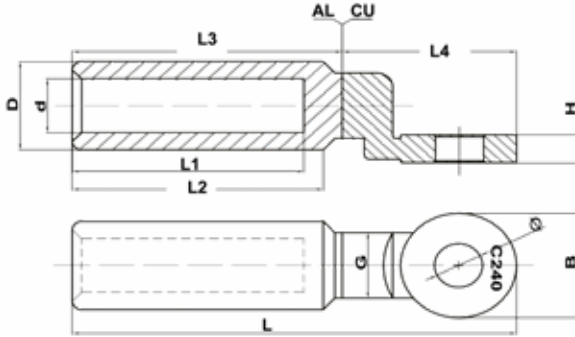

KOD CODE	KESİT CROSS SECTION	BAĞLANTI SCREW DIAMETER	FİYAT PRICE	D (mm)	d (mm)	L±2 (mm)	L1±1 (mm)	L2±1.5 (mm)	L3 (mm)	L4 (mm)	B (mm)	H (mm)
BTSKP 16	16 mm <sup>2</sup>	M 8	2,86 \$	16	5,5	82	38	48	52	30	20	4
BTSKP 25	25 mm <sup>2</sup>	M 8	2,86 \$	16	6,5	82	38	48	52	30	20	4
BTSKP 35	35 mm <sup>2</sup>	M 8	2,86 \$	16	8,2	82	38	48	52	30	20	4
BTSKP 50	50 mm <sup>2</sup>	M 10	3,25 \$	20	9,7	88	43	48	52	36	24	5
BTSKP 70	70 mm <sup>2</sup>	M 10	3,25 \$	20	11	88	43	48	52	36	24	5
BTSKP 95	95 mm <sup>2</sup>	M 10	3,25 \$	20	12,5	88	43	48	52	36	24	5
BTSKP 120	120 mm <sup>2</sup>	M 12	5,19 \$	25	13,7	110	60	64	68	44	30	6
BTSKP 150	150 mm <sup>2</sup>	M 12	5,19 \$	25	15,5	110	60	64	68	44	30	6
BTSKP 185	185 mm <sup>2</sup>	M 12	8,62 \$	32	17,5	120	60	64	70	50	35	8
BTSKP 240	240 mm <sup>2</sup>	M 12	8,62 \$	32	19,5	120	60	64	70	50	35	8
BTSKP 300	300 mm <sup>2</sup>	M 12	16,15 \$	40	23	160	93	101	108	52	36	8
BTSKP 400	400 mm <sup>2</sup>	M 12	16,15 \$	40	26,2	160	93	101	108	52	36	8

## BİMETAL SIKMALI EK MUF

### BI METAL COMPRESSIVE CONNECTORS

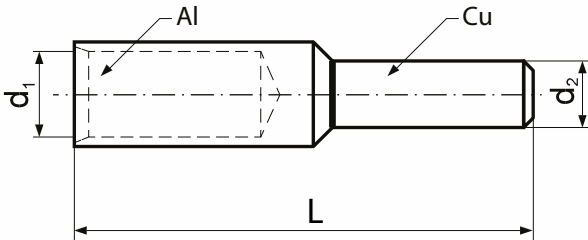

KOD CODE	KESİT CROSS SECTION	FİYAT PRICE	d1 (mm)	d2 (mm)	L (mm)
BTSEM 35-16	35-16 mm <sup>2</sup>	1,58 \$	8,5	7,0	85,0
BTSEM 50-25	50-25 mm <sup>2</sup>	2,00 \$	9,8	8,5	90,0
BTSEM 70-35	70-35 mm <sup>2</sup>	2,68 \$	11,5	9,8	100,0
BTSEM 95-50	95-50 mm <sup>2</sup>	4,05 \$	13,5	11,5	110,0
BTSEM 120-70	120-70 mm <sup>2</sup>	4,48 \$	15,0	13,5	110,0
BTSEM 150-95	150-95 mm <sup>2</sup>	5,37 \$	16,5	15,0	115,0
BTSEM 185-120	185-120 mm <sup>2</sup>	7,10 \$	18,5	16,5	125,0
BTSEM 240-150	240-150 mm <sup>2</sup>	10,55 \$	21,0	18,5	130,0



### MEKANİK SIKMALI EK MUF BOLTED CONNECTOR

KOD CODE	FİYAT PRICE	KABLO KESİTİ CROSS SECTION (mm <sup>2</sup> )	DIŞ ÇAP OUTER D. (mm)	VİDA SAYISI BOLT NUMBER	KUTU/ADET UNIT/BOX
MSEM 25-95/2	22,00 \$	25-95	24	2	40
MSEM 35-150/4	24,00 \$	35-150	28	4	20
MSEM 70-240/4	30,00 \$	70-240	33	4	15
MSEM 120-300/4	38,00 \$	120-300	38	4	10
MSEM 185-400/6	42,00 \$	185-400	42	6	9
MSEM 500-630/6	84,00 \$	500-630	52	6	4



### MEKANİK SIKMALI KABLO PABUCU BOLTED LUG

KOD CODE	FİYAT PRICE	KABLO KESİTİ CROSS SECTION (mm <sup>2</sup> )	DIŞ ÇAP OUTER D. (mm)	VİDA SAYISI BOLT NUMBER	KUTU/ADET UNIT/BOX
MSKP 25-95-12/2	16,00 \$	25-95	24	2	40
MSKP 35-150-12/2	18,00 \$	35-150	28	2	20
MSKP 70-240-12/2	25,00 \$	70-240	33	2	12
MSKP 120-300-16/2	36,00 \$	120-300	38	2	9
MSKP 185-400-16/3	39,00 \$	185-400	42	3	7



### BİMETAL MEKANİK SIKMALI KABLO PABUCU BI METAL BOLTED LUG

KOD CODE	FİYAT PRICE	KABLO KESİTİ CROSS SECTION (mm <sup>2</sup> )	DIŞ ÇAP OUTER D. (mm)	VİDA SAYISI BOLT NUMBER	KUTU/ADET UNIT/BOX
BMSKP 35-150-12/2	24,00 \$	35-150	28	2	80
BMSKP 70-240-12/2	30,00 \$	70-240	33	2	48
BMSKP 120-300-12/2	40,00 \$	120-300	38	2	36
BMSKP 185-400-16/2	70,00 \$	185-400	42	2	28

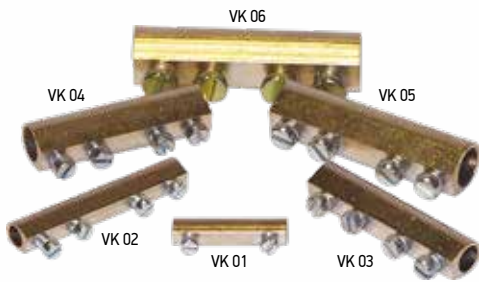

### VİDALI KLEMENSLER SCREWED CONNECTORS

KOD CODE	KABLO KESİTİ CROSS SECTION (mm <sup>2</sup> )	UZUNLUK LENGTH (mm)	ÇAP DIAMETER (mm)	FİYAT PRICE
VK 01	1,5 - 6	28	4,5	1,40 ₺
VK 02	10 - 16	50	5,5	1,60 ₺
VK 03	25	50	7	2,30 ₺
VK 04	35	56	8,5	2,95 ₺
VK 05	50	55	10	3,65 ₺
VK 06	70	60	12	4,25 ₺

### C - H KLEMENSLER C - H TYPE CONNECTORS

KOD CODE	KABLO KESİTİ CROSS SECTION (mm <sup>2</sup> )	UZUNLUK LENGTH (mm)	ÇAP DIAMETER (mm)	FİYAT PRICE
CK 01	6 - 10 - 16	18	12	6,80 ₺
CK 02	25 - 35	27	20	9,90 ₺
CK 03	50 - 70 - 95	32	25	12,60 ₺
HK 01	50 - 95	30	22	14,55 ₺

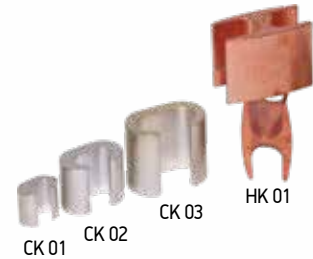



**t<sup>⚡</sup>e TAMER<sup>®</sup>**  
**ELEKTRİK**

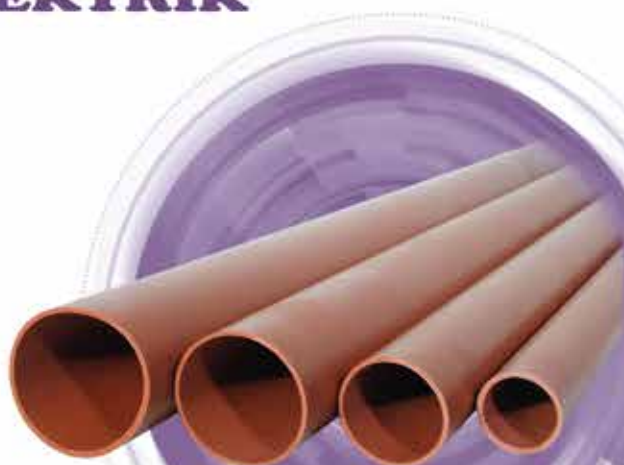

### REÇİNELİ YALITIM BORULARI WITH RESIN INSULATION TUBES

KOD CODE	(a) DARALMA ÖNCESİ BEFORE EXPANDED (mm) $\Phi$	(b) DARALMA SONRASI AFTER EXPANDED (mm) $\Phi$	(L) UZUNLUK LENGTH (m)	FİYAT PRICE (m/₺)
TIB 9/3	9	3	1,2	6,60 ₺
TIB 12/4	12	4	1,2	15,95 ₺
TIB 16/5	16	5	1,2	19,50 ₺
TIB 22/6	22	6	1,2	20,00 ₺
TIB 25/8	25	8	1,2	23,45 ₺
TIB 33/10	33	10	1,15	24,30 ₺
TIB 40/12	40	12	1,15	25,60 ₺
TIB 45/15	45	15	1,15	32,90 ₺
TIB 54/18	54	18	1,15	33,40 ₺
TIB 65/22	65	22	1,15	33,40 ₺
TIB 75/22	75	22	1,15	38,85 ₺
TIB 80/30	80	30	1,15	48,95 ₺
TIB 90/30	90	30	1,15	49,90 ₺
TIB 105/33	105	33	1,15	56,70 ₺
TIB 125/40	125	40	1,50	66,20 ₺
TIB 140/40	140	40	1,50	76,45 ₺
TIB 150/50	150	50	1,50	149,50 ₺
TIB 170/58	170	58	1,50	163,60 ₺

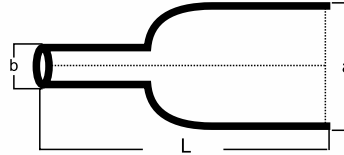
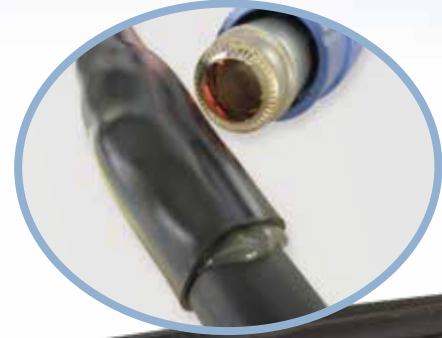

### BARA İZOLASYON BORULARI BUSBAR INSULATION TUBES



KOD CODE	(a) DARALMA ÖNCESİ BEFORE EXPANDED (mm) $\Phi$	(b) DARALMA SONRASI AFTER EXPANDED (mm) $\Phi$	(L) UZUNLUK LENGTH (m)	FİYAT PRICE (m/₺)
TAIB 21/7	21	7	1,15 veya (25m/rulo)	59,15 ₺
TAIB 33/10	33	10	1,15 veya (25m/rulo)	68,10 ₺
TAIB 38/12	38	12	1,15 veya (25m/rulo)	71,85 ₺
TAIB 45/17	45	17	1,15 veya (25m/rulo)	84,00 ₺
TAIB 54/18	54	18	1,15 veya (25m/rulo)	87,15 ₺
TAIB 60/22	60	22	1,15 veya (25m/rulo)	87,15 ₺
TAIB 65/22	65	22	1,15 veya (25m/rulo)	87,15 ₺
TAIB 75/22	75	22	1,15 veya (25m/rulo)	87,15 ₺
TAIB 90/30	90	30	1,15 veya (25m/rulo)	104,00 ₺
TAIB 110/40	110	40	1,15 veya (25m/rulo)	120,00 ₺
TAIB 125/40	125	40	1,15 veya (25m/rulo)	120,00 ₺
TAIB 140/40	140	40	1,15	120,00 ₺
TAIB 160/50	160	50	1,15	191,00 ₺



KOD CODE	(a) DARALMA ÖNCESİ BEFORE EXPANDED (mm) $\Phi$	(b) DARALMA SONRASI AFTER EXPANDED (mm) $\Phi$	(L) UZUNLUK LENGTH (m)	FİYAT PRICE (m/€)
TFB 30/12	30	12	1	30,00 €
TFB 38/12	38	12	1	30,00 €
TFB 50/18	50	18	1	33,00 €
TFB 65/22	65	22	1	37,00 €
TFB 85/30	85	30	1	40,50 €
TFB 100/35	100	35	1	45,00 €

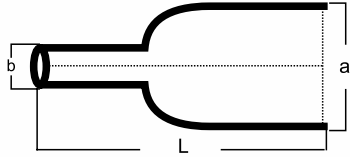

## UÇ KORUYUCULARI END CAPS



KOD CODE	(a) DARALMA ÖNCESİ BEFORE EXPANDED (mm) $\Phi$	(b) DARALMA SONRASI AFTER EXPANDED (mm) $\Phi$	(L) UZUNLUK LENGTH (mm)	FİYAT PRICE
UK 11/5	11	$\leq 5,5$	22	6,25 ₺
UK 16/7	16	$\leq 7,5$	75	7,85 ₺
UK 25/10	25	$\leq 10,5$	80	8,65 ₺
UK 32/16	32	$\leq 16,5$	90	9,85 ₺
UK 50/26	50	$\leq 26$	115	12,00 ₺
UK 70/37	70	$\leq 37$	120	15,50 ₺
UK 100/46	100	$\leq 46$	140	18,25 ₺
UK 120/57	120	$\leq 57$	155	21,50 ₺



# ISI BÜZÜŞMELİ MAKARONLAR

HEAT SHRINKABLE THIN WALL TUBES

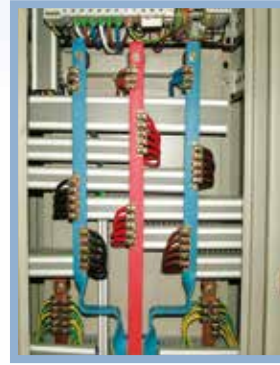

KOD CODE	DARALMA ÖNCESİ BEFORE EXPANDED (mm <sup>2</sup> )	DARALMA SONRASI AFTER EXPANDED (mm <sup>2</sup> )	BARAYA UYGUNLUĞU Busbar Eligibility	KABLO PABUCUNA UYGUNLUK Cable Lug Eligibility	SİYAH BLACK m / \$	RENKLİ COLOR m / \$	SARI - YEŞİL YELLOW - GREEN m / \$	PAKET RULO PACKING (m)
MAK 1.5	1.5	0.75			0,0700 \$	0,0886 \$	0,3595 \$	200
MAK 2.5	2.5	1.25			0,1058 \$	0,1300 \$	0,3234 \$	200
MAK 3.5	3.5	1.75			0,1234 \$	0,1535 \$	0,2268 \$	200
MAK 4.5	4.5	2.25			0,1587 \$	0,1955 \$	0,2640 \$	100
MAK 5.0	5.0	2.5			0,1765 \$	0,2168 \$	0,2820 \$	100
MAK 6.0	6.0	3.0			0,2029 \$	0,2515 \$	0,3335 \$	100
MAK 7.0	7.0	3.5			0,2118 \$	0,2732 \$	0,3450 \$	100
MAK 8.0	8.0	4.0			0,2383 \$	0,2898 \$	0,3965 \$	100
MAK 10	10	5		6-10	0,2919 \$	0,3583 \$	0,4950 \$	100
MAK 12	12	6		6-10	0,3355 \$	0,4132 \$	0,6085 \$	100
MAK 13	13	6.5	12x2-15x2-15x3	16-25	0,3465 \$	0,4224 \$	0,7015 \$	100
MAK 16	16	8	20x2-20x3	16-25-35-50	0,5675 \$	0,6839 \$	0,9790 \$	100
MAK 18	18	9	20x5	35-50	0,7449 \$	0,9017 \$	1,0900 \$	100
MAK 20	20	10	20x5-25x3-25x5	70	0,9326 \$	1,1215 \$	1,8605 \$	100
MAK 22	22	11	25x5-30x3-30x5	70-95	1,1383 \$	1,3773 \$	1,6085 \$	100
MAK 25	25	12.5	25x5-30x3-30x5	70-95	1,2230 \$	1,4776 \$	1,8335 \$	50
MAK 28	28	14	40x3	70-95	1,6469 \$	1,9950 \$	2,1000 \$	50
MAK 30	30	15	40x3-40x5	120	1,6768 \$	2,0304 \$	2,4610 \$	50
MAK 32	32	16	30x10-40x5	120-150	2,4289 \$	2,7917 \$	2,9420 \$	50
MAK 35	35	17.5	30x10-40x5-40x10	150	2,4360 \$	2,9400 \$	3,0250 \$	50
MAK 38	38	19	40x5-40x10	185-240	2,5515 \$	3,0402 \$	3,4650 \$	50
MAK 40	40	20	50x5	185-240-300	2,7360 \$	3,3095 \$	3,4650 \$	50
MAK 45	45	22.5	50x5-50x10	240-300-400	2,9715 \$	3,5935 \$	4,3610 \$	25
MAK 50	50	25	60x5-60x10	400	3,1783 \$	4,0125 \$	4,7460 \$	25
MAK 60	60	30	80x5-80x10		4,4134 \$	4,9945 \$	6,6220 \$	25
MAK 70	70	35	100x5-100x10		5,5605 \$	6,7520 \$	8,9370 \$	25
MAK 80	80	40	100x5-100x10		6,1820 \$	7,6595 \$	10,9000 \$	25
MAK 90	90	45	100x10		7,2060 \$	8,7555 \$	13,8255 \$	25
MAK 100	100	50	120x10		9,9750 \$	10,6500 \$	16,7000 \$	25
MAK 120	120	60	120x10-160x10		12,7000 \$	14,4650 \$	21,0500 \$	25
MAK 150	150	75	160x10		16,0850 \$	18,6585 \$	29,1000 \$	25

**ÖZEL BANTLAR**  
**SPECIAL TAPES**



KOD CODE	CİNSİ TYPE	KALINLIK THICKNES (mm)	EN WIDTH (mm)	UZUNLUK LENGTH (m)	KUTU / ADET UNIT / BOX	FİYAT PRICE
PB 131910	Plastik Bant (0,6kV)	0,13	19	10	500	0,45 \$
PB 131925	Plastik Bant (0,6kV)	0,13	19	25	60	1,20 \$
PB 135025	Plastik Bant (0,6kV)	0,13	50	25	80	2,85 \$
TE 1401	Eriyen Bant (10kV)	0,76	19	8	60	2,85 \$
TE 1402	Eriyen Bant (10kV)	0,76	50	8	24	7,30 \$
TE 1403	Eriyen Bant (36kV)	0,76	19	9	60	7,50 \$
YİB 01	Yarı İletken Bant	0,75	19	5	96	9,70 \$

KOD CODE	CİNSİ TYPE	FİYAT PRICE
HYK 63	63 mm Huni Yan Kapak	2,00 ₺
HYK 75	75 mm Huni Yan Kapak	4,00 ₺
HYK 90	90 mm Huni Yan Kapak	8,00 ₺
HYK 100	100 mm Huni Yan Kapak	10,00 ₺
HYK 125	125 mm Huni Yan Kapak	12,00 ₺
KBH 01	Kablo Başlığı Hunisi	4,00 ₺
KBH 02	Kablo Başlığı Hunisi	5,00 ₺
KBH 03	Kablo Başlığı Hunisi	6,00 ₺
EMH 4205	4 x 2,5 Ek Muf Hunisi (Takım)	6,00 ₺
EMH 63	4 x 10 - 4 x 16 Ek Muf Hunisi Tk.	12,00 ₺
EMH 64	3 x 25 + 16 - 3 x 50 + 25 Ek Muf Hunisi Tk.	12,00 ₺
EMH 70 - 95	70 - 95 mm Ek Muf Hunisi (Takım)	15,50 ₺
EMH 120-150	120 - 150 mm Ek Muf Hunisi (Takım)	24,00 ₺
EMH 185-240	185 - 240 mm Ek Muf Hunisi (Takım)	32,00 ₺

**PLASTİK HUNİ KALIPLARI**  
**PLASTIC FUNNEL MOULDS**

**EK MUF KALIPLARI**  
**JOINT MOULDS**

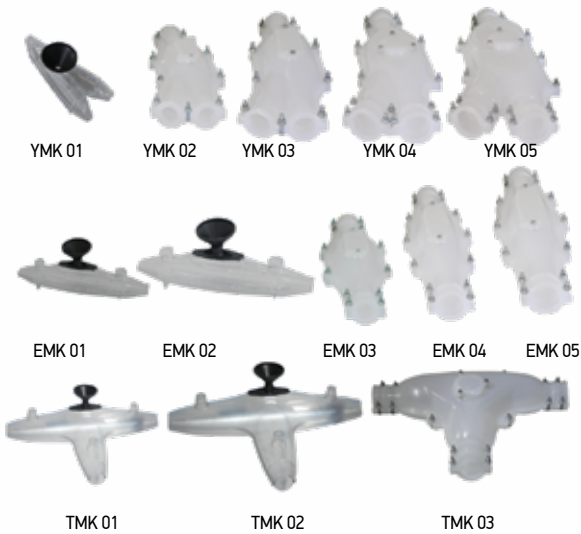
KOD CODE	CİNSİ TYPE	Uygun Kablo Kesiti	FİYAT PRICE
YMK 01	Y Branşman Ek Mufu Kalıbı No: 1	1,5-10	15,25 ₺
YMK 02	Y Branşman Ek Mufu Kalıbı No: 2	10-25	115,00 ₺
YMK 03	Y Branşman Ek Mufu Kalıbı No: 3	35-70	141,00 ₺
YMK 04	Y Branşman Ek Mufu Kalıbı No: 4	95-120	175,00 ₺
YMK 05	Y Branşman Ek Mufu Kalıbı No: 5	150-240	222,50 ₺
EMK 01	Şeffaf Düz Ek Muf Kalıbı No: 1	10-25	18,00 ₺
EMK 02	Şeffaf Düz Ek Muf Kalıbı No: 2	35-95	24,00 ₺
EMK 03	Şeffaf Düz Ek Muf Kalıbı No: 3	10-25	88,45 ₺
EMK 04	Şeffaf Düz Ek Muf Kalıbı No: 4	35-70	122,00 ₺
EMK 05	Şeffaf Düz Ek Muf Kalıbı No: 5	95-240	163,00 ₺
TMK 01	T Branşman Ek Muf Kalıbı No: 1	10-25	38,50 ₺
TMK 02	T Branşman Ek Muf Kalıbı No: 2	35-95	55,00 ₺
TMK 03	T Branşman Ek Muf Kalıbı No: 3	120-240	168,00 ₺

**BUAT KAPAĞI**  
**JUNCTION COVER**

KOD CODE	GÖVDE ÇAPİ MAIN DIAMETER (cm)	TIRNAK UZUNLUĞU LOCK OF LENGTH (cm)	KUTU / ADET UNIT / BOX	FİYAT PRICE
BK 01	9,1	8,3	250	0,80 ₺



## 36 kV EKSPANLI KABLO BAŞLIKLARI PLUG IN CABLE TERMINATION



KOD CODE	CİNSİ TYPE	KABLO KESİTİ CROSS SECTION (mm <sup>2</sup> )	KABLO YALITKAN ÇAPI INSULATION DIAMETER OF CABLE (mm <sup>2</sup> )	FİYAT PRICE
TLS36 35-70	L TİPİ	35-70	26-29	☎
TLS36 95-150		95-150	30-34	
TLS36 185-240		185-240	35-40	
TLS36 400-500		400-500	41-46	
TTS36 35-70	T TİPİ	35-70	26-29	☎
TTS36 95-150		95-150	30-34	
TTS36 185-240		185-240	35-40	
TTS36 400-500		400-500	41-46	

## AG & OG YALITIM HALISI LV & MV INSULATION SHEET

KOD CODE	YALITIM DEĞERİ INSULATION RATE	FİYAT PRICE
TH06	1kV'a Kadar	☎
TH36	36kV'a Kadar	☎



## OG YALITIM SEHPASI MV INSULATION STAND

KOD CODE	YALITIM DEĞERİ INSULATION RATE	FİYAT PRICE
TS36	36kV'a Kadar	☎

## OG YALITIM ELDİVENİ MV INSULATION GLOVE

KOD CODE	YALITIM DEĞERİ INSULATION RATE	FİYAT PRICE
TE36	36kV'a Kadar	☎



## DİKKAT ÖLÜM TEHLİKESİ UYARI LEVHASI WARNING SIGN

KOD CODE	CİNSİ TYPE	FİYAT PRICE
TLE36	Sarı Paslanmaz Metal Levha	☎

## HAVAI HAT KİLİTLEME EL ALETİ OVERHEAD-LINE HAND TOOL

KOD CODE	CİNSİ TYPE	FİYAT PRICE
THK 2R	2 açılı, paslanmaz, kilitleme	200,00 ₺



## MEKANİK BAĞLAYICI SIKMA EL ALETİ BOLTED HAND TOOL

KOD CODE	CİNSİ TYPE	FİYAT PRICE
TTA 10630	Mekanik Lokma Takımı (Taşıma Kılıflı)	☎

## ŞEFAF PLASTİK KABLO BAĞLARI



Kod	Boyut (mm)		Renk	Adet/Paket	Adet Fiyat ₺	Paket/Kutu	Koli Ölçüsü (cm)	Koli Net Ağırlık (kg)	Min Gerilme Direnci (KGS)
	En (W)	Uzunluk (L)							
TFX 25100	2,5	100	Şeffaf	100	0,021 ₺	500	54*33*30	12,5	8
TFX 25150	2,5	150	Şeffaf	100	0,034 ₺	300	54*33*30	11	8
TFX 25200	2,5	200	Şeffaf	100	0,048 ₺	300	54*33*32	15	8
TFX 36150	3,6	150	Şeffaf	100	0,057 ₺	250	54*33*32	15,5	18
TFX 36200	3,6	200	Şeffaf	100	0,073 ₺	200	54*33*32	17,0	18
TFX 36250	3,6	250	Şeffaf	100	0,097 ₺	150	54*33*32	15,0	18
TFX 36300	3,6	300	Şeffaf	100	0,115 ₺	150	54*33*32	19,5	18
TFX 36380	3,6	380	Şeffaf	100	0,145 ₺	120	54*33*32	19,5	18
TFX 48200	4,8	200	Şeffaf	100	0,100 ₺	150	54*33*32	20,0	22
TFX 48250	4,8	250	Şeffaf	100	0,135 ₺	130	54*33*32	20,0	22
TFX 48300	4,8	300	Şeffaf	100	0,154 ₺	100	54*33*32	19	22
TFX 48380	4,8	380	Şeffaf	100	0,195 ₺	80	54*33*30	19,5	22
TFX 48450	4,8	450	Şeffaf	100	0,250 ₺	70	54*33*30	21	22
TFX 48500	4,8	500	Şeffaf	100	0,346 ₺	60	54*33*32	20	22
TFX 76300	7,6	300	Şeffaf	100	0,288 ₺	50	54*33*32	20,0	55
TFX 76380	7,6	380	Şeffaf	100	0,354 ₺	50	54*33*32	20,5	55
TFX 76450	7,6	450	Şeffaf	100	0,440 ₺	35	54*33*32	19,0	55
TFX 76550	7,6	550	Şeffaf	100	0,594 ₺	30	62*36*23	20,5	55
TFX 90700	9,0	700	Şeffaf	100	0,990 ₺	10	80*25*21	12,0	80
TFX 90800	9,0	800	Şeffaf	100	1,072 ₺	10	115*25*21	13,0	80

## ETİKET KABLO BAĞLARI



Kod	Boyut (mm)		Renk	Adet/Paket	Adet Fiyat ₺	Paket/Kutu	Koli Ölçüsü (cm)	Koli Net Ağırlık (kg)	Min Gerilme Direnci (KGS)
	En (W)	Uzunluk (L)							
TFXE 25100	2,5	100	Şeffaf	100	0,075 ₺	200	54*33*30	12	8
TFXE 36205	3,6	205	Şeffaf	100	0,134 ₺	100	54*33*30	13	8

## SIYAH PLASTİK KABLO BAĞLARI



Kod	Boyut (mm)		Renk	Adet/Paket	Adet Fiyat ₺	Paket/Kutu	Koli Ölçüsü (cm)	Koli Net Ağırlık (kg)	Min Gerilme Direnci (KGS)
	En (W)	Uzunluk (L)							
TFXS 36250	3,6	250	Siyah	100	0,097 ₺	150	54*33*32	15,0	18
TFXS 36300	3,6	300	Siyah	100	0,115 ₺	150	54*33*32	19,5	18
TFXS-U 36300	3,6	300	Siyah	100	0,175 ₺	150	54*33*32	19,5	18
TFXS 36380	3,6	380	Siyah	100	0,145 ₺	120	54*33*32	19,5	18
TFXS-U 36380	3,6	380	Siyah	100	0,198 ₺	120	54*33*32	19,5	18
TFXS 48300	4,8	300	Siyah	100	0,154 ₺	100	54*33*32	19	22
TFXS 48380	4,8	380	Siyah	100	0,195 ₺	80	54*33*30	19,5	22
TFXS-U 48380	4,8	380	Siyah	100	0,338 ₺	80	54*33*30	19,5	22
TFXS 48450	4,8	450	Siyah	100	0,250 ₺	70	54*33*30	21	22
TFXS-U 48450	4,8	450	Siyah	100	0,377 ₺	70	54*33*30	21	22
TFXS 76300	7,6	300	Siyah	100	0,288 ₺	50	54*33*32	20,0	55
TFXS 76380	7,6	380	Siyah	100	0,354 ₺	50	54*33*32	20,5	55
TFXS 76550	7,6	550	Siyah	100	0,594 ₺	30	62*36*23	20,5	55



## PASLANMAZ ÇELİK KABLO BAĞLARI

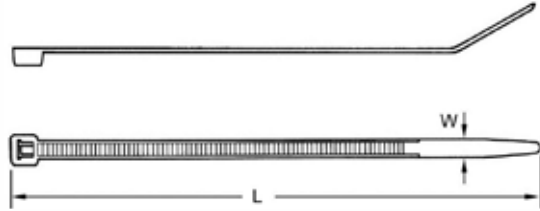

Kod	Boyut (mm)		Renk	Adet/Paket	Adet Fiyat ₺	Paket/Kutu	Koli Ölçüsü (cm)	Koli Net Ağırlık (kg)
	En (W)	Uzunluk (L)						
TFXC 46250	4,6	250	Paslanmaz Çelik	100	0,905 ₺	50	42*20*15	14
TFXC 46300	4,6	300	Paslanmaz Çelik	100	0,935 ₺	50	42*20*20	19
TFXC 46400	4,6	400	Paslanmaz Çelik	100	1,020 ₺	50	42*20*20	21
TFXC 46550	4,6	550	Paslanmaz Çelik	100	1,200 ₺	30	60*20*20	18
TFXC 46850	4,6	850	Paslanmaz Çelik	100	2,075 ₺	20	90*20*20	18

## YAPIŞKAN KROŞELER

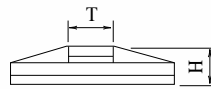
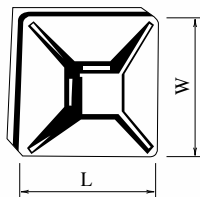

Kod	Boyut (mm)	Renk	Adet/Paket	Adet Fiyat ₺	Paket/Kutu	H (mm)	T (mm)	Vida Delip Çapı (mm)	Koli Ölçüsü (cm)	Koli Net Ağırlık (kg)
	L x W									
TFXK 2020	20x20	Beyaz	100	0,136 ₺	200	6,1	5	2,9	54*33*30	14
TFXK 3030	30x30	Beyaz	100	0,195 ₺	50	8,7	6,4	4,5	54*33*30	14





# *Elektriksel Yalıtımda Yerli Çözümler*



**TAMER**

*tamflex*

**ProSil**

**TAMER ELEKTRİK**  
**İMALAT SANAYİ TİCARET LİMİTED ŞİRKETİ**

**MERKEZ / HEAD OFFICE**

Sanayi Caddesi No: 26/B Ulus - ANKARA / TÜRKİYE

Tel : +90 312 **324 12 71 - 311 94 71 - 310 18 05**

Fax : +90 312 **324 45 74**

**ŞUBE / BRANCH**

Anafartalar Mah. Kuruçesme Sk. No: 3/A-B Ulus - ANKARA / TÜRKİYE

Tel : +90 312 **324 12 71 - 311 94 71 - 310 18 05**

Fax : +90 312 **324 45 74**

**ŞUBE / BRANCH**

Elektrokent İş Merkezi 1467. Cad. No: 2/29

İvedik O.S.B. / Ostim / ANKARA / TÜRKİYE

Tel : +90 312 **395 17 20 - 21 - 24**

Fax : +90 312 **395 17 23**

**FABRİKA / FACTORY**

İstanbul Yolu 26. Km. Saray Mah. Saray Cad. No: 4

Kazan - ANKARA / TÜRKİYE

Tel : +90 312 **815 44 74 - 815 45 52**

Fax : +90 312 **815 45 53**

[www.tamerelektrik.com.tr](http://www.tamerelektrik.com.tr)

[tamer@tamerelektrik.com.tr](mailto:tamer@tamerelektrik.com.tr) - [info@tamerelektrik.com.tr](mailto:info@tamerelektrik.com.tr)



ISO-EN  
9001

ISO-EN  
14001

OHSAS  
18001

RoHS

CE

