

FİYAT LİSTESİ
PRICE LIST



Ritā

YENİLİĞİ HİSSET
IŞIĞA YÖN VER

NATURAL

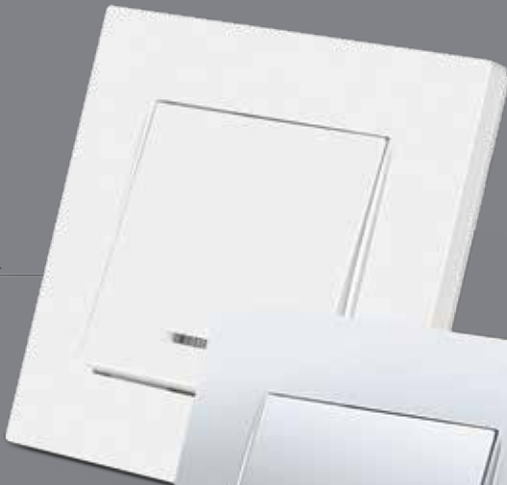

AHŞAP



METALİK



PASTEL



TEKNOLOJİ VE TASARIMIN YENİ MEKANİZMASI

Yeni

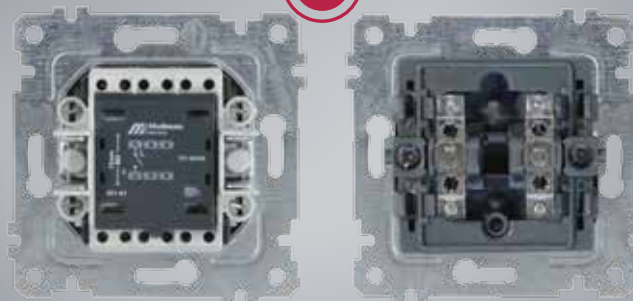

içindekiler

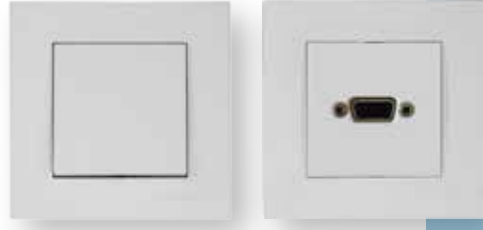

Ritâ	4
Elitra Plus	10
Candelâ	15
Dariâ	25
BRON	28
Nemliyer	30
Grup Prizler	32

tesisat grubu

Canalex serisi kapalı tip kablo kanalları	36
Eko serisi kapalı tip kablo kanalları	36
Yapışkan bantlı kapalı tip kablo kanalları	36
Kanal için UPS ve enerji prizleri 45x45	37
Döşeme altı priz sistemleri	37
Meks serisi kapalı tip kablo kanalları	37
Meks serisi klima kanalı ve aksesuarları	37
Tavan köşe kanalı	37
Süpürgelik kablo kanalları	37
Fuğalı süpürgelik	37
Tezgah süpürgeliği	37
Balık sırtı zemin kanalları	37
Kanal aksesuarları	38
Meks plus serisi için priz setleri	39
Sidem serisi renkli kablo kanalları	39
Sidem serisi süpürgelikler ve aksesuarları	40
Kablolu Spiraller	45
Spiraller	47
Polyamid Spiral rekor ve dirsekler	47
H. free Spiraller	48
Kablo toplama ve pano spiralleri	48
Eko serisi çelik ve izole kaplı spiraller	49
Meks serisi çelik ve izole kaplı spiraller	49
Rakorlar	50
Borular	51
HDPE koruge borular	51
Plastik dirsek ve muflar	52
PVC boy borular ve muflar	52
PVC boy boru kroşeleri	53
Buatlar ve kapakları	53
Sustalar	54
Kofra-kesicili kofra ve buşonlar	55
Basınç şalterleri ve seviye flatörleri	55
Şalterler	55
Comfort W otomat kutuları	58
Comfort zayıf akım kutuları	58
Meksbox W otomat Kutuları	59
Duylar	60
Telefon kutuları ve aksesuarları	60
Kontrol kalemi, pense ve takım çantaları	61
Dübeller, vidalar ve kroşeler	63
Wago klemens ve ölçü aletleri	64
Klemensler	65
Merdiven otomatiği ve röleler	66
Ziller ve trafolar	66
Duman ve gaz dedektörleri	66
Döner, flaşör lambaları ve motorlu sirenler	67
Yangın ihbar ürünleri	68
Aspiratör ve sanayi tip vantilatörler	71

aydınlatma grubu

Led Paneller	76
Led Etanj Armatürler	79
Wallwasher - Led Bar Armatürler	80
Radar Sensörlü Armatürler	82
Sıvaaltı / Sıvaüstü T5 Lambalı Armatür	84
Sıvaaltı / Sıvaüstü T8 Lambalı Armatür	84
Etanj Armatür	84
İthal Projektörler	84
Armatür Çeşitleri	85
Nemliyer Armatür Çeşitleri	86
Cam Armatür Çeşitleri	91
Sensörlü Armatür Çeşitleri	92
Bahçe Armatürleri	96
IP68 Park Bahçe Armatürleri	97
IP68 Su Geçirmez Rekorlar	98
Exit - Acil Aydınlatma Armatürü	100

otomasyon grubu

Delikli kablo kanalları	103
Ray Klamensler	104
Raylar, izalatörler ve topraklama çubuğu	104
Kablo bağları ve etiketleri	105
Sıkmalı tip kablo pabuç ve penseleri	106
İzoleli yüksükler ve penseleri	107
Sinyal ve kumanda butonları	108
Vinç kutuları	110
Etanj buton kutuları	111
İkaz lambaları	112
Borulu kornalar	114
Termoplastik buatlar ve kombinasyon kutuları	118
Logar kutuları	120
Plastik opak ve etanj panolar	120
Sanayi tipi kauçuk fiş ve prizleri	122
CEE Norm fiş ve prizler	123
Çoklu grup prizler	125
Seyyar el lambaları ve kablo makaraları	125
Sanayi tipi fiş ve prizleri	125
Reçineli kablo başlıkları	126
Isı ile daralan makarolar	126

New
YENİ

Ritä

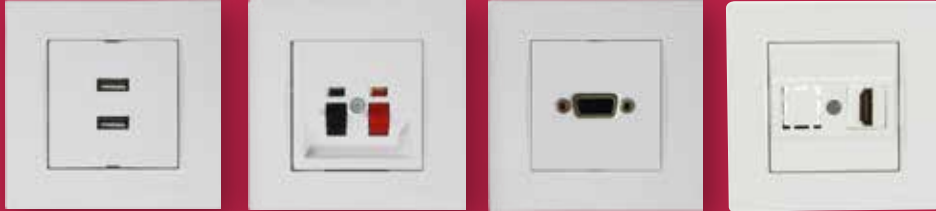

RCA



USB PRINTER



SPEAKPHONE



XLR DIŐI



XLR ERKEK



3,5 SES JAKI



New
YENİ

Yeni ve farklı ürünümüz

Ritä pastel



ISO 9001:2008



www.mutlusan.com.tr

Kod	Ürün Tanımı	Kutu Adedi	Koli Adedi	Fiyat
-----	-------------	------------	------------	-------

Anahtar Grubu Vidalı Tip

2200 401 02XX	Rita Mek+Tuş Anahtar (Vidalı)	12	120	5,977
2200 402 02XX	Rita Mek+Tuş Komütatör (Vidalı)	12	120	8,382
2200 403 02XX	Rita Mek+Tuş Vavien (İki Yollu Anahtar)(Vidalı)	12	120	9,030
2200 404 02XX	Rita Mek+Tuş Komütatör Vavien (Vidalı)	12	120	14,311
2200 405 02XX	Rita Mek+Tuş Çift Kutuplu Anahtar (Vidalı)	12	120	9,541
2200 406 02XX	Rita Mek+Tuş Jaluzi Anahtarı (Vidalı)	12	120	13,630
2200 407 02XX	Rita Mek+Tuş Çağırma (Vidalı)	12	120	8,689
2200 407 02XXK	Rita Mek+Tuş Kapı Otomatığı Anahtarı (Vidalı)	12	120	8,689
2200 407 02XXZ	Rita Mek+Tuş Zil Anahtarı (Vidalı)	12	120	8,689
2200 408 02XX	Rita Mek+Tuş Deviatör(Ara Vavien)(Vidalı)	12	120	13,221
2200 409 02XX	Rita Mek+Tuş Üçlü Anahtar (Vidalı)	12	120	12,778
2200 411 02XX	Rita Mek+Tuş Şofben Anahtarı (Vidalı)	12	120	9,226
2200 415 02XX	Rita Mek+Tuş Işıklı Anahtar (220V) (Vidalı)	12	120	12,800
2200 416 02XX	Rita Mek+Tuş Işıklı Vavien (220V) (Vidalı)	12	120	15,111
2200 417 02XX	Rita Mek+Tuş Işıklı Çağırma (220V)(Vidalı)	12	120	13,156
2200 418 02XX	Rita Mek+Tuş Işıklı Etik. Anahtar (220V)(Vidalı)	12	120	13,889
2200 419 02XX	Rita Mek+Tuş Işıklı Etik. Çağırma (220V)(Vidalı)	12	120	14,074
2200 422 02XX	Rita Mek+Tuş Işıklı Zil Etik. Çağırma (12V)(Vidalı)	12	120	12,369
2200 426 02XX	Rita Mek+Tuş Işıklı Komütatör (Vidalı)	12	120	16,711

Anahtar Grubu Klipsli Tip (Kolay Bağlantı)

2200 401 01XX	Rita Mek+Tuş Anahtar (Klipsli)	12	120	5,977
2200 402 01XX	Rita Mek+Tuş Komütatör (Klipsli)	12	120	8,382
2200 403 01XX	Rita Mek+Tuş Vavien (İki Yollu Anahtar)(Klipsli)	12	120	9,030
2200 404 01XX	Rita Mek+Tuş Komütatör Vavien (Klipsli)	12	120	14,311
2200 405 01XX	Rita Mek+Tuş Çift Kutuplu Anahtar (Klipsli)	12	120	9,541
2200 406 01XX	Rita Mek+Tuş Jaluzi Anahtarı (Klipsli)	12	120	13,630
2200 407 01XX	Rita Mek+Tuş Çağırma (Klipsli)	12	120	8,689
2200 407 01XXK	Rita Mek+Tuş Kapı Otomatığı Anahtarı(Klipsli)	12	120	8,689
2200 407 01XXZ	Rita Mek+Tuş Zil Anahtarı(Klipsli)	12	120	8,689
2200 408 01XX	Rita Mek+Tuş Deviatör(Ara Vavien)(Klipsli)	12	120	13,221
2200 409 01XX	Rita Mek+Tuş Üçlü Anahtar (Klipsli)	12	120	12,778
2200 415 01XX	Rita Mek+Tuş Işıklı Anahtar (220V) (Klipsli)	12	120	12,800
2200 416 01XX	Rita Mek+Tuş Işıklı Vavien (220V) (Klipsli)	12	120	15,111
2200 417 01XX	Rita Mek+Tuş Işıklı Çağırma (220V)(Klipsli)	12	120	13,156
2200 418 01XX	Rita Mek+Tuş Işıklı Etik. Anahtar (220V)(Klipsli)	12	120	13,889
2200 419 01XX	Rita Mek+Tuş Işıklı Etik. Çağırma (220V)(Klipsli)	12	120	14,074
2200 422 01XX	Rita Mek+Tuş Işıklı Zil Etik. Çağırma (12V)(Klipsli)	12	120	12,369
2200 426 01XX	Rita Mek+Tuş Işıklı Komütatör (Klipsli)	12	120	16,711

Dimmer Grubu

2200 440 02XX	Rita Mek+Tuş RL Işıklı Dimmer 600W	8	80	57,004
2200 444 02XX	Rita Mek+Tuş RL Işıklı Dimmer 1000W	8	80	71,556

Elektronik Grubu

2200 450 01XX	Rita Mek+Tuş Energy Saver G.siz Işıklı	8	80	81,778
2200 452 01XX	Rita Mek+Tuş Energy Saver Gecikmeli Işıklı	8	80	81,773
2200 470 02XX	Rita Mek+Tuş Müzik Yayın Anahtarı	8	80	65,778
2200 480 01XX	Rita Mek+Tuş Hoparlör Prizi	8	80	11,500
2200 485 02XX	Rita Mek+Tuş Uyarı Zili	8	80	51,556
2200 495 02XX	Rita Mek+Tuş Hareket Sensörü	8	80	99,556

Priz Grubu

2200 600 02XX	Rita Mek+Tuş Topraklı Priz	12	120	7,496
2200 601 02XX	Rita Mek+Tuş Topraksız Priz	12	120	6,713
2200 605 02XX	Rita Mek+Tuş Topraklı Priz (Çocuk Kor.)	12	120	9,881
2200 606 02XX	Rita Mek+Tuş Topraksız Priz (Çocuk Kor.)	12	120	8,689
2200 610 02XX	Rita Mek+Tuş Kapaklı Topraklı Priz	12	120	9,200
2200 611 02XX	Rita Mek+Tuş Kapaklı Topraklı Priz (Çoc. Kor.)	12	120	11,585
2200 615 02XX	Rita Mek+Tuş Ups (Fransız) Prizi	12	120	9,200
2200 616 02XX	Rita Mek+Tuş Ups (Fransız) Prizi (Çoc. Kor.)	12	120	10,972
2200 617 02XX	Rita Mek+Tuş Ups Kapaklı (Fransız) Priz	12	120	11,170
2200 618 02XX	Rita Mek+Tuş Ups Kapaklı (Fr.) Priz (Çoc. Kor.)	12	120	11,415
2200 200 02XX	Rita Mek+Tuş İkili Topraklı Priz Porselen	5	120	13,109
2200 201 02XX	Rita Mek+Tuş İkili Topraksız Priz Porselen	5	50	10,873
2200 202 02XX	Rita Mek+Tuş İkili Topraklı Priz	5	50	11,681
2200 203 02XX	Rita Mek+Tuş İkili Topraksız Priz	5	50	9,329
2200 215 01XX	Rita Mek+Tuş İkili Ups Priz	5	50	13,804
2200 448 01XX	Rita Mek+Tuş Tekli Usb Şarj Prizi	5	50	67,706
2200 449 01XX	Rita Mek+Tuş İkili Usb Şarj Prizi	5	50	69,284

Kod	Ürün Tanımı	Kutu Adedi	Koli Adedi	Fiyat
İletişim Grubu				
2200 125 01XX	Rita Mek+Tuş Telefon Prizi 1Xrj12 (Cat3)	12	120	11,415
2200 126 01XX	Rita Mek+Tuş Telefon Prizi 2Xrj12 (Cat3)	12	120	15,844
2200 128 01XX	Rita Mek+Tuş Etiketli Tlf Data Priz (Kon.süz)	12	120	7,111
2200 135 02XX	Rita Mek+Tuş Data Prizi 1 *Rj45 (Kon.süz)	12	120	6,474
2200 136 01XX	Rita Mek+Tuş Data Prizi 1 *Rj45 (Cat5e)	12	120	18,741
2200 137 01XX	Rita Mek+Tuş Data Prizi 2 *Rj45 (Kon.süz)	12	120	7,150
2200 138 01XX	Rita Mek+Tuş Data Prizi 2 *Rj45 (Cat5e)	12	120	30,667
2200 139 01XX	Rita Mek+Tuş Tlf Data Priz (Rj12 Cat3 + Cat5e)	12	120	24,874
2200 140 01XX	Rita Mek+Tuş Data Prizi 1 *Rj45 (Cat6)	12	120	20,632
2200 141 01XX	Rita Mek+Tuş Data Prizi 2 *Rj45 (Cat6)	12	120	37,190
2200 455 01XX	Rita Mek+Tuş Data Prizi 1 *Usb	12	120	28,278
2200 456 01XX	Rita Mek+Tuş Data Prizi 2 *Usb	12	120	49,313
2200 457 01XX	Rita Mek+Tuş Data Prizi 1 *Hdmi	12	120	35,431
2200 458 01XX	Rita Mek+Tuş Data Prizi 2 *Hdmi	12	120	63,258
2200 459 01XX	Rita Mek+Tuş Data Prizi 1 *Usb/1 *Hdmi	12	120	55,339
2200 460 01XX	Rita Mek+Tuş VGA Priz	12	120	55,200
2200 121 02XX	Rita Mek+Tuş Kör Kapak	12	120	6,133

TV / Sat Grubu

2200 156 02XX	Rita Mek+Tuş Tv-Sat Prizi (Geçişli) 4DB/F Kon.	12	120	47,805
2200 157 02XX	Rita Mek+Tuş Tv-Sat Prizi (Sonlu)	12	120	47,805
2200 166 01XX	Rita Mek+Tuş Sat Prizi (Geçişli) 4DB/F Kon.	12	120	23,852
2200 167 01XX	Rita Mek+Tuş Sat Prizi (Sonlu)	12	120	23,852
2200 170 01XX	Rita Mek+Tuş Tv Prizi (Geçişli) 11DB	12	120	15,048
2200 171 01XX	Rita Mek+Tuş Tv Prizi (Sonlu)	12	120	15,048
2200 172 01XX	Rita Mek+Tuş Tv Prizi F Dişi	12	120	9,030

Çerçeveler

2220 800 11XX	Rita Tekli Çerçeve	20	400	1,244
2220 800 12XX	Rita İkili Yatay Çerçeve	10	200	3,874
2220 800 13XX	Rita Üçlü Yatay Çerçeve	10	50	4,978
2220 800 14XX	Rita Dörtlü Yatay Çerçeve	10	50	6,139
2220 800 15XX	Rita Beşli Yatay Çerçeve	10	50	7,799
2220 800 16XX	Rita Altılı Yatay Çerçeve	10	50	10,287
2220 800 22XX	Rita İkili Dikey Çerçeve	10	50	3,874
2220 800 23XX	Rita Üçlü Dikey Çerçeve	10	50	4,978
2220 800 24XX	Rita Dörtlü Dikey Çerçeve	10	50	6,139
2220 800 25XX	Rita Beşli Dikey Çerçeve	10	50	7,799
2220 800 26XX	Rita Altılı Dikey Çerçeve	10	50	10,287
2220 820 12XX	Rita İkili Priz Çerçeve	12	60	2,367

► RİTA PASTEL
Çerçeveler

2220 800 11XX	Rita Tekli Çerçeve	20	400	2,369
2220 800 12XX	Rita İkili Yatay Çerçeve	10	200	7,372
2220 800 13XX	Rita Üçlü Yatay Çerçeve	10	50	9,465
2220 800 14XX	Rita Dörtlü Yatay Çerçeve	10	50	11,673
2220 800 15XX	Rita Beşli Yatay Çerçeve	10	50	14,824
2220 800 16XX	Rita Altılı Yatay Çerçeve	10	50	19,562
2220 800 22XX	Rita İkili Dikey Çerçeve	10	50	7,372
2220 800 23XX	Rita Üçlü Dikey Çerçeve	10	50	9,465
2220 800 24XX	Rita Dörtlü Dikey Çerçeve	10	50	11,673
2220 800 25XX	Rita Beşli Dikey Çerçeve	10	50	14,824
2220 800 26XX	Rita Altılı Dikey Çerçeve	10	50	19,562
2100 000 11XX	Sıva Üstü Kasa	12	60	4,050

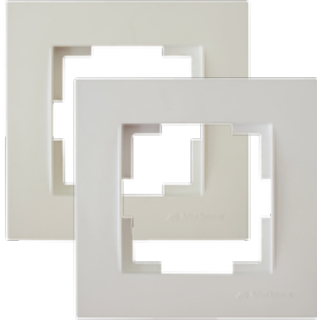

01 Beyaz
02 Krem



Kirmızı
04



Turuncu
06



Sarı
08

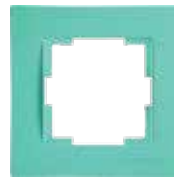

Yeşil
10

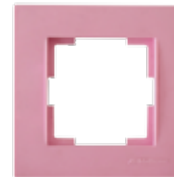

Pembe
11



Mavi
12



Mor
25

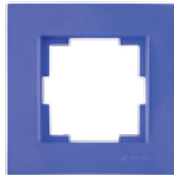

Lacivert
09



Gri
03

Kod	Ürün Tanımı	Kutu Adedi	Koli Adedi	Fiyat
-----	-------------	------------	------------	-------

Anahtar Grubu Vidalı Tip

2200 401 02XX	Rita Mek+Tuş Anahtar (Vidalı)	12	120	9,881
2200 402 02XX	Rita Mek+Tuş Komütatör (Vidalı)	12	120	11,756
2200 403 02XX	Rita Mek+Tuş Vavien (İki Yollu Anahtar)(Vidalı)	12	120	11,653
2200 404 02XX	Rita Mek+Tuş Komütatör Vavien (Vidalı)	12	120	17,195
2200 405 02XX	Rita Mek+Tuş Çift Kutuplu Anahtar (Vidalı)	12	120	11,756
2200 406 02XX	Rita Mek+Tuş Jaluzi Anahtarı (Vidalı)	12	120	17,616
2200 407 02XX	Rita Mek+Tuş Çağırma (Vidalı)	12	120	10,938
2200 407 02XXX	Rita Mek+Tuş Kapı Otomatiği Anahtarı (Vidalı)	12	120	10,938
2200 407 02XXZ	Rita Mek+Tuş Zil Anahtarı (Vidalı)	12	120	10,938
2200 408 02XX	Rita Mek+Tuş Deviatör (Ara Vavien)(Vidalı)	12	120	16,873
2200 409 02XX	Rita Mek+Tuş Üçlü Anahtar (Vidalı)	12	120	17,354
2200 411 02XX	Rita Mek+Tuş Şofben Anahtarı (Vidalı)	12	120	11,993
2200 415 02XX	Rita Mek+Tuş Işıklı Anahtar (220V) (Vidalı)	12	120	15,585
2200 416 02XX	Rita Mek+Tuş Işıklı Vavien (220V) (Vidalı)	12	120	16,693
2200 417 02XX	Rita Mek+Tuş Işıklı Çağırma (220V)(Vidalı)	12	120	17,066
2200 418 02XX	Rita Mek+Tuş Işıklı Etik. Anahtar (220V)(Vidalı)	12	120	15,289
2200 419 02XX	Rita Mek+Tuş Işıklı Etik. Çağırma (220V)(Vidalı)	12	120	15,289
2200 422 02XX	Rita Mek+Tuş Işıklı Zil Etik. Çağırma (12V)(Vidalı)	12	120	14,652
2200 426 02XX	Rita Mek+Tuş Işıklı Komütatör (Vidalı)	12	120	19,292

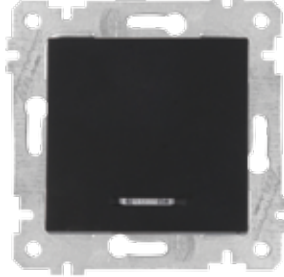

Anahtar Grubu Klipsli Tip (Kolay Bağlantı)

2200 401 01XX	Rita Mek+Tuş Anahtar (Klipsli)	12	120	9,881
2200 402 01XX	Rita Mek+Tuş Komütatör (Klipsli)	12	120	11,756
2200 403 01XX	Rita Mek+Tuş Vavien (İki Yollu Anahtar)(Klipsli)	12	120	11,653
2200 404 01XX	Rita Mek+Tuş Komütatör Vavien (Klipsli)	12	120	17,195
2200 405 01XX	Rita Mek+Tuş Çift Kutuplu Anahtar (Klipsli)	12	120	11,756
2200 406 01XX	Rita Mek+Tuş Jaluzi Anahtarı (Klipsli)	12	120	17,616
2200 407 01XX	Rita Mek+Tuş Çağırma (Klipsli)	12	120	10,938
2200 407 01XXX	Rita Mek+Tuş Kapı Otomatiği Anahtarı(Klipsli)	12	120	10,938
2200 407 01XXZ	Rita Mek+Tuş Zil Anahtarı(Klipsli)	12	120	10,938
2200 408 01XX	Rita Mek+Tuş Deviatör (Ara Vavien)(Klipsli)	12	120	16,873
2200 409 01XX	Rita Mek+Tuş Üçlü Anahtar (Klipsli)	12	120	17,354
2200 415 01XX	Rita Mek+Tuş Işıklı Anahtar (220V) (Klipsli)	12	120	15,585
2200 416 01XX	Rita Mek+Tuş Işıklı Vavien (220V) (Klipsli)	12	120	16,693
2200 417 01XX	Rita Mek+Tuş Işıklı Çağırma (220V)(Klipsli)	12	120	17,066
2200 418 01XX	Rita Mek+Tuş Işıklı Etik. Anahtar (220V)(Klipsli)	12	120	15,289
2200 419 01XX	Rita Mek+Tuş Işıklı Etik. Çağırma (220V)(Klipsli)	12	120	15,289
2200 422 01XX	Rita Mek+Tuş Işıklı Zil Etik. Çağırma (12V)(Klipsli)	12	120	14,652
2200 426 01XX	Rita Mek+Tuş Işıklı Komütatör (Klipsli)	12	120	19,292

Dimmer Grubu

2200 440 02XX	Rita Mek+Tuş RL Işıklı Dimmer 600W	8	80	58,562
2200 444 02XX	Rita Mek+Tuş RI Işıklı Dimmer 1000W	8	80	73,735

Elektronik Grubu

2200 450 01XX	Rita Mek+Tuş Energy Saver G.siz Işıklı	8	80	84,433
2200 452 01XX	Rita Mek+Tuş Energy Saver Gecikmeli Işıklı	8	80	84,436
2200 470 02XX	Rita Mek+Tuş Müzik Yayın Anahtarı	8	80	71,778
2200 480 01XX	Rita Mek+Tuş Hoparlör Prizi	12	120	31,559
2200 485 02XX	Rita Mek+Tuş Uyarı Zili	12	120	56,124
2200 495 02XX	Rita Mek+Tuş Hareket Sensörü	12	120	110,741

Priz Grubu

2200 600 02XX	Rita Mek+Tuş Topraklı Priz	12	120	11,209
2200 601 02XX	Rita Mek+Tuş Topraksız Priz	12	120	9,951
2200 605 02XX	Rita Mek+Tuş Topraklı Priz (Çocuk Kor.)	12	120	15,169
2200 606 02XX	Rita Mek+Tuş Topraksız Priz (Çocuk Kor.)	12	120	13,276
2200 610 02XX	Rita Mek+Tuş Kapaklı Topraklı Priz	12	120	12,338
2200 611 02XX	Rita Mek+Tuş Kapaklı Topraklı Priz (Çoc. Kor.)	12	120	17,505
2200 615 02XX	Rita Mek+Tuş Ups (Fransız) Prizi	12	120	16,015
2200 616 02XX	Rita Mek+Tuş Ups (Fransız) Prizi (Çocuk Kor.)	12	120	17,617
2200 617 02XX	Rita Mek+Tuş Ups Kapaklı (Fransız) Priz	12	120	18,827
2200 618 02XX	Rita Mek+Tuş Ups Kapaklı (Fr.) Priz (Çoc. Kor.)	12	120	20,969
2200 200 02XX	Rita Mek+Tuş İkili Topraklı Priz Porselen	5	50	16,476
2200 201 02XX	Rita Mek+Tuş İkili Topraksız Priz Porselen	5	50	15,333
2200 202 02XX	Rita Mek+Tuş İkili Topraklı Priz	5	50	14,822
2200 203 02XX	Rita Mek+Tuş İkili Topraksız Priz	5	50	11,926
2200 215 02XX	Rita Mek+Tuş İkili Ups Priz	5	50	17,037
2200 448 01XX	Rita Mek+Tuş Tekli Usb Şarj Prizi	5	50	74,750
2200 449 01XX	Rita Mek+Tuş İkili Usb Şarj Prizi	5	50	76,878

Metalik Mekanizma + Tuş Ürün Listesi
ANTİK ALTIN-80/INOX-82/TİTANYUM-83/SİYAH-84/FÜME-95
Rita Metalik

Kod	Ürün Tanımı	Kutu Adedi	Koli Adedi	Fiyat
İletişim Grubu				
2200 125 01XX	Rita Mek+Tuş Telefon Prizi 1Xrj12 (Cat3)	12	120	13,630
2200 126 01XX	Rita Mek+Tuş Telefon Prizi 2Xrj12 (Cat3)	12	120	20,104
2200 128 01XX	Rita Mek+Tuş Etiketli Tlf Data Priz (Kon.süz)	12	120	9,466
2200 135 02XX	Rita Mek+Tuş Data Prizi 1 *Rj45 (Kon.süz)	12	120	9,021
2200 136 01XX	Rita Mek+Tuş Data Prizi 1 *Rj45 (Cat5e)	12	120	28,622
2200 137 01XX	Rita Mek+Tuş Data Prizi 2 *Rj45 (Kon.süz)	12	120	9,030
2200 138 01XX	Rita Mek+Tuş Data Prizi 2 *Rj45 (Cat5e)	12	120	44,978
2200 139 01XX	Rita Mek+Tuş Tlf Data Prizi (Rj12 Cat3 + Cat5e)	12	120	39,391
2200 140 01XX	Rita Mek+Tuş Data Prizi 1 *Rj45 (Cat6)	12	120	28,622
2200 141 01XX	Rita Mek+Tuş Data Prizi 2 *Rj45 (Cat6)	12	120	44,978
2200 455 01XX	Rita Mek+Tuş Data Prizi 1 *Usb	12	120	28,452
2200 456 01XX	Rita Mek+Tuş Data Prizi 2 *Usb	12	120	48,460
2200 457 01XX	Rita Mek+Tuş Data Prizi 1 *Hdmi	12	120	35,778
2200 458 01XX	Rita Mek+Tuş Data Prizi 2 *Hdmi	12	120	62,718
2200 459 01XX	Rita Mek+Tuş Data Prizi 1 *Usb/1 *Hdmi	12	120	55,067
2200 460 01XX	Rita Mek+Tuş VGA Priz	12	120	94,645
2200 121 02XX	Rita Mek+Tuş Kör Kapak	12	120	13,942

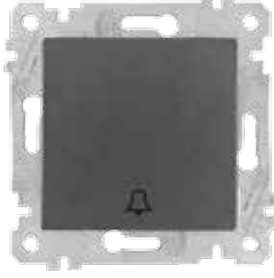
TV / Sat Grubu

2200 156 02XX	Rita Mek+Tuş Tv-Sat Prizi (Geçişli) 4DB/F Kon.	12	120	55,556
2200 157 02XX	Rita Mek+Tuş Tv-Sat Prizi (Sonlu)	12	120	55,556
2200 166 01XX	Rita Mek+Tuş Sat Prizi (Geçişli) 4DB/F Kon.	12	120	29,889
2200 167 01XX	Rita Mek+Tuş Sat Prizi (Sonlu)	12	120	29,889
2200 170 01XX	Rita Mek+Tuş Tv Prizi (Geçişli) 11DB	12	120	16,904
2200 171 01XX	Rita Mek+Tuş Tv Prizi (Sonlu)	12	120	16,904
2200 172 01XX	Rita Mek+Tuş Tv Prizi F Dişi	12	120	9,200

Çerçeveler

2220 800 11XX	Rita Tekli Çerçeve	20	400	2,675
2220 800 12XX	Rita İkili Yatay Çerçeve	10	200	4,941
2220 800 13XX	Rita Üçlü Yatay Çerçeve	10	50	9,849
2220 800 14XX	Rita Dörtlü Yatay Çerçeve	10	50	12,370
2220 800 15XX	Rita Beşli Yatay Çerçeve	10	50	15,900
2220 800 16XX	Rita Altılı Yatay Çerçeve	10	50	20,931
2220 800 22XX	Rita İkili Dikey Çerçeve	10	50	4,941
2220 800 23XX	Rita Üçlü Dikey Çerçeve	10	50	9,849
2220 800 24XX	Rita Dörtlü Dikey Çerçeve	10	50	12,370
2220 800 25XX	Rita Beşli Dikey Çerçeve	10	50	15,900
2220 800 26XX	Rita Altılı Dikey Çerçeve	10	50	20,931
2100 000 11XX	Sıva Üstü Kasa	12	60	6,729
2220 820 12XX	Rita İkili Priz Çerçeve	12	60	4,430

A. Altın
80

Inox
82

Titanyum
83

Siyah
84

Füme
95

Rita Ahşap

Ahşap Mekanizma + Tuş Ürün Listesi

KİRAZ-56 / CEVİZ-57 / MEŞE-58

Kod	Ürün Tanımı	Kutu Adedi	Koli Adedi	Fiyat
-----	-------------	------------	------------	-------

Anahtar Grubu Vidalı Tip



2200 401 02XX	Rita Mek+Tuş Anahtar (Vidalı)	12	120	10,376
2200 402 02XX	Rita Mek+Tuş Komütatör (Vidalı)	12	120	12,343
2200 403 02XX	Rita Mek+Tuş Vavien (İki Yollu Anahtar)(Vidalı)	12	120	12,236
2200 404 02XX	Rita Mek+Tuş Komütatör Vavien (Vidalı)	12	120	18,055
2200 405 02XX	Rita Mek+Tuş Çift Kutuplu Anahtar (Vidalı)	12	120	12,343
2200 406 02XX	Rita Mek+Tuş Jaluzi Anahtarı (Vidalı)	12	120	18,497
2200 407 02XX	Rita Mek+Tuş Çağırma (Vidalı)	12	120	11,485
2200 407 02XXX	Rita Mek+Tuş Kapı Otomatığı Anahtarı (Vidalı)	12	120	11,485
2200 407 02XXZ	Rita Mek+Tuş Zil Anahtarı (Vidalı)	12	120	11,485
2200 408 02XX	Rita Mek+Tuş Deviatör(Ara Vavien)(Vidalı)	12	120	17,717
2200 409 02XX	Rita Mek+Tuş Üçlü Anahtar (Vidalı)	12	120	18,222
2200 411 02XX	Rita Mek+Tuş Şofben Anahtarı (Vidalı)	12	120	12,593
2200 415 02XX	Rita Mek+Tuş Işıklı Anahtar (220V) (Vidalı)	12	120	16,364
2200 416 02XX	Rita Mek+Tuş Işıklı Vavien (220V) (Vidalı)	12	120	17,527
2200 417 02XX	Rita Mek+Tuş Işıklı Çağırma (220V)(Vidalı)	12	120	17,919
2200 418 02XX	Rita Mek+Tuş Işıklı Etik Anahtar (220V)(Vidalı)	12	120	16,722
2200 419 02XX	Rita Mek+Tuş Işıklı Etik Çağırma (220V)(Vidalı)	12	120	16,722
2200 422 02XX	Rita Mek+Tuş Işıklı Zil Etik Çağırma (12V)(Vidalı)	12	120	15,384
2200 426 02XX	Rita Mek+Tuş Işıklı Komütatör (Vidalı)	12	120	20,893

Anahtar Grubu Klipsli Tip (Kolay Bağlantı)



2200 401 01XX	Rita Mek+Tuş Anahtar (Klipsli)	12	120	10,376
2200 402 01XX	Rita Mek+Tuş Komütatör (Klipsli)	12	120	12,343
2200 403 01XX	Rita Mek+Tuş Vavien (İki Yollu Anahtar)(Klipsli)	12	120	12,236
2200 404 01XX	Rita Mek+Tuş Komütatör Vavien (Klipsli)	12	120	18,055
2200 405 01XX	Rita Mek+Tuş Çift Kutuplu Anahtar (Klipsli)	12	120	12,343
2200 406 01XX	Rita Mek+Tuş Jaluzi Anahtarı (Klipsli)	12	120	18,497
2200 407 01XX	Rita Mek+Tuş Çağırma (Klipsli)	12	120	11,485
2200 407 01XXX	Rita Mek+Tuş Kapı Otomatığı Anahtarı(Klipsli)	12	120	11,485
2200 407 01XXZ	Rita Mek+Tuş Zil Anahtarı(Klipsli)	12	120	11,485
2200 408 01XX	Rita Mek+Tuş Deviatör(Ara Vavien)(Klipsli)	12	120	17,717
2200 409 01XX	Rita Mek+Tuş Üçlü Anahtar (Klipsli)	12	120	18,222
2200 415 01XX	Rita Mek+Tuş Işıklı Anahtar (220V) (Klipsli)	12	120	16,364
2200 416 01XX	Rita Mek+Tuş Işıklı Vavien (220V) (Klipsli)	12	120	17,527
2200 417 01XX	Rita Mek+Tuş Işıklı Çağırma (220V)(Klipsli)	12	120	17,919
2200 418 01XX	Rita Mek+Tuş Işıklı Etik Anahtar (220V)(Klipsli)	12	120	16,722
2200 419 01XX	Rita Mek+Tuş Işıklı Etik Çağırma (220V)(Klipsli)	12	120	16,722
2200 422 01XX	Rita Mek+Tuş Işıklı Zil Etik Çağırma (12V)(Klipsli)	12	120	15,384
2200 426 01XX	Rita Mek+Tuş Işıklı Komütatör (Klipsli)	12	120	20,893

Dimmer Grubu



2200 440 02XX	Rita Mek+Tuş RL Işıklı Dimmer 600W	8	80	61,490
2200 444 02XX	Rita Mek+Tuş RI Işıklı Dimmer 1000W	8	80	77,422

Elektronik Grubu

2200 450 01XX	Rita Mek+Tuş Energy Saver G.siz Işıklı	8	80	88,655
2200 452 01XX	Rita Mek+Tuş Energy Saver Gecikmeli Işıklı	8	80	90,666
2200 470 02XX	Rita Mek+Tuş Müzik Yayın Anahtarı	8	80	75,367
2200 480 01XX	Rita Mek+Tuş Hoparlör Prizi	12	120	33,136
2200 485 02XX	Rita Mek+Tuş Uyarı Zili	12	120	58,931
2200 495 02XX	Rita Mek+Tuş Hareket Sensörü	10	120	116,278

Priz Grubu

2200 600 02XX	Rita Mek+Tuş Topraklı Priz	12	120	11,769
2200 601 02XX	Rita Mek+Tuş Topraksız Priz	12	120	10,449
2200 605 02XX	Rita Mek+Tuş Topraklı Priz (Çocuk Kor.)	12	120	17,719
2200 606 02XX	Rita Mek+Tuş Topraksız Priz (Çocuk Kor.)	12	120	15,538
2200 610 02XX	Rita Mek+Tuş Kapaklı Topraklı Priz	12	120	12,955
2200 611 02XX	Rita Mek+Tuş Kapaklı Topraklı Priz (Çoc. Kor.)	12	120	18,666
2200 615 02XX	Rita Mek+Tuş Ups (Fransız) Prizi	12	120	16,816
2200 616 02XX	Rita Mek+Tuş Ups (Fransız) Prizi (Çoc. Kor.)	12	120	18,498
2200 617 02XX	Rita Mek+Tuş Ups Kapaklı (Fransız) Priz	12	120	19,768
2200 618 02XX	Rita Mek+Tuş Ups Kapaklı (Fr.) Priz (Çoc. Kor.)	12	120	22,017
2200 200 02XX	Rita Mek+Tuş İkili Topraklı Priz Porselen	5	120	17,620
2200 201 02XX	Rita Mek+Tuş İkili Topraksız Priz Porselen	5	50	16,377
2220 202 02XX	Rita Mek+Tuş İkili Topraklı Priz	5	50	15,563
2200 203 02XX	Rita Mek+Tuş İkili Topraksız Priz	5	50	12,522
2200 215 02XX	Rita Mek+Tuş İkili Ups Priz	5	50	17,889
2200 448 01XX	Rita Mek+Tuş Tekli Usb Şarj Prizi	5	50	84,755
2200 449 01XX	Rita Mek+Tuş İkili Usb Şarj Prizi	5	50	87,170

Kod	Ürün Tanımı	Kutu Adedi	Koli Adedi	Fiyat
-----	-------------	------------	------------	-------

İletişim Grubu

2200 125 01XX	Rita Mek+Tuş Telefon Prizi 1Xrj12 (Cat3)	12	120	14,857
2200 126 01XX	Rita Mek+Tuş Telefon Prizi 2Xrj12 (Cat3)	12	120	21,109
2200 128 01XX	Rita Mek+Tuş Etiketli Tlf Data Priz (Kon.süz)	12	120	11,762
2200 135 02XX	Rita Mek+Tuş Data Prizi 1*Rj45 (Kon.süz)	12	120	11,756
2200 136 01XX	Rita Mek+Tuş Data Prizi 1*Rj45 (Cat5e)	12	120	30,053
2200 137 01XX	Rita Mek+Tuş Data Prizi 2*Rj45 (Kon.süz)	12	120	11,756
2200 138 01XX	Rita Mek+Tuş Data Prizi 2*Rj45 (Cat5e)	12	120	47,227
2200 139 01XX	Rita Mek+Tuş Tlf Data Priz (Rj12 Cat3 + Cat5e)	12	120	41,361
2200 140 01XX	Rita Mek+Tuş Data Prizi 1*Rj45 (Cat6)	12	120	30,053
2200 141 01XX	Rita Mek+Tuş Data Prizi 2*Rj45 (Cat6)	12	120	47,227
2200 455 01XX	Rita Mek+Tuş Data Prizi 1*Usb	12	120	29,874
2200 456 01XX	Rita Mek+Tuş Data Prizi 2*Usb	12	120	50,883
2200 457 01XX	Rita Mek+Tuş Data Prizi 1*Hdmı	12	120	37,567
2200 458 01XX	Rita Mek+Tuş Data Prizi 2*Hdmı	12	120	65,854
2200 459 01XX	Rita Mek+Tuş Data Prizi 1*Usb/1*Hdmı	12	120	57,821
2200 460 01XX	Rita Mek+Tuş VGA Prizi	12	120	106,950
2200 121 02XX	Rita Mek+Tuş Kör Kapak	12	120	14,639

TV / Sat Grubu

2200 156 02XX	Rita Mek+Tuş Tv-Sat Prizi (Geçişli) 4DB/F Kon.	12	120	58,333
2200 157 02XX	Rita Mek+Tuş Tv-Sat Prizi (Sonlu)	12	120	58,333
2200 166 01XX	Rita Mek+Tuş Sat Prizi (Geçişli) 4DB/F Kon.	12	120	31,377
2200 167 01XX	Rita Mek+Tuş Sat Prizi (Sonlu)	12	120	31,377
2200 170 01XX	Rita Mek+Tuş Tv Prizi (Geçişli) 11DB	12	120	17,749
2200 171 01XX	Rita Mek+Tuş Tv Prizi (Sonlu)	12	120	17,749
2200 172 01XX	Rita Mek+Tuş Tv Prizi F Dişli	12	120	11,381

Çerçeveseler

2220 800 11XX	Rita Tekli Çerçeve	20	400	4,945
2220 800 12XX	Rita İkili Yatay Çerçeve	10	200	8,924
2220 800 13XX	Rita Üçlü Yatay Çerçeve	10	50	12,064
2220 800 14XX	Rita Dörtlü Yatay Çerçeve	10	50	15,330
2220 800 15XX	Rita Beşli Yatay Çerçeve	10	50	17,204
2220 800 16XX	Rita Altılı Yatay Çerçeve	10	50	23,104
2220 800 22XX	Rita İkili Dikey Çerçeve	10	50	8,924
2220 800 23XX	Rita Üçlü Dikey Çerçeve	10	50	12,064
2220 800 24XX	Rita Dörtlü Dikey Çerçeve	10	50	15,330
2220 800 25XX	Rita Beşli Dikey Çerçeve	10	50	17,204
2220 800 26XX	Rita Altılı Dikey Çerçeve	10	50	23,104
2100 000 11XX	Sıva Üstü Kasa	12	60	7,769
2220 820 12XX	Rita İkili Priz Çerçeve	12	60	8,348

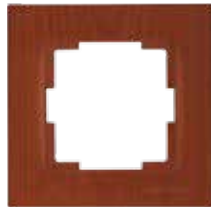
 Kiraz
56

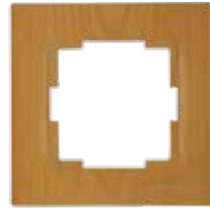
 Ceviz
57

 Meşe
58



Elitra | Plus



RITA NEMLIYER OLIMPIA LIVA FIS PRIZLER
BRON ELITRA PLUS
LIVA FIS PRIZLER
OLIMPIA LIVA FIS PRIZLER
NEMLIYER

ELITRA
ANDELA
RITA DA
BRON

Elitra | Plus

Elitra Glass



XXX-811

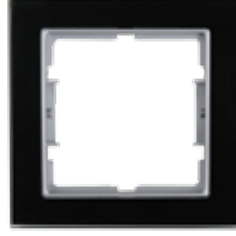

XXX-814



► BEYAZ / SİYAH

Kod	Ürün Tanımı	Kutu Adedi	Fiyat
2170 XXX 11XX	Tekli Çerçeve	10	48,425
2170 XXX 12XX	Yatay İkili Çerçeve	10	77,645
2170 XXX 13XX	Yatay Üçlü Çerçeve	10	127,206
2170 XXX 14XX	Yatay Dörtlü Çerçeve	10	174,183
2170 XXX 15XX	Yatay Beşli Çerçeve	10	214,633
2170 XXX 22XX	Dikey İkili Çerçeve	10	77,645
2170 XXX 23XX	Dikey Üçlü Çerçeve	10	127,206
2170 XXX 24XX	Dikey Dörtlü Çerçeve	10	174,183
2170 XXX 25XX	Dikey Beşli Çerçeve	10	214,633

Elitra Chrome



XXX-821

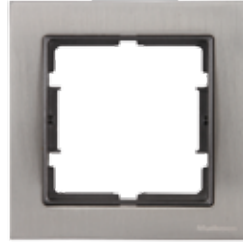

XXX-824

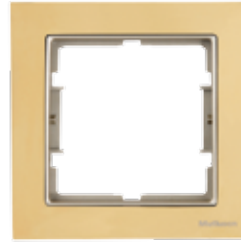

XXX-822

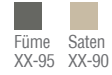

► KROM / PASLANMAZ ÇELİK / ALTIN

Kod	Ürün Tanımı	Kutu Adedi	Fiyat
2170 XXX 11XX	Tekli Çerçeve	10	50,117
2170 XXX 12XX	Yatay İkili Çerçeve	10	99,725
2170 XXX 13XX	Yatay Üçlü Çerçeve	10	145,044
2170 XXX 14XX	Yatay Dörtlü Çerçeve	10	182,892
2170 XXX 15XX	Yatay Beşli Çerçeve	10	324,332
2170 XXX 16XX	Yatay Altılı Çerçeve	10	495,700
2170 XXX 22XX	Dikey İkili Çerçeve	10	99,725
2170 XXX 23XX	Dikey Üçlü Çerçeve	10	145,044
2170 XXX 24XX	Dikey Dörtlü Çerçeve	10	182,892
2170 XXX 25XX	Dikey Beşli Çerçeve	10	324,393
2170 XXX 26XX	Dikey Altılı Çerçeve	10	495,780

Elitra Chrome

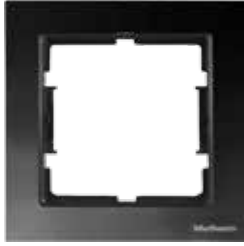

XXX-825

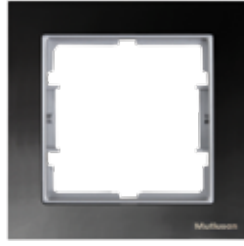

XXX-825

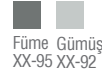
Füme Gümüş
XX-95 XX-92

► GÜMÜŞ - PARLAK FÜME

Kod	Ürün Tanımı	Kutu Adedi	Fiyat
2170 825 11XX	Tekli Çerçeve	10	44,703
2170 825 12XX	Yatay İkili Çerçeve	10	89,264
2170 825 13XX	Yatay Üçlü Çerçeve	10	140,986
2170 825 14XX	Yatay Dörtlü Çerçeve	10	163,342
2170 825 15XX	Yatay Beşli Çerçeve	10	284,306
2170 825 16XX	Yatay Altılı Çerçeve	10	390,632
2170 825 22XX	Dikey İkili Çerçeve	10	89,264
2170 825 23XX	Dikey Üçlü Çerçeve	10	140,986
2170 825 24XX	Dikey Dörtlü Çerçeve	10	163,342
2170 825 25XX	Dikey Beşli Çerçeve	10	284,306
2170 825 26XX	Dikey Altılı Çerçeve	10	390,632

Elitra Chrome



XXX-827



XXX-828

Füme Saten
XX-95 XX-90

► MAT ALÜMİNYUM - MAT SATEN

Kod	Ürün Tanımı	Kutu Adedi	Fiyat
2170 XXX 11XX	Tekli Çerçeve	10	32,787
2170 XXX 12XX	Yatay İkili Çerçeve	10	64,167
2170 XXX 13XX	Yatay Üçlü Çerçeve	10	87,724
2170 XXX 14XX	Yatay Dörtlü Çerçeve	10	117,444
2170 XXX 15XX	Yatay Beşli Çerçeve	10	235,608
2170 XXX 16XX	Yatay Altılı Çerçeve	10	360,051
2170 XXX 22XX	Dikey İkili Çerçeve	10	64,167
2170 XXX 23XX	Dikey Üçlü Çerçeve	10	87,724
2170 XXX 24XX	Dikey Dörtlü Çerçeve	10	117,444
2170 XXX 25XX	Dikey Beşli Çerçeve	10	235,608
2170 XXX 26XX	Dikey Altılı Çerçeve	10	360,051

Elitra Plus

Elitra Wood



► KAYIN / KIRAZ / VENGE

Kod	Ürün Tanımı	Kutu Adedi	Fiyat
2170 XXX 11XX	Tekli Çerçeve	10	53,759
2170 XXX 12XX	Yatay İkili Çerçeve	10	73,857
2170 XXX 13XX	Yatay Üçlü Çerçeve	10	111,096
2170 XXX 14XX	Yatay Dörtlü Çerçeve	10	147,385
2170 XXX 15XX	Yatay Beşli Çerçeve	10	182,762
2170 XXX 22XX	Dikey İkili Çerçeve	10	73,857
2170 XXX 23XX	Dikey Üçlü Çerçeve	10	111,096
2170 XXX 24XX	Dikey Dörtlü Çerçeve	10	147,385
2170 XXX 25XX	Dikey Beşli Çerçeve	10	182,762

Elitra Marble



► BLACK QUARTZ / SAND STONE

Kod	Ürün Tanımı	Kutu Adedi	Fiyat
2170 XXX 11XX	Tekli Çerçeve	10	69,208
2170 XXX 12XX	Yatay İkili Çerçeve	10	93,791
2170 XXX 13XX	Yatay Üçlü Çerçeve	10	137,524
2170 XXX 14XX	Yatay Dörtlü Çerçeve	10	170,215
2170 XXX 15XX	Yatay Beşli Çerçeve	10	211,056
2170 XXX 22XX	Dikey İkili Çerçeve	10	93,791
2170 XXX 23XX	Dikey Üçlü Çerçeve	10	137,524
2170 XXX 24XX	Dikey Dörtlü Çerçeve	10	170,215
2170 XXX 25XX	Dikey Beşli Çerçeve	10	211,056

Elitra Ale

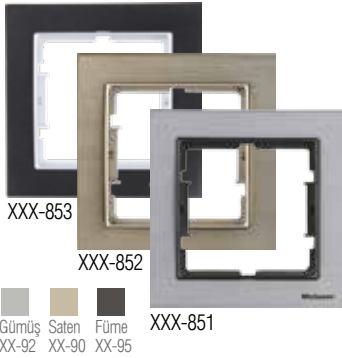

► NATURAL / SATEN / MAT FÜME

Kod	Ürün Tanımı	Kutu Adedi	Fiyat
2170 XXX 11XX	Tekli Çerçeve	10	36,823
2170 XXX 12XX	Yatay İkili Çerçeve	10	68,404
2170 XXX 13XX	Yatay Üçlü Çerçeve	10	99,941
2170 XXX 14XX	Yatay Dörtlü Çerçeve	10	132,294
2170 XXX 15XX	Yatay Beşli Çerçeve	10	164,073
2170 XXX 16XX	Yatay Altılı Çerçeve	10	351,804
2170 XXX 22XX	Dikey İkili Çerçeve	10	68,404
2170 XXX 23XX	Dikey Üçlü Çerçeve	10	99,941
2170 XXX 24XX	Dikey Dörtlü Çerçeve	10	132,294
2170 XXX 25XX	Dikey Beşli Çerçeve	10	164,073
2170 XXX 26XX	Dikey Altılı Çerçeve	10	351,804



Elitra Plus Serisi

Mekanizma + Tuş Ürün Listesi
BEYAZ-01 / SATEN-90 / GÜMÜŞ-92 / FÜME-95

Kod	Ürün Tanıtımı	Kutu Adedi	Fiyat
-----	---------------	------------	-------

Anahtar Grubu Vidalı Tip

2270 401 02XX	Mek+Tuş Anahtar	10	12,437
2270 402 02XX	Mek+Tuş Komütatör	10	13,461
2270 403 02XX	Mek+Tuş Vavien (İki Yollu Anahtar)	10	14,460
2270 404 02XX	Mek+Tuş Komütatör Vavien	10	20,769
2270 405 02XX	Mek+Tuş Çift Kutuplu Anahtar	10	18,130
2270 406 02XX	Mek+Tuş Jaluzi Anahtar-Yaylı	10	21,705
2270 407 02XX	Mek+Tuş Light (Çağırma)	10	12,655
2270 407 02XXZ	Mek+Tuş Zil Anahtarı	10	12,655
2270 407 02XXK	Mek+Tuş Kapı Otomatiği Anahtarı	10	12,655
2270 408 02XX	Mek+Tuş Deviyatör (Ara Vavien)	10	15,965
2270 409 02XX	Mek+Tuş Uçlu Anahtar	10	18,057
2270 411 02XX	Mek+Tuş Şofben Anahtarı	10	13,190
2270 415 02XX	Mek+Tuş Işıklı Anahtar (220V)	10	16,463
2270 416 02XX	Mek+Tuş Işıklı Vavien (220V)	10	19,724
2270 417 02XX	Mek+Tuş Işıklı Çağırma (220V)	10	18,121
2270 418 02XX	Mek+Tuş Işıklı Etiketli Anahtar (220V)	10	16,498
2270 419 02XX	Mek+Tuş Işıklı Etiketli Çağırma (220V)	10	16,638
2270 422 02XX	Mek+Tuş Işıklı Zil Etiketli Çağırma (12V)	10	16,403
2270 426 02XX	Mek+Tuş Işıklı Komütatör	10	22,071

Anahtar Grubu Klipsli Tip (Kolay Bağlantı)

2270 401 01XX	Mek+Tuş Anahtar	10	12,437
2270 402 01XX	Mek+Tuş Komütatör	10	13,461
2270 403 01XX	Mek+Tuş Vavien (İki Yollu Anahtar)	10	14,460
2270 404 01XX	Mek+Tuş Komütatör Vavien	10	20,769
2270 405 01XX	Mek+Tuş Çift Kutuplu Anahtar	10	18,130
2270 406 01XX	Mek+Tuş Jaluzi Anahtar-Yaylı	10	21,705
2270 407 01XX	Mek+Tuş Light (Çağırma)	10	12,655
2270 407 01XXZ	Mek+Tuş Zil Anahtarı	10	12,655
2270 407 01XXX	Mek+Tuş Kapı Otomatiği Anahtarı	10	12,655
2270 408 01XX	Mek+Tuş Deviyatör (Ara Vavien)	10	15,965
2270 409 01XX	Mek+Tuş Uçlu Anahtar	10	18,057
2270 415 01XX	Mek+Tuş Işıklı Anahtar (220V)	10	16,463
2270 416 01XX	Mek+Tuş Işıklı Vavien (220V)	10	19,724
2270 417 01XX	Mek+Tuş Işıklı Çağırma (220V)	10	18,121
2270 418 01XX	Mek+Tuş Işıklı Etiketli Anahtar (220V)	10	16,498
2270 419 01XX	Mek+Tuş Işıklı Etiketli Çağırma (220V)	10	16,638
2270 422 01XX	Mek+Tuş Işıklı Zil Etiketli Çağırma (12V)	10	16,403
2270 426 01XX	Mek+Tuş Işıklı Komütatör	10	22,071

Dimmer Grubu

2270 440 02XX	Mek+Tuş Işıklı Dimmer 600W	8	60,427
2270 444 02XX	Mek+Tuş Işıklı Dimmer 1000W	8	75,812

Elektronik Grubu

2270 050 01XX	Mek+Tuş Energy Saver Gecikmesiz Işıklı	8	98,334
2270 052 01XX	Mek+Tuş Energy Saver Gecikmeli	8	90,563
2270 070 02XX	Mek+Tuş Müzik Yayın Anahtarı	8	70,798
2270 080 01XX	Mek+Tuş Hoparlör Prizi	10	27,619
2270 085 02XX	Mek+Tuş Uyarı Zili	10	61,760
2270 095 02XX	Mek+Tuş Hareket Sensörü	10	121,820

Priz Grubu

2270 600 02XX	Mek+Tuş Topraklı Priz	10	11,639
2270 601 02XX	Mek+Tuş Topraksız Priz	10	12,431
2270 605 02XX	Mek+Tuş Topraklı Priz (Çocuk Korumalı)	10	14,029
2270 606 02XX	Mek+Tuş Topraksız Priz (Çocuk Korumalı)	10	16,012
2270 610 02XX	Mek+Tuş Kapaklı Topraklı Priz	10	14,088
2270 611 02XX	Mek+Tuş Kapaklı Topraklı Priz (Çoc. Korml)	10	16,023
2270 615 02XX	Mek+Tuş Ups (Fransız) Prizi	10	15,734
2270 616 02XX	Mek+Tuş Ups (Fransız) Prizi(Çoc. Korumalı)	10	16,000
2270 617 02XX	Mek+Tuş Ups Kapaklı (Fransız) Priz	10	18,656
2270 618 02XX	Mek+Tuş Ups Kap. (Fransız) Priz (Çoc. Korml)	10	19,753
2270 121 02XX	Mek+Tuş Kör Kapak	10	11,853

İletişim Grubu

2270 455 01XX	Mek+Tuş Data Prizi 1*Usb	10	31,290
2270 456 01XX	Mek+Tuş Data Prizi 2*Usb	10	53,300
2270 457 01XX	Mek+Tuş Data Prizi 1*Hdmi	10	39,350
2270 458 01XX	Mek+Tuş Data Prizi 2*Hdmi	10	69,000
2270 459 01XX	Mek+Tuş Data Prizi 1*Usb/1*Hdmi	10	60,570
2270 125 01XX	Mek+Tuş Telefon Prizi 1*Rj12 Cat3	10	14,518
2270 126 01XX	Mek+Tuş Telefon Prizi 2*Rj12 Cat3	10	18,620
2270 128 01XX	Mek+Tuş Etiketli Tlf+Data Priz (Kon.süz)	10	9,620
2270 135 01XX	Mek+Tuş Data Prizi 1*Rj45 (Kon.süz)	10	8,996
2270 136 01XX	Mek+Tuş Data Prizi 1*Rj45 (Cat5e)	10	29,862
2270 137 01XX	Mek+Tuş Data Prizi 2*Rj45 (Kon.süz)	10	9,001
2270 138 01XX	Mek+Tuş Data Prizi 2*Rj45 (Cat5e)	10	43,755
2270 139 01XX	Mek+Tuş Tlf+Data Priz (Rj12 Cat3+Cat5e)	10	31,501
2270 140 01XX	Mek+Tuş Data Prizi 1*Rj45 (Cat6)	10	42,856
2270 141 01XX	Mek+Tuş Data Prizi 2*Rj45 (Cat6)	10	66,210

TV / Sat Grubu

2270 156 02XX	Mek+Tuş Tv-Sat Prizi (Geçişli) 4DB/F Kon.	10	51,551
2270 157 01XX	Mek+Tuş Tv-Sat Prizi (Sonlu)	10	67,943
2270 166 01XX	Mek+Tuş Sat Prizi (Geçişli) 4DB/F Konnektör	10	36,651
2270 167 01XX	Mek+Tuş Sat Prizi (Sonlu)	10	36,651
2270 170 01XX	Mek+Tuş Tv Prizi (Geçişli) 11DB	10	18,914
2270 171 01XX	Mek+Tuş Tv Prizi (Sonlu)	10	18,914
2270 172 01XX	Mek+Tuş Tv Prizi F Dişi	10	10,629





 Beyaz XX-01 Saten XX-90 Gümüş XX-92 Füme XX-95



Candela



ISO 9001:2008



Candela Natural

Beyaz / Krem Mekanizma + Tuş Ürün Listesi

Kod	Ürün Tanımı	Kutu Adedi	Koli Adedi	Fiyat
-----	-------------	------------	------------	-------

Anahtar Grubu Vidalı Tip

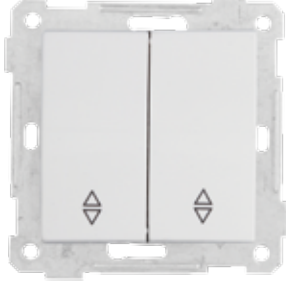

2100 401 02XX	Mek+Tuş Anahtar (Vidalı)	12	120	5,977
2100 402 02XX	Mek+Tuş Komütatör (Vidalı)	12	120	8,382
2100 403 02XX	Mek+Tuş Vavien (İki Yollu Anahtar)(Vidalı)	12	120	9,030
2100 404 02XX	Mek+Tuş Komütatör Vavien (Vidalı)	12	120	14,311
2100 405 02XX	Mek+Tuş Çift Kutuplu Anahtar (Vidalı)	12	120	9,541
2100 406 02XX	Mek+Tuş Jaluzi Anahtarı (Vidalı)	12	120	13,630
2100 407 02XX	Mek+Tuş Çağırma (Vidalı)	12	120	8,689
2100 407 02XXK	Mek+Tuş Kapı Otomatığı Anahtarı (Vidalı)	12	120	8,689
2100 407 02XXZ	Mek+Tuş Zil Anahtarı (Vidalı)	12	120	8,689
2100 408 02XX	Mek+Tuş Deviyatör(Ara Vavien)(Vidalı)	12	120	13,221
2100 409 02XX	Mek+Tuş Üçlü Anahtar (Vidalı)	12	120	12,778
2100 411 02XX	Mek+Tuş Şofben Anahtarı (Vidalı)	12	120	9,226
2100 415 02XX	Mek+Tuş Işıklı Anahtar (220V) (Vidalı)	12	120	12,800
2100 416 02XX	Mek+Tuş Işıklı Vavien (220V) (Vidalı)	12	120	15,111
2100 417 02XX	Mek+Tuş Işıklı Çağırma (220V)(Vidalı)	12	120	13,156
2100 418 02XX	Mek+Tuş Işıklı Etik. Anahtar (220V)(Vidalı)	12	120	13,889
2100 419 02XX	Mek+Tuş Işıklı Etik. Çağırma (220V)(Vidalı)	12	120	14,074
2100 422 02XX	Mek+Tuş Işıklı Zil Etik. Çağırma (12V)(Vidalı)	12	120	12,369
2100 426 02XX	Mek+Tuş Işıklı Komütatör (Vidalı)	12	120	16,711

Anahtar Grubu Klipsli Tip (Kolay Bağlantı)



2100 401 01XX	Mek+Tuş Anahtar (Klipsli)	12	120	5,977
2100 402 01XX	Mek+Tuş Komütatör (Klipsli)	12	120	8,382
2100 403 01XX	Mek+Tuş Vavien (İki Yollu Anahtar)(Klipsli)	12	120	9,030
2100 404 01XX	Mek+Tuş Komütatör Vavien (Klipsli)	12	120	14,311
2100 405 01XX	Mek+Tuş Çift Kutuplu Anahtar (Klipsli)	12	120	9,541
2100 406 01XX	Mek+Tuş Jaluzi Anahtarı (Klipsli)	12	120	13,630
2100 407 01XX	Mek+Tuş Çağırma (Klipsli)	12	120	8,689
2100 407 01XXK	Mek+Tuş Kapı Otomatığı Anahtarı(Klipsli)	12	120	8,689
2100 407 01XXZ	Mek+Tuş Zil Anahtarı(Klipsli)	12	120	8,689
2100 408 01XX	Mek+Tuş Deviyatör(Ara Vavien)(Klipsli)	12	120	13,221
2100 409 01XX	Mek+Tuş Üçlü Anahtar (Klipsli)	12	120	12,778
2100 415 01XX	Mek+Tuş Işıklı Anahtar (220V) (Klipsli)	12	120	12,800
2100 416 01XX	Mek+Tuş Işıklı Vavien (220V) (Klipsli)	12	120	15,111
2100 417 01XX	Mek+Tuş Işıklı Çağırma (220V)(Klipsli)	12	120	13,156
2100 418 01XX	Mek+Tuş Işıklı Etik. Anahtar (220V)(Klipsli)	12	120	13,889
2100 419 01XX	Mek+Tuş Işıklı Etik. Çağırma (220V)(Klipsli)	12	120	14,074
2100 422 01XX	Mek+Tuş Işıklı Zil Etik. Çağırma (12V)(Klipsli)	12	120	12,369
2100 426 01XX	Mek+Tuş Işıklı Komütatör (Klipsli)	12	120	16,711

Dimmer Grubu

2100 440 02XX	Mek+Tuş RL Işıklı Dimmer 600W	8	80	57,004
2100 444 02XX	Mek+Tuş RL Işıklı Dimmer 1000W	8	80	71,556

Elektronik Grubu

2100 450 01XX	Mek+Tuş Energy Saver G.siz Işıklı	8	80	81,778
2100 452 01XX	Mek+Tuş Energy Saver Gecikmeli Işıklı	8	80	81,773
2100 470 02XX	Mek+Tuş Müzik Yayın Anahtarı	8	80	65,778
2100 480 01XX	Mek+Tuş Hoparlör Prizi	8	80	11,500
2100 485 02XX	Mek+Tuş Uyarı Zili	8	80	51,556
2100 495 02XX	Mek+Tuş Hareket Sensörü	8	80	99,556

Priz Grubu

2100 600 02XX	Mek+Tuş Topraklı Priz	12	120	7,496
2100 601 02XX	Mek+Tuş Topraksız Priz	12	120	6,713
2100 605 02XX	Mek+Tuş Topraklı Priz (Çocuk Kor.)	12	120	8,881
2100 606 02XX	Mek+Tuş Topraksız Priz (Çocuk Kor.)	12	120	8,689
2100 610 02XX	Mek+Tuş Kapaklı Topraklı Priz	12	120	9,200
2100 611 02XX	Mek+Tuş Kapaklı Topraklı Priz (Çoc. Kor.)	12	120	11,585
2100 615 02XX	Mek+Tuş Ups (Fransız) Prizi	12	120	9,200
2100 616 02XX	Mek+Tuş Ups (Fransız) Prizi (Çoc. Kor.)	12	120	10,972
2100 617 02XX	Mek+Tuş Ups Kapaklı (Fransız) Priz	12	120	11,170
2100 618 02XX	Mek+Tuş Ups Kapaklı (Fr.) Priz (Çoc. Kor.)	12	120	11,415
2100 200 02XX	Mek+Tuş İkili Topraklı Priz Porselen	5	120	13,109
2100 201 02XX	Mek+Tuş İkili Topraksız Priz Porselen	5	50	10,873
2100 202 02XX	Mek+Tuş İkili Topraklı Priz	5	50	11,681
2100 203 02XX	Mek+Tuş İkili Topraksız Priz	5	50	9,329
2100 215 01XX	Mek+Tuş İkili Ups Priz	5	50	13,804
2100 448 01XX	Mek+Tuş Tekli Usb Şarj Prizi	5	50	67,706
2100 449 01XX	Mek+Tuş İkili Usb Şarj Prizi	5	50	69,284

Candela[®] Natural

Beyaz / Krem Mekanizma + Tuş Ürün Listesi

Kod	Ürün Tanımı	Kutu Adedi	Koli Adedi	Fiyat
-----	-------------	------------	------------	-------

İletişim Grubu

2100 125 01XX	Mek+Tuş Telefon Prizi 1Xrj12 (Cat3)	12	120	11,415
2100 126 01XX	Mek+Tuş Telefon Prizi 2Xrj12 (Cat3)	12	120	15,844
2100 128 01XX	Mek+Tuş Etiketli Tlf Data Priz (Kon.süz)	12	120	7,111
2100 135 02XX	Mek+Tuş Data Prizi 1*Rj45 (Kon.süz)	12	120	6,474
2100 136 01XX	Mek+Tuş Data Prizi 1*Rj45 (Cat5e)	12	120	18,741
2100 137 01XX	Mek+Tuş Data Prizi 2*Rj45 (Kon.süz)	12	120	7,150
2100 138 01XX	Mek+Tuş Data Prizi 2*Rj45 (Cat5e)	12	120	30,667
2100 139 01XX	Mek+Tuş Tlf Data Priz (Rj12 Cat3 + Cat5e)	12	120	24,874
2100 140 01XX	Mek+Tuş Data Prizi 1*Rj45 (Cat6)	12	120	20,632
2100 141 01XX	Mek+Tuş Data Prizi 2*Rj45 (Cat6)	12	120	37,190
2100 455 01XX	Mek+Tuş Data Prizi 1*Usb	12	120	28,278
2100 456 01XX	Mek+Tuş Data Prizi 2*Usb	12	120	49,313
2100 457 01XX	Mek+Tuş Data Prizi 1*Hdmi	12	120	35,431
2100 458 01XX	Mek+Tuş Data Prizi 2*Hdmi	12	120	63,258
2100 459 01XX	Mek+Tuş Data Prizi 1*Usb/1*Hdmi	12	120	55,339
2100 460 01XX	Mek+Tuş VGA Priz	12	120	55,200
2100 121 02XX	Mek+Tuş Kör Kapak	12	120	6,133

TV / Sat Grubu

2100 156 02XX	Mek+Tuş Tv-Sat Prizi (Geçişli) 4DB/F Kon.	12	120	47,805
2100 157 02XX	Mek+Tuş Tv-Sat Prizi (Sonlu)	12	120	47,805
2100 166 01XX	Mek+Tuş Sat Prizi (Geçişli) 4DB/F Kon.	12	120	23,852
2100 167 01XX	Mek+Tuş Sat Prizi (Sonlu)	12	120	23,852
2100 170 01XX	Mek+Tuş Tv Prizi (Geçişli) 11DB	12	120	15,048
2100 171 01XX	Mek+Tuş Tv Prizi (Sonlu)	12	120	15,048
2100 172 01XX	Mek+Tuş Tv Prizi F Dişi	12	120	9,030

Çerçeveler

2125 800 11XX	Tekli Çerçeve	20	400	1,244
2125 800 12XX	İkili Yatay Çerçeve	10	200	3,874
2125 800 13XX	Üçlü Yatay Çerçeve	10	50	4,978
2125 800 14XX	Dörtlü Yatay Çerçeve	10	50	6,139
2125 800 15XX	Beşli Yatay Çerçeve	10	50	7,799
2125 800 16XX	Altılı Yatay Çerçeve	10	50	10,287
2125 800 22XX	İkili Dikey Çerçeve	10	50	3,874
2125 800 23XX	Üçlü Dikey Çerçeve	10	50	4,978
2125 800 24XX	Dörtlü Dikey Çerçeve	10	50	6,139
2125 800 25XX	Beşli Dikey Çerçeve	10	50	7,799
2125 800 26XX	Altılı Dikey Çerçeve	10	50	10,287
2125 820 12XX	İkili Priz Çerçeve	12	60	2,367
2100 000 11XX	Sıva Üstü Kasa	12	60	3,502

İngiliz Tip

2190 500 0201	İngiliz Tipi Anahtarlı Priz Beyaz	12	120	28,00
---------------	-----------------------------------	----	-----	-------



Beyaz
01



Krem
02

Kod	Ürün Tanımı	Kutu Adedi	Koli Adedi	Fiyat
-----	-------------	------------	------------	-------

Anahtar Grubu Vidalı Tip

2100 401 02XX	Mek+Tuş Anahtar (Vidalı)	12	120	9,881
2100 402 02XX	Mek+Tuş Komütatör (Vidalı)	12	120	11,756
2100 403 02XX	Mek+Tuş Vavien (İki Yollu Anahtar)(Vidalı)	12	120	11,653
2100 404 02XX	Mek+Tuş Komütatör Vavien (Vidalı)	12	120	17,195
2100 405 02XX	Mek+Tuş Çift Kutuplu Anahtar (Vidalı)	12	120	11,756
2100 406 02XX	Mek+Tuş Jaluzi Anahtarı (Vidalı)	12	120	17,616
2100 407 02XX	Mek+Tuş Çağırma (Vidalı)	12	120	10,938
2100 407 02XXX	Mek+Tuş Kapı Otomatığı Anahtarı (Vidalı)	12	120	10,938
2100 407 02XXZ	Mek+Tuş Zil Anahtarı (Vidalı)	12	120	10,938
2100 408 02XX	Mek+Tuş Deviatör(Ara Vavien)(Vidalı)	12	120	16,873
2100 409 02XX	Mek+Tuş Üçlü Anahtar (Vidalı)	12	120	17,354
2100 411 02XX	Mek+Tuş Şofben Anahtarı (Vidalı)	12	120	11,993
2100 415 02XX	Mek+Tuş Işıklı Anahtar (220V) (Vidalı)	12	120	15,585
2100 416 02XX	Mek+Tuş Işıklı Vavien (220V) (Vidalı)	12	120	16,693
2100 417 02XX	Mek+Tuş Işıklı Çağırma (220V)(Vidalı)	12	120	17,066
2100 418 02XX	Mek+Tuş Işıklı Etik. Anahtar (220V)(Vidalı)	12	120	15,289
2100 419 02XX	Mek+Tuş Işıklı Etik. Çağırma (220V)(Vidalı)	12	120	15,289
2100 422 02XX	Mek+Tuş Işıklı Zil Etik. Çağırma (12V)(Vidalı)	12	120	14,652
2100 426 02XX	Mek+Tuş Işıklı Komütatör (Vidalı)	12	120	19,292

Anahtar Grubu Klipsli Tip (Kolay Bağlantı)

2100 401 01XX	Mek+Tuş Anahtar (Klipsli)	12	120	9,881
2100 402 01XX	Mek+Tuş Komütatör (Klipsli)	12	120	11,756
2100 403 01XX	Mek+Tuş Vavien (İki Yollu Anahtar)(Klipsli)	12	120	11,653
2100 404 01XX	Mek+Tuş Komütatör Vavien (Klipsli)	12	120	17,195
2100 405 01XX	Mek+Tuş Çift Kutuplu Anahtar (Klipsli)	12	120	11,756
2100 406 01XX	Mek+Tuş Jaluzi Anahtarı (Klipsli)	12	120	17,616
2100 407 01XX	Mek+Tuş Çağırma (Klipsli)	12	120	10,938
2100 407 01XXX	Mek+Tuş Kapı Otomatığı Anahtarı(Klipsli)	12	120	10,938
2100 407 01XXZ	Mek+Tuş Zil Anahtarı(Klipsli)	12	120	10,938
2100 408 01XX	Mek+Tuş Deviatör(Ara Vavien)(Klipsli)	12	120	16,873
2100 409 01XX	Mek+Tuş Üçlü Anahtar (Klipsli)	12	120	17,354
2100 415 01XX	Mek+Tuş Işıklı Anahtar (220V) (Klipsli)	12	120	15,585
2100 416 01XX	Mek+Tuş Işıklı Vavien (220V) (Klipsli)	12	120	16,693
2100 417 01XX	Mek+Tuş Işıklı Çağırma (220V)(Klipsli)	12	120	17,066
2100 418 01XX	Mek+Tuş Işıklı Etik. Anahtar (220V)(Klipsli)	12	120	15,289
2100 419 01XX	Mek+Tuş Işıklı Etik. Çağırma (220V)(Klipsli)	12	120	15,289
2100 422 01XX	Mek+Tuş Işıklı Zil Etik. Çağırma (12V)(Klipsli)	12	120	14,652
2100 426 01XX	Mek+Tuş Işıklı Komütatör (Klipsli)	12	120	19,292

Dimmer Grubu

2100 440 02XX	Mek+Tuş RL Işıklı Dimmer 600W	8	80	58,562
2100 444 02XX	Mek+Tuş RL Işıklı Dimmer 1000W	8	80	73,735

Elektronik Grubu

2100 450 01XX	Mek+Tuş Energy Saver G.siz Işıklı	8	80	84,433
2100 452 01XX	Mek+Tuş Energy Saver Gecikmeli Işıklı	8	80	84,436
2100 470 02XX	Mek+Tuş Müzik Yayın Anahtarı	8	80	71,778
2100 480 01XX	Mek+Tuş Hoparlör Prizi	8	80	31,559
2100 485 02XX	Mek+Tuş Uyarı Zili	8	80	56,124
2100 495 02XX	Mek+Tuş Hareket Sensörü	8	80	110,741

Priz Grubu

2100 600 02XX	Mek+Tuş Topraklı Priz	12	120	11,209
2100 601 02XX	Mek+Tuş Topraksız Priz	12	120	9,951
2100 605 02XX	Mek+Tuş Topraklı Priz (Çocuk Kor.)	12	120	15,169
2100 606 02XX	Mek+Tuş Topraksız Priz (Çocuk Kor.)	12	120	13,276
2100 610 02XX	Mek+Tuş Kapaklı Topraklı Priz	12	120	12,338
2100 611 02XX	Mek+Tuş Kapaklı Topraklı Priz (Çoc. Kor.)	12	120	17,505
2100 615 02XX	Mek+Tuş Ups (Fransız) Prizi	12	120	16,015
2100 616 02XX	Mek+Tuş Ups (Fransız) Prizi (Çoc. Kor.)	12	120	17,617
2100 617 02XX	Mek+Tuş Ups Kapaklı (Fransız) Priz	12	120	18,827
2100 618 02XX	Mek+Tuş Ups Kapaklı (Fr.) Priz (Çoc. Kor.)	12	120	20,969
2100 200 02XX	Mek+Tuş İkili Topraklı Priz Porselen	5	120	16,476
2100 201 02XX	Mek+Tuş İkili Topraksız Priz Porselen	5	50	15,333
2100 202 02XX	Mek+Tuş İkili Topraklı Priz	5	50	14,822
2100 203 02XX	Mek+Tuş İkili Topraksız Priz	5	50	11,926
2100 215 01XX	Mek+Tuş İkili Ups Priz	5	50	17,037
2100 448 01XX	Mek+Tuş Tekli Usb Şarj Prizi	5	50	74,750
2100 449 01XX	Mek+Tuş İkili Usb Şarj Prizi	5	50	76,878



Candela[®] Metalik

Mekanizma + Tuş Ürün Listesi

ANTİK ALTIN-80/İNÖX-82/TİTANYUM-83/FÜME-95/SEDEFLİ BEYAZ-81

Kod	Ürün Tanımı	Kutu Adedi	Koli Adedi	Fiyat
-----	-------------	------------	------------	-------

İletişim Grubu



2100 125 01XX	Mek+Tuş Telefon Prizi 1Xrj12 (Cat3)	12	120	13,630
2100 126 01XX	Mek+Tuş Telefon Prizi 2Xrj12 (Cat3)	12	120	20,104
2100 128 01XX	Mek+Tuş Etiketli Tlf Data Priz (Kon.süz)	12	120	9,466
2100 135 02XX	Mek+Tuş Data Prizi 1*Rj45 (Kon.süz)	12	120	9,021
2100 136 01XX	Mek+Tuş Data Prizi 1*Rj45 (Cat5e)	12	120	28,622
2100 137 01XX	Mek+Tuş Data Prizi 2*Rj45 (Kon.süz)	12	120	9,030
2100 138 01XX	Mek+Tuş Data Prizi 2*Rj45 (Cat5e)	12	120	44,978
2100 139 01XX	Mek+Tuş Tlf Data Priz (Rj12 Cat3 + Cat5e)	12	120	39,391
2100 140 01XX	Mek+Tuş Data Prizi 1*Rj45 (Cat6)	12	120	28,622
2100 141 01XX	Mek+Tuş Data Prizi 2*Rj45 (Cat6)	12	120	44,978
2100 455 01XX	Mek+Tuş Data Prizi 1*Usb	12	120	28,452
2100 456 01XX	Mek+Tuş Data Prizi 2*Usb	12	120	48,460
2100 457 01XX	Mek+Tuş Data Prizi 1*Hdmi	12	120	35,778
2100 458 01XX	Mek+Tuş Data Prizi 2*Hdmi	12	120	62,718
2100 459 01XX	Mek+Tuş Data Prizi 1*Usb/1*Hdmi	12	120	55,067
2100 460 01XX	Mek+Tuş VGA Priz	12	120	94,645
2100 121 02XX	Mek+Tuş Kör Kapak	12	120	13,942

TV / Sat Grubu

2100 156 02XX	Mek+Tuş Tv-Sat Prizi (Geçişli) 4DB/F Kon.	12	120	55,556
2100 157 02XX	Mek+Tuş Tv-Sat Prizi (Sonlu)	12	120	55,556
2100 166 01XX	Mek+Tuş Sat Prizi (Geçişli) 4DB/F Kon.	12	120	29,889
2100 167 01XX	Mek+Tuş Sat Prizi (Sonlu)	12	120	29,889
2100 170 01XX	Mek+Tuş Tv Prizi (Geçişli) 11DB	12	120	16,904
2100 171 01XX	Mek+Tuş Tv Prizi (Sonlu)	12	120	16,904
2100 172 01XX	Mek+Tuş Tv Prizi F Dişi	12	120	9,200

Çerçeveler

2125 800 11XX	Tekli Çerçeve	20	400	2,675
2125 800 12XX	İkili Yatay Çerçeve	10	200	4,941
2125 800 13XX	Üçlü Yatay Çerçeve	10	50	9,849
2125 800 14XX	Dörtlü Yatay Çerçeve	10	50	12,370
2125 800 15XX	Beşli Yatay Çerçeve	10	50	15,900
2125 800 16XX	Altılı Yatay Çerçeve	10	50	20,931
2125 800 22XX	İkili Dikey Çerçeve	10	50	4,941
2125 800 23XX	Üçlü Dikey Çerçeve	10	50	9,849
2125 800 24XX	Dörtlü Dikey Çerçeve	10	50	12,370
2125 800 25XX	Beşli Dikey Çerçeve	10	50	15,900
2125 800 26XX	Altılı Dikey Çerçeve	10	50	20,931
2125 820 12XX	İkili Priz Çerçeve	12	60	4,430
2100 000 11XX	Sıva Üstü Kasa	12	60	6,729



A. Altın
80



Inox
82



Titanyum
83

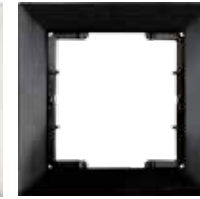

Siyah
84



Füme
95

Kod	Ürün Tanımı	Kutu Adedi	Koli Adedi	Fiyat
-----	-------------	------------	------------	-------

Anahtar Grubu Vidalı Tip

2100 401 02XX	Mek+Tuş Anahtar (Vidalı)	12	120	10,376
2100 402 02XX	Mek+Tuş Komütatör (Vidalı)	12	120	12,343
2100 403 02XX	Mek+Tuş Vavien (İki Yollu Anahtar)(Vidalı)	12	120	12,236
2100 404 02XX	Mek+Tuş Komütatör Vavien (Vidalı)	12	120	18,055
2100 405 02XX	Mek+Tuş Çift Kutuplu Anahtar (Vidalı)	12	120	12,343
2100 406 02XX	Mek+Tuş Jaluzi Anahtarı (Vidalı)	12	120	18,497
2100 407 02XX	Mek+Tuş Çağırma (Vidalı)	12	120	11,485
2100 407 02XXK	Mek+Tuş Kapı Otomatığı Anahtarı (Vidalı)	12	120	11,485
2100 407 02XXZ	Mek+Tuş Zil Anahtarı (Vidalı)	12	120	11,485
2100 408 02XX	Mek+Tuş Deviatör(Ara Vavien)(Vidalı)	12	120	17,717
2100 409 02XX	Mek+Tuş Üçlü Anahtar (Vidalı)	12	120	18,222
2100 411 02XX	Mek+Tuş Şofben Anahtarı (Vidalı)	12	120	12,593
2100 415 02XX	Mek+Tuş Işıklı Anahtar (220V) (Vidalı)	12	120	16,364
2100 416 02XX	Mek+Tuş Işıklı Vavien (220V) (Vidalı)	12	120	17,527
2100 417 02XX	Mek+Tuş Işıklı Çağırma (220V)(Vidalı)	12	120	17,919
2100 418 02XX	Mek+Tuş Işıklı Etik. Anahtar (220V)(Vidalı)	12	120	16,722
2100 419 02XX	Mek+Tuş Işıklı Etik. Çağırma (220V)(Vidalı)	12	120	16,722
2100 422 02XX	Mek+Tuş Işıklı Zil Etik. Çağırma (12V)(Vidalı)	12	120	15,384
2100 426 02XX	Mek+Tuş Işıklı Komütatör (Vidalı)	12	120	20,893

Anahtar Grubu Klipsli Tip (Kolya Bağlantı)

2100 401 01XX	Mek+Tuş Anahtar (Klipsli)	12	120	10,376
2100 402 01XX	Mek+Tuş Komütatör (Klipsli)	12	120	12,343
2100 403 01XX	Mek+Tuş Vavien (İki Yollu Anahtar)(Klipsli)	12	120	12,236
2100 404 01XX	Mek+Tuş Komütatör Vavien (Klipsli)	12	120	18,055
2100 405 01XX	Mek+Tuş Çift Kutuplu Anahtar (Klipsli)	12	120	12,343
2100 406 01XX	Mek+Tuş Jaluzi Anahtarı (Klipsli)	12	120	18,497
2100 407 01XX	Mek+Tuş Çağırma (Klipsli)	12	120	11,485
2100 407 01XXK	Mek+Tuş Kapı Otomatığı Anahtarı(Klipsli)	12	120	11,485
2100 407 01XXZ	Mek+Tuş Zil Anahtarı(Klipsli)	12	120	11,485
2100 408 01XX	Mek+Tuş Deviatör(Ara Vavien)(Klipsli)	12	120	17,717
2100 409 01XX	Mek+Tuş Üçlü Anahtar (Klipsli)	12	120	18,222
2100 415 01XX	Mek+Tuş Işıklı Anahtar (220V) (Klipsli)	12	120	16,364
2100 416 01XX	Mek+Tuş Işıklı Vavien (220V) (Klipsli)	12	120	17,527
2100 417 01XX	Mek+Tuş Işıklı Çağırma (220V)(Klipsli)	12	120	17,919
2100 418 01XX	Mek+Tuş Işıklı Etik. Anahtar (220V)(Klipsli)	12	120	16,722
2100 419 01XX	Mek+Tuş Işıklı Etik. Çağırma (220V)(Klipsli)	12	120	16,722
2100 422 01XX	Mek+Tuş Işıklı Zil Etik. Çağırma (12V)(Klipsli)	12	120	15,384
2100 426 01XX	Mek+Tuş Işıklı Komütatör (Klipsli)	12	120	20,893

Dimmer Grubu

2100 440 02XX	Mek+Tuş RL Işıklı Dimmer 600W	8	80	61,490
2100 444 02XX	Mek+Tuş RL Işıklı Dimmer 1000W	8	80	77,422

Elektronik Grubu

2100 450 01XX	Mek+Tuş Energy Saver G.siz Işıklı	8	80	88,655
2100 452 01XX	Mek+Tuş Energy Saver Gecikmeli Işıklı	8	80	90,666
2100 470 02XX	Mek+Tuş Müzik Yayın Anahtarı	8	80	75,367
2100 480 01XX	Mek+Tuş Hoparlör Prizi	8	80	33,136
2100 485 02XX	Mek+Tuş Uyarı Zili	8	80	58,931
2100 495 02XX	Mek+Tuş Hareket Sensörü	8	80	116,278

Priz Grubu

2100 600 02XX	Mek+Tuş Topraklı Priz	12	120	11,769
2100 601 02XX	Mek+Tuş Topraksız Priz	12	120	10,449
2100 605 02XX	Mek+Tuş Topraklı Priz (Çocuk Kor.)	12	120	17,719
2100 606 02XX	Mek+Tuş Topraksız Priz (Çocuk Kor.)	12	120	15,538
2100 610 02XX	Mek+Tuş Kapaklı Topraklı Priz	12	120	12,955
2100 611 02XX	Mek+Tuş Kapaklı Topraklı Priz (Çoc. Kor.)	12	120	18,666
2100 615 02XX	Mek+Tuş Ups (Fransız) Prizi	12	120	16,816
2100 616 02XX	Mek+Tuş Ups (Fransız) Prizi (Çoc. Kor.)	12	120	18,498
2100 617 02XX	Mek+Tuş Ups Kapaklı (Fransız) Priz	12	120	19,768
2100 618 02XX	Mek+Tuş Ups Kapaklı (Fr.) Priz (Çoc. Kor.)	12	120	22,017
2100 200 02XX	Mek+Tuş İkili Topraklı Priz Porselen	5	120	17,620
2100 201 02XX	Mek+Tuş İkili Topraksız Priz Porselen	5	50	16,377
2100 202 02XX	Mek+Tuş İkili Topraklı Priz	5	50	15,563
2100 203 02XX	Mek+Tuş İkili Topraksız Priz	5	50	12,522
2100 215 01XX	Mek+Tuş İkili Ups Priz	5	50	17,889
2100 448 01XX	Mek+Tuş Tekli Usb Şarj Prizi	5	50	84,755
2100 449 01XX	Mek+Tuş İkili Usb Şarj Prizi	5	50	87,170



Kod	Ürün Tanımı	Kutu Adedi	Koli Adedi	Fiyat
-----	-------------	------------	------------	-------

İletişim Grubu

2100 125 01XX	Mek+Tuş Telefon Prizi 1Xrj12 (Cat3)	12	120	14.857
2100 126 01XX	Mek+Tuş Telefon Prizi 2Xrj12 (Cat3)	12	120	21.109
2100 128 01XX	Mek+Tuş Etiketli Tlf Data Priz (Kon.süz)	12	120	11.762
2100 135 02XX	Mek+Tuş Data Prizi 1*Rj45 (Kon.süz)	12	120	11.756
2100 136 01XX	Mek+Tuş Data Prizi 1*Rj45 (Cat5e)	12	120	30.053
2100 137 01XX	Mek+Tuş Data Prizi 2*Rj45 (Kon.süz)	12	120	11.756
2100 138 01XX	Mek+Tuş Data Prizi 2*Rj45 (Cat5e)	12	120	47.227
2100 139 01XX	Mek+Tuş Tlf Data Priz (Rj12 Cat3 + Cat5e)	12	120	41.361
2100 140 01XX	Mek+Tuş Data Prizi 1*Rj45 (Cat6)	12	120	30.053
2100 141 01XX	Mek+Tuş Data Prizi 2*Rj45 (Cat6)	12	120	47.227
2100 455 01XX	Mek+Tuş Data Prizi 1*Usb	12	120	29.874
2100 456 01XX	Mek+Tuş Data Prizi 2*Usb	12	120	50.883
2100 457 01XX	Mek+Tuş Data Prizi 1*Hdmı	12	120	37.567
2100 458 01XX	Mek+Tuş Data Prizi 2*Hdmı	12	120	65.854
2100 459 01XX	Mek+Tuş Data Prizi 1*Usb/1*Hdmı	12	120	57.821
2100 460 01XX	Mek+Tuş VGA Priz	12	120	106.950
2100 121 02XX	Mek+Tuş Kör Kapak	12	120	14.639

TV / Sat Grubu

2100 156 02XX	Mek+Tuş Tv-Sat Prizi (Geçişli) 4DB/F Kon.	12	120	58.333
2100 157 02XX	Mek+Tuş Tv-Sat Prizi (Sonlu)	12	120	58.333
2100 166 01XX	Mek+Tuş Sat Prizi (Geçişli) 4DB/F Kon.	12	120	31.377
2100 167 01XX	Mek+Tuş Sat Prizi (Sonlu)	12	120	31.377
2100 170 01XX	Mek+Tuş Tv Prizi (Geçişli) 11DB	12	120	17.749
2100 171 01XX	Mek+Tuş Tv Prizi (Sonlu)	12	120	17.749
2100 172 01XX	Mek+Tuş Tv Prizi F Dişi	12	120	11.381

Çerçeveler

2125 800 11XX	Tekli Çerçeve	20	400	4.945
2125 800 12XX	İkili Yatay Çerçeve	10	200	8.924
2125 800 13XX	Üçlü Yatay Çerçeve	10	50	12.064
2125 800 14XX	Dörtlü Yatay Çerçeve	10	50	15.330
2125 800 15XX	Beşli Yatay Çerçeve	10	50	17.204
2125 800 16XX	Altılı Yatay Çerçeve	10	50	23.104
2125 800 22XX	İkili Dikey Çerçeve	10	50	8.924
2125 800 23XX	Üçlü Dikey Çerçeve	10	50	12.064
2125 800 24XX	Dörtlü Dikey Çerçeve	10	50	15.330
2125 800 25XX	Beşli Dikey Çerçeve	10	50	17.204
2125 800 26XX	Altılı Dikey Çerçeve	10	50	23.104
2125 820 12XX	İkili Priz Çerçeve	12	60	8.348
2100 000 11XX	Sıva Üstü Kasa	12	60	7.769



Kiraz
56



Ceviz
57

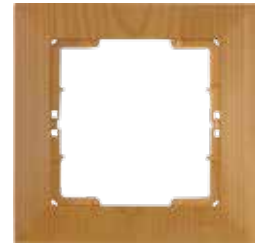

Meşe
58

CANDELA

DARIA

BRON

NEMLIYER

CANDELA
NEMLIYER
OLIMPIYER
RITA EL

Candela
Kids



PRIZLER BRON ELITRA PLUS

CANDELA

DARIA

BRON

NEMLIYER

OLIMPIYER



Candela Kids

BEYAZ

Kod	Ürün Tanımı	Kutu Adedi	Koli Adedi	Fiyat
2127 510 0101	Candela Kids -Traffic -Beyaz	12	120	23,081
2127 512 0101	Candela Kids -Train -Beyaz	12	120	23,081
2127 514 0101	Candela Kids -Caretta -Beyaz	12	120	23,081
2127 516 0101	Candela Kids -Balloon -Beyaz	12	120	23,081
2127 518 0101	Candela Kids -Dolphin -Beyaz	12	120	23,081
2127 520 0101	Candela Kids -Sea Horse -Beyaz	12	120	23,081
2127 522 0101	Candela Kids -Love -Beyaz	12	120	23,081
2127 524 0101	Candela Kids -Cow -Beyaz	12	120	23,081
2127 526 0101	Candela Kids -Carousel -Beyaz	12	120	23,081
2127 528 0101	Candela Kids -Diver -Beyaz	12	120	23,081



PEMBE

Kod	Ürün Tanımı	Kutu Adedi	Koli Adedi	Fiyat
2127 510 0111	Candela Kids -Traffic -Pembe	12	120	23,081
2127 512 0111	Candela Kids -Train - Pembe	12	120	23,081
2127 514 0111	Candela Kids -Caretta - Pembe	12	120	23,081
2127 516 0111	Candela Kids -Balloon - Pembe	12	120	23,081
2127 518 0111	Candela Kids -Dolphin - Pembe	12	120	23,081
2127 520 0111	Candela Kids -Sea Horse - Pembe	12	120	23,081
2127 522 0111	Candela Kids -Love - Pembe	12	120	23,081
2127 524 0111	Candela Kids -Cow - Pembe	12	120	23,081
2127 526 0111	Candela Kids -Carousel - Pembe	12	120	23,081
2127 528 0111	Candela Kids -Diver - Pembe	12	120	23,081



MAVİ

Kod	Ürün Tanımı	Kutu Adedi	Koli Adedi	Fiyat
2127 510 0112	Candela Kids -Traffic - Mavi	12	120	23,081
2127 512 0112	Candela Kids -Train - Mavi	12	120	23,081
2127 514 0112	Candela Kids -Caretta - Mavi	12	120	23,081
2127 516 0112	Candela Kids -Balloon - Mavi	12	120	23,081
2127 518 0112	Candela Kids -Dolphin - Mavi	12	120	23,081
2127 520 0112	Candela Kids -Sea Horse - Mavi	12	120	23,081
2127 522 0112	Candela Kids -Love - Mavi	12	120	23,081
2127 524 0112	Candela Kids -Cow - Mavi	12	120	23,081
2127 526 0112	Candela Kids -Carousel - Mavi	12	120	23,081
2127 528 0112	Candela Kids -Diver - Mavi	12	120	23,081



Gündüz



Carousel 2127-526-XX



Cow 2127-524-XX



Sea Horse 2127-520-XX

Gece

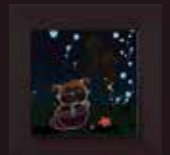

Gündüz



Traffic 2127-510-XX



Balloon 2127-516-XX



Love 2127-522-XX

Gece

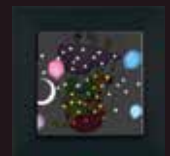
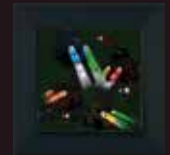

Gündüz



Train 2127-512-XX



Diver 2127-528-XX



Dolphin 2127-518-XX

Gece

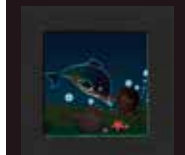
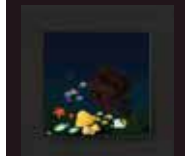



SPEAKPHONE



RCA



3,5 SES JAKI



XLR ERKEK



XLR DIŞI



USB PRINTER

► RİTA MODÜLER SİSTEM

Kod	Ürün Tanımı	Kutu Adedi	Fiyat
2200 250 01XX	Mek+Tuş Speakphone Prizi	1	MÜŞTERİ TEMSİLCİSİNE FİYAT SORUNUZ.
2200 251 01XX	Mek+Tuş RCA Prizi	1	
2200 252 01XX	Mek+Tuş 3,5 Ses Jaki	1	
2200 253 01XX	Mek+Tuş XLR Erkek Prizi	1	
2200 254 01XX	Mek+Tuş XLR Dişi Prizi	1	
2200 255 01XX	Mek+Tuş Usb Printer Prizi	1	



► ENERGY SAVER ÜRÜN LİSTESİ

Kod	Ürün Tanımı	Kutu Adedi	Fiyat
2100 852 0000	İki Röleli(30A+16A)Energy Saver Röle Ünitesi(VRF/FC) -Kutulu, Panoda 4 modül yer kaplar, 1 klima odalar içindir	1	MÜŞTERİ TEMSİLCİSİNE FİYAT SORUNUZ.
2100 853 0000	Üç Röleli(30A+2x16A)Energy Saver Röle Ünitesi(VRF/FC) -Kutulu, Panoda 6 modül yer kaplar, 2 klima odalar içindir	1	
2100 854 0000	İki Röleli(30A+16A)Energy Saver DND Röle Ünitesi(VRF/FC) (DND/MUR kontrolü için ünite olarak vavien komütatör kullanılması şarttır) -Kutulu, Panoda 6 modül yer kaplar, 1 klima odalar içindir	1	
2100 855 0000	Üç Röleli(30A+16A)Energy Saver DND Röle Ünitesi(VRF/FC) (DND/MUR kontrolü için ünite olarak vavien komütatör kullanılması şarttır) -Kutulu, Panoda 6 modül yer kaplar, 1 klima odalar içindir	1	
2110 052 0001	Energy Saver Kapak	1	
2100 012 01XX	Mek+Tuş Impuls Anahtar	12	
2100 023 01XX	Mek+Tuş Impuls Komütatör	12	
2100 024 01XX	Mek+Tuş Impuls Işıklı Anahtar (220V)	12	
2100 027 01XX	Mek+Tuş Impuls Işıklı Komütatör	12	
2125 010 0101	Otel Uyarı İç Ünitesi Komütatörü (Mekanik) Işıklı	12	
2220 010 0101	Rita Otel Uyarı İç Ünitesi Komütatörü (Mekanik) Işıklı	12	
2220 010 0201	Rita Otel Uyarı İç Ünitesi Komütatörü (Mekanik) Işıklı Vidalı	12	
2200 412 01XX	Rita Mek Tuş Impuls Anahtar (Klipsli)	12	
2200 412 02XX	Rita Mek Tuş Impuls Anahtar (Vidalı)	12	
2200 423 01XX	Rita Mek Tuş Impuls Komütatör (Klipsli)	12	
2200 423 02XX	Rita Mek Tuş Impuls Komütatör (Vidalı)	12	
2200 424 01XX	Rita Mek Tuş Impuls Işıklı Anahtar(Klipsli)	12	
2200 424 02XX	Rita Mek Tuş Impuls Işıklı Anahtar (Vidalı)	12	
2200 427 01XX	Rita Mek Tuş Impuls Işıklı Komütatör (Klipsli)	12	
2200 427 02XX	Rita Mek Tuş Impuls Işıklı Komütatör (Vidalı)	12	



Dariä



CANDELA
LITRA
DARIA
OLIMPIA

BRON ELITRA PLUS
FIS PRIZLER
LIVA
OLIMPIA
NEMLIYER

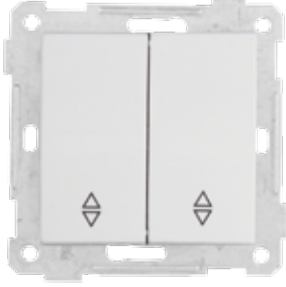

Kod	Ürün Tanımı	Kutu Adedi	Koli Adedi	Beyaz/Krem Fiyat	Metalik Fiyat	Ahşap Fiyat
2100 401 02XX	Mek+Tuş Anahtar	12	120	5,977	9,881	10,376
2100 402 02XX	Mek+Tuş Komütatör	12	120	8,382	11,756	12,343
2100 403 02XX	Mek+Tuş Vavien (İki Yollu Anahtar)	12	120	9,030	11,653	12,236
2100 404 02XX	Mek+Tuş Komütatör Vavien	12	120	14,311	17,195	18,055
2100 405 02XX	Mek+Tuş Çift Kutuplu Anahtar	12	120	9,541	11,756	12,343
2100 406 02XX	Mek+Tuş Jaluzi Anahtarı	12	120	13,630	17,616	18,497
2100 407 02XX	Mek+Tuş Çağırma	12	120	8,689	10,938	11,485
2100 407 02XXK	Mek+Tuş Kapı Otomatığı Anahtarı	12	120	8,689	10,938	11,485
2100 407 02XXZ	Mek+Tuş Zil Anahtarı	12	120	8,689	10,938	11,485
2100 408 02XX	Mek+Tuş Deviatör (Ara Vavien)	12	120	13,221	16,873	17,717
2100 409 02XX	Mek+Tuş Üçlü Anahtar	12	120	12,778	17,354	18,222
2100 411 02XX	Mek+Tuş Şofben Anahtarı	12	120	9,226	11,993	12,593
2100 415 02XX	Mek+Tuş Işıklı Anahtar (220V)	12	120	12,800	15,585	16,364
2100 416 02XX	Mek+Tuş Işıklı Vavien (220V)	12	120	15,111	16,693	17,527
2100 417 02XX	Mek+Tuş Işıklı Çağırma (220V)	12	120	13,156	17,066	17,919
2100 418 02XX	Mek+Tuş Işıklı Etik. Anahtar (220V)	12	120	13,889	15,289	16,722
2100 419 02XX	Mek+Tuş Işıklı Etik. Çağırma (220V)	12	120	14,074	15,289	16,722
2100 422 02XX	Mek+Tuş Işıklı Zil Etik. Çağırma (12V)	12	120	12,369	14,652	15,384
2100 426 02XX	Mek+Tuş Işıklı Komütatör	12	120	16,711	19,292	20,893

Anahtar Grubu Klipsli Tip (Kolay Bağlantı)



2100 401 01XX	Mek+Tuş Anahtar	12	120	5,977	9,881	10,376
2100 402 01XX	Mek+Tuş Komütatör	12	120	8,382	11,756	12,343
2100 403 01XX	Mek+Tuş Vavien (İki Yollu Anahtar)	12	120	9,030	11,653	12,236
2100 404 01XX	Mek+Tuş Komütatör Vavien	12	120	14,311	17,195	18,055
2100 405 01XX	Mek+Tuş Çift Kutuplu Anahtar	12	120	9,541	11,756	12,343
2100 406 01XX	Mek+Tuş Jaluzi Anahtarı	12	120	13,630	17,616	18,497
2100 407 01XX	Mek+Tuş Çağırma	12	120	8,689	10,938	11,485
2100 407 01XXK	Mek+Tuş Kapı Otomatığı Anahtarı	12	120	8,689	10,938	11,485
2100 407 01XXZ	Mek+Tuş Zil Anahtarı	12	120	8,689	10,938	11,485
2100 408 01XX	Mek+Tuş Deviatör (Ara Vavien)	12	120	13,221	16,873	17,717
2100 409 01XX	Mek+Tuş Üçlü Anahtar	12	120	12,778	17,354	18,222
2100 415 01XX	Mek+Tuş Işıklı Anahtar (220V)	12	120	12,800	15,585	16,364
2100 416 01XX	Mek+Tuş Işıklı Vavien (220V)	12	120	15,111	16,693	17,527
2100 417 01XX	Mek+Tuş Işıklı Çağırma (220V)	12	120	13,156	17,066	17,919
2100 418 01XX	Mek+Tuş Işıklı Etik. Anahtar (220V)	12	120	13,889	15,289	16,722
2100 419 01XX	Mek+Tuş Işıklı Etik. Çağırma (220V)	12	120	14,074	15,289	16,722
2100 422 01XX	Mek+Tuş Işıklı Zil Etik. Çağırma (12V)	12	120	12,369	14,652	15,384
2100 426 01XX	Mek+Tuş Işıklı Komütatör	12	120	16,711	19,292	20,893

Dimmer Grubu

2100 440 02XX	Mek+Tuş RL Işıklı Dimmer 600W	8	80	57,004	58,562	61,490
2100 444 02XX	Mek+Tuş RL Işıklı Dimmer 1000W	8	80	71,556	73,735	77,422

Elektronik Grubu

2100 450 01XX	Mek+Tuş Energy Saver G.sız Işıklı	8	80	81,778	84,433	88,655
2100 452 01XX	Mek+Tuş Energy Saver Gecikmeli Işıklı	8	80	81,773	84,436	90,666
2100 470 02XX	Mek+Tuş Müzik Yayın Anahtarı	8	80	65,778	71,778	75,367
2100 480 01XX	Mek+Tuş Hoparlör Prizi	8	80	11,500	31,559	33,136
2100 485 02XX	Mek+Tuş Uyarı Zili	8	80	51,556	56,124	58,931
2100 495 02XX	Mek+Tuş Hareket Sensörü	8	80	99,556	110,741	116,278

Priz Grubu



2100 600 02XX	Mek+Tuş Topraklı Priz	12	120	7,496	11,209	11,769
2100 601 02XX	Mek+Tuş Topraksız Priz	12	120	6,713	9,951	10,449
2100 605 02XX	Mek+Tuş Topraklı Priz (Çocuk Kor.)	12	120	9,881	15,169	17,719
2100 606 02XX	Mek+Tuş Topraksız Priz (Çocuk Kor.)	12	120	8,689	13,276	15,538
2100 610 02XX	Mek+Tuş Kapaklı Topraklı Priz	12	120	9,200	12,338	12,955
2100 611 02XX	Mek+Tuş Kapaklı Topraklı Priz (Çoc. Kor.)	12	120	11,585	17,505	18,666
2100 615 02XX	Mek+Tuş Ups (Fransız) Prizi	12	120	9,200	16,015	16,816
2100 616 02XX	Mek+Tuş Ups (Fransız) Prizi (Çoc. Kor.)	12	120	10,972	17,617	18,498
2100 617 02XX	Mek+Tuş Ups Kapaklı (Fransız) Priz	12	120	11,170	18,827	19,768
2100 618 02XX	Mek+Tuş Ups Kapaklı (Fr.) Priz (Çoc. Kor.)	12	120	11,415	20,969	22,017
2100 200 02XX	Mek+Tuş İkili Topraklı Priz Porselen	5	120	13,109	16,476	17,620
2100 201 02XX	Mek+Tuş İkili Topraksız Priz Porselen	5	50	10,873	15,333	16,377
2100 202 02XX	Mek+Tuş İkili Topraklı Priz	5	50	11,681	14,822	15,563
2100 203 02XX	Mek+Tuş İkili Topraksız Priz	5	50	9,329	11,926	12,522
2100 215 01XX	Mek+Tuş İkili Ups Priz	5	50	13,804	17,037	17,889
2100 448 01XX	Mek+Tuş Tekli Usb Şarj Prizi	5	50	67,706	74,750	84,755
2100 449 01XX	Mek+Tuş İkili Usb Şarj Prizi	5	50	69,284	76,878	87,170

Kod	Ürün Tanımı	Kutu Adedi	Koli Adedi	Beyaz/Krem Fiyat	Metalik Fiyat	Ahşap Fiyat
2100 125 01XX	Mek+Tuş Telefon Prizi 1Xrj12 (Cat3)	12	120	11,415	13,630	14,857
2100 126 01XX	Mek+Tuş Telefon Prizi 2Xrj12 (Cat3)	12	120	15,844	20,104	21,109
2100 128 01XX	Mek+Tuş Etiketli Tlf Data Priz (Kon.süz)	12	120	7,111	9,466	11,762
2100 135 02XX	Mek+Tuş Data Prizi 1*Rj45 (Kon.süz)	12	120	6,474	9,021	11,756
2100 136 01XX	Mek+Tuş Data Prizi 1*Rj45 (Cat5e)	12	120	18,741	28,622	30,053
2100 137 01XX	Mek+Tuş Data Prizi 2*Rj45 (Kon.süz)	12	120	7,150	9,030	11,756
2100 138 01XX	Mek+Tuş Data Prizi 2*Rj45 (Cat5e)	12	120	30,667	44,978	47,227
2100 139 01XX	Mek+Tuş Tlf Data Priz (Rj12 Cat3 + Cat5e)	12	120	24,874	39,391	41,361
2100 140 01XX	Mek+Tuş Data Prizi 1*Rj45 (Cat6)	12	120	20,632	28,622	30,053
2100 141 01XX	Mek+Tuş Data Prizi 2*Rj45 (Cat6)	12	120	37,190	44,978	47,227
2100 455 01XX	Mek+Tuş Data Prizi 1*Usb	12	120	28,278	28,452	29,874
2100 456 01XX	Mek+Tuş Data Prizi 2*Usb	12	120	49,313	48,460	50,883
2100 457 01XX	Mek+Tuş Data Prizi 1*Hdmi	12	120	35,431	35,778	37,567
2100 458 01XX	Mek+Tuş Data Prizi 2*Hdmi	12	120	63,258	62,718	65,854
2100 459 01XX	Mek+Tuş Data Prizi 1*Usb/1*Hdmi	12	120	55,339	55,067	57,821
2100 460 01XX	Mek+Tuş VGA Priz	12	120	55,200	94,645	106,950
2100 121 02XX	Mek+Tuş Kôr Kapak	12	120	6,133	13,942	14,639

İletişim Grubu

2100 156 02XX	Mek+Tuş Tv-Sat Prizi (Geçişli) 4DB/F Kon.	12	120	47,805	55,556	58,333
2100 157 02XX	Mek+Tuş Tv-Sat Prizi (Sonlu)	12	120	47,805	55,556	58,333
2100 166 01XX	Mek+Tuş Sat Prizi (Geçişli) 4DB/F Kon.	12	120	23,852	29,889	31,377
2100 167 01XX	Mek+Tuş Sat Prizi (Sonlu)	12	120	23,852	29,889	31,377
2100 170 01XX	Mek+Tuş Tv Prizi (Geçişli) 11DB	12	120	15,048	16,904	17,749
2100 171 01XX	Mek+Tuş Tv Prizi (Sonlu)	12	120	15,048	16,904	17,749
2100 172 01XX	Mek+Tuş Tv Prizi F Dişi	12	120	9,030	9,200	11,381

Çerçeveler

2125 800 11XX	Tekli Çerçeve	20	400	1,244	2,675	4,945
2125 800 12XX	İkili Yatay Çerçeve	10	200	3,874	4,941	8,924
2125 800 13XX	Üçlü Yatay Çerçeve	10	50	4,978	9,849	12,064
2125 800 14XX	Dörtlü Yatay Çerçeve	10	50	6,139	12,370	15,330
2125 800 15XX	Beşli Yatay Çerçeve	10	50	7,799	15,900	17,204
2125 800 16XX	Altılı Yatay Çerçeve	10	50	10,287	20,931	23,104
2125 800 22XX	İkili Dikey Çerçeve	10	50	3,874	4,941	8,924
2125 800 23XX	Üçlü Dikey Çerçeve	10	50	4,978	9,849	12,064
2125 800 24XX	Dörtlü Dikey Çerçeve	10	50	6,139	12,370	15,330
2125 800 25XX	Beşli Dikey Çerçeve	10	50	7,799	15,900	17,204
2125 800 26XX	Altılı Dikey Çerçeve	10	50	10,287	20,931	23,104
2125 820 12XX	İkili Priz Çerçeve	12	60	2,367	4,430	8,348
2100 000 11XX	Sıva Üstü Kasa	12	60	3,502	6,729	7,769



Beyaz 01 Krem 02



A. Altın 80 Inox 82 Titanyum 83 Siyah 84 Fırne 95



Kiraz 56 Ceviz 57 Meşe 58

BRON





01 Beyaz 02 Krem

BRON Natural

Sıva Üstü Anahtar Priz Serisi

Beyaz / Krem Ürün Listesi

Kod	Ürün Tanımı	Kutu Adedi	Koli Adedi	Fiyat
2160 301 02XX	Bron S/Ü Anahtar	10	100	7,451
2160 302 02XX	Bron S/Ü Komütatör	10	100	9,146
2160 303 02XX	Bron S/Ü Vavien	10	100	8,972
2160 307 02XX	Bron S/Ü Light (Çağırma)	10	100	7,838
2160 315 02XX	Bron S/Ü Işıklı Anahtar (220V)	10	100	12,611
2160 316 02XX	Bron S/Ü Işıklı Vavien (220V)	10	100	13,661
2160 317 02XX	Bron S/Ü Işıklı Light (Çağırma) (220V)	10	100	13,188
2160 326 02XX	Bron S/Ü Işıklı Komütatör	10	100	14,681
2160 100 02XX	Bron S/Ü Topraklı Priz	10	100	8,535
2160 101 02XX	Bron S/Ü Topraksız Priz	10	100	8,983
2160 103 02XX	Bron S/Ü Top.İ Priz Porselen	10	100	10,781
2160 104 02XX	Bron S/Ü Top.sız Priz Porselen	10	100	9,667
2160 110 02XX	Bron S/Ü Kapaklı Top.İ Priz	10	100	9,637
2160 113 02XX	Bron S/Ü Kapaklı Top.İ Priz Porselen	10	100	11,883
2160 115 02XX	Bron S/Ü Ups (Fransız) Priz	10	100	8,920
2160 125 02XX	Bron S/Ü Telefon Prizi 1*Rj12 Cat3	10	100	10,278
2160 136 02XX	Bron S/Ü Data Prizi 1*Rj45 (Cat5)	10	100	14,076
2160 166 02XX	Bron S/Ü Sat Prizi (Geçişli) 4Db/F Konnektör	10	100	24,620
2160 167 02XX	Bron S/Ü Sat Prizi (Sonlu)	10	100	24,620
2160 170 02XX	Bron S/Ü Tv Prizi (Geçişli)	10	100	15,733
2160 171 02XX	Bron S/Ü Tv Prizi (Sonlu)	10	100	15,733
2160 200 02XX	Bron S/Ü İkili Top.İ Priz Porselen	5	50	16,295
2160 201 02XX	Bron İkili Topraksız Priz Porselen	5	50	13,831
2160 202 02XX	Bron S/Ü İkili Topraklı Priz	5	50	12,814
2160 203 02XX	Bron S/Ü İkili Topraksız Priz	5	50	10,749
2160 215 02XX	Bron S/Ü İkili Ups (Fransız) Priz	5	50	13,229

Sıva Üstü Anahtar Priz Serisi

Meşe / Ceviz Ürün Listesi

BRON Ahşap



58 Meşe 57 Ceviz

Kod	Ürün Tanımı	Kutu Adedi	Koli Adedi	Fiyat
2160 301 02XX	Bron S/Ü Anahtar	10	100	13,251
2160 302 02XX	Bron S/Ü Komütatör	10	100	15,460
2160 303 02XX	Bron S/Ü Vavien	10	100	14,671
2160 307 02XX	Bron S/Ü Light (Çağırma)	10	100	13,567
2160 315 02XX	Bron S/Ü Işıklı Anahtar (220V)	10	100	17,353
2160 316 02XX	Bron S/Ü Işıklı Vavien (220V)	10	100	18,299
2160 317 02XX	Bron S/Ü Işıklı Light (Çağırma) (220V)	10	100	17,668
2160 326 02XX	Bron S/Ü Işıklı Komütatör	10	100	19,877
2160 100 02XX	Bron S/Ü Topraklı Priz	10	100	15,775
2160 101 02XX	Bron S/Ü Topraksız Priz	10	100	12,620
2160 103 02XX	Bron S/Ü Top.İ Priz Porselen	10	100	14,754
2160 104 02XX	Bron S/Ü Top.sız Priz Porselen	10	100	13,377
2160 110 02XX	Bron S/Ü Kapaklı Top.İ Priz	10	100	16,406
2160 113 02XX	Bron S/Ü Kapaklı Top.İ Priz Porselen	10	100	18,634
2160 115 02XX	Bron S/Ü Ups (Fransız) Priz	10	100	13,228
2160 125 02XX	Bron S/Ü Telefon Prizi 1*Rj12	10	100	16,722
2160 136 02XX	Bron S/Ü Data Prizi 1*Rj45 (Cat5)	10	100	28,395
2160 166 02XX	Bron S/Ü Sat Prizi (Geçişli) 4Db/F Konnektör	10	100	22,874
2160 167 02XX	Bron S/Ü Sat Prizi (Sonlu)	10	100	22,874
2160 170 02XX	Bron S/Ü Tv Prizi (Geçişli)	10	100	19,561
2160 171 02XX	Bron S/Ü Tv Prizi (Sonlu)	10	100	19,561
2160 200 02XX	Bron S/Ü İkili Top.İ Priz Porselen	5	50	23,663
2160 201 02XX	Bron İkili Topraksız Priz Porselen	5	50	18,930
2160 202 02XX	Bron S/Ü İkili Topraklı Priz	5	50	21,770
2160 203 02XX	Bron S/Ü İkili Topraksız Priz	5	50	17,353
2160 215 02XX	Bron S/Ü İkili Ups (Fransız) Priz	5	50	23,978

CANDELA

DARIA

RITA

NEMLIYER

BRON

NEMLIYER

OLIMPIYER

RITA ELIYER

PRIZLER

BRON

ELITRA PLUS

CANDELA

DARIA

BRON

NEMLIYER

Nemliyer



ISO 9001:2008



Nemliyer Natural

Beyaz / Gri Ürün Listesi

Kod	Ürün Tanımı	Kutu Adedi	Koli Adedi	Fiyat
2150 001 01XX	Anahtar Nemliyer	10	100	10,601
2150 002 01XX	Komütatör Nemliyer	10	100	12,472
2150 003 01XX	Vavien (iki Yollu Anahtar) Nemliyer	10	100	12,812
2150 005 01XX	Çift Kutup. Anahtar Nemliyer	10	100	12,124
2150 007 01XX	Çağırma Nemliyer	10	100	11,024
2150 008 01XX	Deviatör (Ara Vavien) Nemliyer	10	100	16,066
2150 110 02XX	Kap.lı Top.lı Priz Nemliyer	8	80	11,656
2150 115 02XX	Ups Kapaklı Top.lı Priz Nemliyer	8	80	13,193
2150 125 02XX	Telefon Prizi 1 *Rj12 Nemliyer	10	100	12,089
2150 136 01XX	Data Prizi 1 *Rj45 (Cat5e) Nemliyer	10	100	15,663
2150 166 02XX	Sat Prizi (Geçişli) Nemliyer	10	100	23,327
2150 167 02XX	Sat Prizi (Sonlu) Nemliyer	10	100	23,327
2150 170 02XX	Tv Prizi (Geçişli) Nemliyer	10	100	18,015
2150 171 02XX	Tv Prizi (Sonlu) Nemliyer	10	100	18,015



Beyaz-01



Gri-03



Nemliyer Ahşap

Ahşap Ürün Listesi

Kod	Ürün Tanımı	Kutu Adedi	Koli Adedi	Fiyat
2150 001 01XX	Anahtar Nemliyer Ahşap	10	100	13,383
2150 002 01XX	Komütatör Nemliyer Ahşap	10	100	15,872
2150 003 01XX	Vavien (iki Yollu Anahtar) Nemliyer Ahşap	10	100	15,576
2150 005 01XX	Çift Kutup. Anahtar Nemliyer Ahşap	10	100	14,884
2150 007 01XX	Çağırma Nemliyer Ahşap	10	100	13,800
2150 008 01XX	Deviatör (Ara Vavien) Nemliyer Ahşap	10	100	18,771
2150 110 02XX	Kap.lı Top.lı Priz Nemliyer Ahşap	8	80	14,206
2150 115 02XX	Ups Kapaklı Top.lı Priz Nemliyer Ahşap	8	80	15,947
2150 125 02XX	Telefon Prizi 1 *Rj12 Cat3 Nemliyer Ahşap	10	100	8,762
2150 136 01XX	Data Prizi 1 *Rj45 (Cat5e) Nemliyer Ahşap	10	100	17,300
2150 166 02XX	Sat Prizi (Geçişli) Nemliyer Ahşap	10	100	24,912
2150 167 02XX	Sat Prizi (Sonlu) Nemliyer Ahşap	10	100	24,912
2150 170 02XX	Tv Prizi (Geçişli) Nemliyer Ahşap	10	100	19,685
2150 171 02XX	Tv Prizi (Sonlu) Nemliyer Ahşap	10	100	16,685



MUT-40
AÇIK KAYIN



MUT-41
KOYU CEVİZ



MUT-43
MERBAU



MUT-44
MAUN



MUT-49
ARMUT

CANDELA

DARIA

RITA

NEMLIYER

Fiş Prizler Grup Prizler



PRIZLER

BRON

ELITRA PLUS

CANDELA

RITA

BRON

NEMLIYER

OLIM

Kod	Ürün Tanımı	Kutu Adedi	Fiyat
001 171 290001 00 00	İkili Topraksız Grup Priz (Klemensli) Olimpia	25	6,456
001 171 290002 02 00	İkili Topraksız Grup Priz (2Mt) Olimpia	12	12,744
001 171 290002 03 00	İkili Topraksız Grup Priz (3Mt) Olimpia	12	14,783
001 171 290002 05 00	İkili Topraksız Grup Priz (5Mt) Olimpia	12	18,885
001 171 390001 00 00	Üçlü Topraksız Grup Priz (Klemensli) Olimpia	25	8,212
001 171 390002 02 00	Üçlü Topraksız Grup Priz (2Mt) Olimpia	12	14,378
001 171 390002 03 00	Üçlü Topraksız Grup Priz(3Mt) Olimpia	12	16,329
001 171 390002 05 00	Üçlü Topraksız Grup Priz (5Mt) Olimpia	12	20,674
001 171 210001 00 00	İkili Topraklı Grup Priz (Klemensli) Olimpia	25	8,081
001 171 210002 02 00	İkili Topraklı Grup Priz (2Mt) Olimpia	12	17,466
001 171 210002 03 00	İkili Topraklı Grup Priz (3M) Olimpia	12	20,812
001 171 210002 05 00	İkili Topraklı Grup Priz (5M) Olimpia	12	27,484
001 171 310001 00 00	Üçlü Grup Priz Topraklı (Klemensli) Olimpia	25	9,249
001 171 310002 02 00	Üçlü Topraklı Grup Priz (2Mt) Olimpia	12	18,615
001 171 310002 03 00	Üçlü Topraklı Grup Priz (3Mt) Olimpia	12	21,830
001 171 310002 05 00	Üçlü Topraklı Grup Priz (5Mt) Olimpia	12	28,711
001 171 320001 00 00	Üçlü Topraklı Grup Priz (Klemensli Anahtarlı) Olimpia	25	15,187
001 171 320002 02 00	Üçlü Topraklı Grup Priz (Anahtarlı 2 Mt) Olimpia	12	24,204
001 171 320002 03 00	Üçlü Topraklı Grup Priz (Anahtarlı 3 Mt) Olimpia	12	27,549
001 171 320002 05 00	Üçlü Topraklı Grup Priz (Anahtarlı 5 Mt) Olimpia	12	34,370
001 171 340001 00 00	Üçlü Ups Grup Priz (Klemensli) Olimpia	25	10,994
001 171 330001 02 00	Üçlü Ups Grup Priz (2Mt) Olimpia	12	21,325
001 171 330001 03 00	Üçlü Ups Grup Priz (3Mt) Olimpia	12	24,972
001 171 330001 05 00	Üçlü Ups Grup Priz (5Mt) Olimpia	12	31,804
001 171 410001 00 00	Dörtlü Topraklı Grup Priz (Klemensli) Olimpia	25	12,187
001 171 410001 02 00	Dörtlü Topraklı Grup Priz (2Mt) Olimpia	12	20,694
001 171 410001 03 00	Dörtlü Topraklı Grup Priz (3Mt) Olimpia	12	24,039
001 171 410001 05 00	Dörtlü Topraklı Grup Priz (5Mt) Olimpia	12	30,860
001 171 410002 00 00	Dörtlü Topraklı Grup Priz (Klemensli-Anah. Olimpia)	25	17,577
001 171 410002 02 00	Dörtlü Topraklı Grup Priz (Anahtarlı 2 Mt) Olimpia	12	26,414
001 171 410002 03 00	Dörtlü Topraklı Grup Priz (Anahtarlı 3 Mt) Olimpia	12	30,114
001 171 410002 05 00	Dörtlü Topraklı Grup Priz (Anahtarlı 5 Mt) Olimpia	12	36,580
001 171 610001 00 00	Altılı Grup Priz Top.lı (Klemensli) Olimpia	25	16,722
001 171 610001 02 00	Altılı Topraklı Grup Priz (2 Mt) Olimpia	12	28,213
001 171 610001 03 00	Altılı Topraklı Grup Priz (3 Mt) Olimpia	12	32,659
001 171 610001 05 00	Altılı Topraklı Grup Priz (5 Mt) Olimpia	12	42,443
001 171 610002 00 00	Altılı Topraklı Grup Priz (Klemensli-Anahtarlı) Olimpia	25	21,425
001 171 610002 02 00	Altılı Topraklı Grup Priz (Anahtarlı 2 Mt) Olimpia	12	33,155
001 171 610002 03 00	Altılı Topraklı Grup Priz (Anahtarlı 3 Mt) Olimpia	12	37,760
001 171 610002 05 00	Altılı Topraklı Grup Priz (Anahtarlı 5 Mt) Olimpia	12	47,023
001 171 614001 02 00	Altılı Top. G.Priz (2 Mt) (3X1,5mm ²) Olimpia	12	28,354
001 171 614001 03 00	Altılı Top. G.Priz (3 Mt) (3X1,5mm ²) Olimpia	12	32,798
001 171 614001 05 00	Altılı Top. G.Priz (5 Mt) (3X1,5mm ²) Olimpia	12	42,447
001 171 614002 02 00	Altılı Top. G.Priz (Anah. 2 Mt) (3X1,5mm ²) Olimpia	12	33,166
001 171 614002 03 00	Altılı Top. G.Priz (Anah. 3 Mt) (3X1,5mm ²) Olimpia	12	37,897
001 171 614002 05 00	Altılı Top. G.Priz (Anah. 5 Mt) (3X1,5mm ²) Olimpia	12	47,027
001 170 110001 00 00	10 lu Topraklı Grup Priz (Klemensli)	20	33,979

Fiş Prizler

Ürün Listesi



Ürün Kodu	001 170 011001 00 00
Ürün Adı	Topraklı Erkek Fiş
Kutu Adedi	50
Fiyatı	3,400



Ürün Kodu	001 170 012001 00 00
Ürün Adı	Topraklı Erkek Fiş (Kuyruklu)
Kutu Adedi	50
Fiyatı	3,562



Ürün Kodu	001 170 010001 00 00
Ürün Adı	Erkek Fiş
Kutu Adedi	50
Fiyatı	2,407



Ürün Kodu	001 170 011003 00 00
Ürün Adı	Topraklı Erkek Fiş Ups (Kuyruklu)
Kutu Adedi	50
Fiyatı	4,562



Ürün Kodu	001 170 020001 00 00
Ürün Adı	Dişi Fiş
Kutu Adedi	50
Fiyatı	1,931



Ürün Kodu	001 170 011002 00 00
Ürün Adı	Kulplu Topraklı Erkek Fiş
Kutu Adedi	50
Fiyatı	3,491



Ürün Kodu	001 170 033001 00 00
Ürün Adı	Topraklı Üçlü Fiş-Priz (Yonca Tip) (S/A)
Kutu Adedi	12
Fiyatı	12,186



Ürün Kodu	001 170 021001 00 00
Ürün Adı	Topraklı Dişi Fiş
Kutu Adedi	25
Fiyatı	3,917



Ürün Kodu	001 170 033003 00 00
Ürün Adı	İkili Topraklı Fiş-Priz (Düz Tip)
Kutu Adedi	24
Fiyatı	13,708



Ürün Kodu	001 170 033002 00 00
Ürün Adı	Topraklı Üçlü Fiş-Priz (Yonca Tip) (S/U)
Kutu Adedi	20
Fiyatı	11,870



Ürün Kodu	001 170 030002 00 00
Ürün Adı	Adaptör Fiş, Priz (İngiliz Tip)
Kutu Adedi	50
Fiyatı	1,183 USD



Ürün Kodu	001 170 033005 00 00
Ürün Adı	Üçlü Topraklı Fiş-Priz (Düz Tip)
Kutu Adedi	24
Fiyatı	16,554



Ürün Kodu	001 170 030001 00 00
Ürün Adı	Arapuar Anahtar
Kutu Adedi	50
Fiyatı	3,182



Ürün Kodu	001 170 033004 00 00
Ürün Adı	Üçlü Topraklı Fiş-Priz (Düz Tip Anahtarlı)
Kutu Adedi	24
Fiyatı	22,848

KABLO KANALLARI DELİKLİ KANALLAR



floret®

HF
HALOGEN
FREE







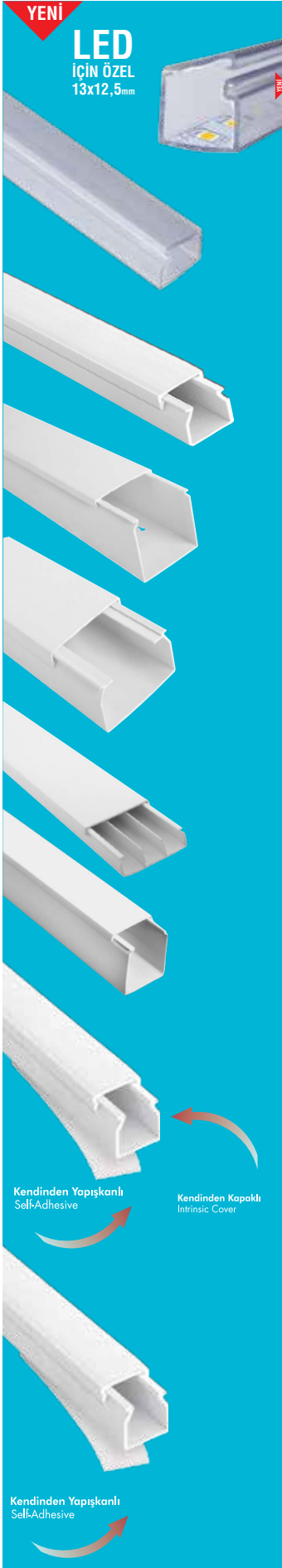

































Flame Retardant
Alev Yaymayan

Kaliteli
Yaşamın
Alt Yapısı









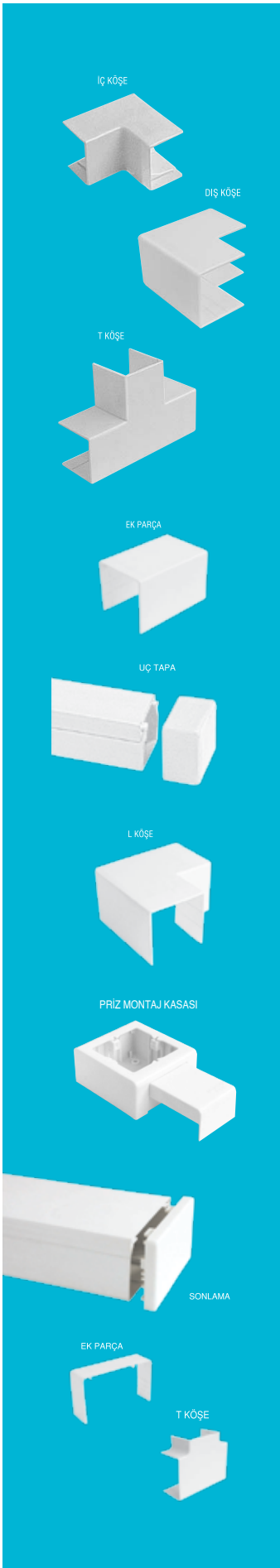



Kod	Açıklama / Stok Cinsi	Amb. (Kutu)	Amb. Birimi	FİYAT
LED İÇİN KENDİNDEN KAPAKLI KABLO KANALI IP40				
001 004 013012 20 44	13X12,5 MM KABLO KANALI ŞEFFAF KANAL (LED İÇİN)	300	mt.	2.878
CANALEX SERİSİ TSE'Lİ KAPALI TİP KABLO KANALLARI (KUTULU) IP40				
001 156 012012 20 00	12X12 MM KABLO KANALI (CANALEX)	250	mt.	0,831
001 156 015010 20 00	15X10 MM KABLO KANALI (CANALEX)	250	mt.	0,871
001 156 016016 20 00	16X16 MM KABLO KANALI (CANALEX)	250	mt.	1,126
001 156 020015 20 00	20X15 MM KABLO KANALI (CANALEX)	144	mt.	1,616
001 156 025016 20 00	25X16 MM KABLO KANALI (CANALEX)	150	mt.	1,643
001 156 025025 20 00	25X25 MM KABLO KANALI (CANALEX)	100	mt.	2,120
001 156 040016 20 00	40X16 MM KABLO KANALI (CANALEX)	100	mt.	2,450
001 156 040025 20 00	40X25 MM KABLO KANALI (CANALEX)	80	mt.	3,002
001 156 040040 20 00	40X40 MM KABLO KANALI (CANALEX)	50	mt.	3,489
001 156 060040 20 00	60X40 MM KABLO KANALI (CANALEX)	40	mt.	5,658
001 156 060060 20 00	60X60 MM KABLO KANALI (CANALEX)	32	mt.	8,577
001 156 080040 20 00	80X40 MM KABLO KANALI (CANALEX)	30	mt.	8,257
001 156 080060 20 00	80X60 MM KABLO KANALI (CANALEX)	24	mt.	9,521
001 156 100040 20 00	100X40 MM KABLO KANALI (CANALEX)	24	mt.	10,006
001 156 100060 20 00	100X60 MM KABLO KANALI (CANALEX)	20	mt.	12,911
CANALEX SERİSİ TSE'Lİ KAPALI TİP KABLO KANALLARI (YAPIŞKAN BANTLI)				
001 157 012012 20 00	12X12 MM KABLO KANALI CANALEX (YAPIŞKAN BANTLI)	250	mt.	0,978
001 157 015010 20 00	15X10 MM KABLO KANALI CANALEX (YAPIŞKAN BANTLI)	230	mt.	1,130
001 157 016016 20 00	16X16 MM KABLO KANALI CANALEX (YAPIŞKAN BANTLI)	230	mt.	1,352
001 157 020015 20 00	20X15 MM KABLO KANALI CANALEX (YAPIŞKAN BANTLI)	144	mt.	2,119
001 157 025016 20 00	25X16 MM KABLO KANALI CANALEX (YAPIŞKAN BANTLI)	150	mt.	2,035
001 157 025025 20 00	25X25 MM KABLO KANALI CANALEX (YAPIŞKAN BANTLI)	100	mt.	2,743
001 157 040016 20 00	40X16 MM KABLO KANALI CANALEX (YAPIŞKAN BANTLI)	100	mt.	3,285
001 157 040025 20 00	40X25 MM KABLO KANALI CANALEX (YAPIŞKAN BANTLI)	80	mt.	4,153
001 157 040040 20 00	40X40 MM KABLO KANALI CANALEX (YAPIŞKAN BANTLI)	50	mt.	4,861
001 157 060040 20 00	60X40 MM KABLO KANALI CANALEX (YAPIŞKAN BANTLI)	40	mt.	6,634
EKO SERİSİ TSE'Lİ KAPALI TİP KABLO KANALLARI				
001 014 010008 20 00	10X08 MM KABLO KANALI EKO	330	mt.	0,930
001 014 012012 20 00	12X12 MM KABLO KANALI EKO	250	mt.	0,960
001 014 015010 20 00	15X10 MM KABLO KANALI EKO	250	mt.	0,979
001 014 015015 20 00	15X15 MM KABLO KANALI EKO	250	mt.	1,443
001 014 016016 20 00	16X16 MM KABLO KANALI EKO	250	mt.	1,492
001 014 020010 20 00	20X10 MM KABLO KANALI EKO	200	mt.	1,206
001 014 025016 20 00	25X16 MM KABLO KANALI EKO	150	mt.	1,877
001 014 025025 20 00	25X25 MM KABLO KANALI EKO	100	mt.	2,452
001 014 025040 20 00	25X40 MM KABLO KANALI EKO	80	mt.	5,831
001 014 930010 20 00	30X10 MM KABLO KANALI EKO (BÖLMELİ)	140	mt.	2,439
001 014 030015 20 00	30X15 MM KABLO KANALI EKO	140	mt.	2,412
001 014 930016 20 00	30X16 MM KABLO KANALI EKO (BÖLMELİ)	140	mt.	3,209
001 014 030016 20 00	30X16 MM KABLO KANALI EKO	140	mt.	2,585
001 014 030025 20 00	30X25 MM KABLO KANALI EKO	80	mt.	3,330
001 014 030030 20 00	30X30 MM KABLO KANALI EKO	80	mt.	3,158
001 014 940016 20 00	40X16 MM KABLO KANALI EKO (BÖLMELİ)	100	mt.	3,636
001 014 040016 20 00	40X16 MM KABLO KANALI EKO	100	mt.	2,796
001 014 040025 20 00	40X25 MM KABLO KANALI EKO	80	mt.	3,695
001 014 040040 20 00	40X40 MM KABLO KANALI EKO	50	mt.	4,361
001 014 040060 20 00	40X60 MM KABLO KANALI EKO	40	mt.	9,301
001 014 960025 20 00	60X25 MM KABLO KANALI EKO (BÖLMELİ)	40	mt.	6,395
001 014 060040 20 00	60X40 MM KABLO KANALI EKO	40	mt.	6,612
001 014 050050 20 00	50X50 MM KABLO KANALI EKO	30	mt.	8,047
001 014 060060 20 00	60X60 MM KABLO KANALI EKO	32	mt.	8,947
001 014 075075 20 00	75X75 MM KABLO KANALI EKO	28	mt.	13,288
001 014 080040 20 00	80X40 MM KABLO KANALI EKO	30	mt.	10,120
001 014 080060 20 00	80X60 MM KABLO KANALI EKO	24	mt.	11,091
001 014 100040 20 00	100X40 MM KABLO KANALI EKO (PRİZ SETİ TAKILABİLİR)	24	mt.	11,388
001 014 100037 20 00	100X37 MM KABLO KANALI İÇTEN KAPAKLI KANAL EKO FOLYOLU (PRİZ SETİ TAKILABİLİR)	30	mt.	12,773
001 014 100050 20 00	100X50 MM KABLO KANALI İÇTEN KAPAKLI KANAL EKO FOLYOLU (PRİZ SETİ TAKILABİLİR)	20	mt.	13,157
001 014 100060 20 00	100X60 MM KABLO KANALI EKO (PRİZ SETİ TAKILABİLİR)	20	mt.	13,774
001 014 120060 20 00	120X60 MM KABLO KANALI EKO	16	mt.	20,893
001 014 100100 20 00	100X100 MM KABLO KANALI EKO	20	mt.	26,291
EKO SERİSİ KAPALI TİP KABLO KANALLARI (YAPIŞKAN BANTLI)				
001 004 009005 20 00	9X5 MM KABLO KANALI KEN.KAPAKLI	500	mt.	1,332
001 004 010007 20 44	9,5X7 MM KABLO KANALI ŞEFFAF KANAL	500	mt.	1,729
001 004 012007 20 00	12X7,5 MM KABLO KANALI KENDİNDEN KAPAKLI	350	mt.	1,428
001 004 013012 20 00	13X12,5 MM KABLO KANALI KENDİNDEN KAPAKLI	300	mt.	1,907
001 004 010008 20 00	10X8 MM KABLO KANALI EKO (YAPIŞKAN BANTLI)	330	mt.	1,134
001 004 010010 20 00	10X10 MM KABLO KANALI EKO KENDİNDEN KAPAKLI (YAPIŞKAN BANTLI)	320	mt.	1,493
001 004 012012 20 00	12X12 MM KABLO KANALI EKO (YAPIŞKAN BANTLI)	250	mt.	1,191
001 004 015010 20 00	15X10 MM KABLO KANALI EKO (YAPIŞKAN BANTLI)	230	mt.	1,274
001 004 016016 20 00	16X16 MM KABLO KANALI EKO (YAPIŞKAN BANTLI)	230	mt.	1,695
001 004 020010 20 00	20X10 MM KABLO KANALI EKO (YAPIŞKAN BANTLI)	180	mt.	1,497
001 004 025016 20 00	25X16 MM KABLO KANALI EKO (YAPIŞKAN BANTLI)	150	mt.	2,356
001 004 025025 20 00	25X25 MM KABLO KANALI EKO (YAPIŞKAN BANTLI)	100	mt.	2,910
001 004 025040 20 00	25X40 MM KABLO KANALI EKO (YAPIŞKAN BANTLI)	80	mt.	5,139
001 004 930010 20 00	30X10 MM KABLO KANALI EKO (YAPIŞKAN BANTLI) (BÖLMELİ)	140	mt.	2,733
001 004 030016 20 00	30X16 MM KABLO KANALI EKO (YAPIŞKAN BANTLI)	140	mt.	3,071
001 004 030025 20 00	30X25 MM KABLO KANALI EKO (YAPIŞKAN BANTLI)	80	mt.	3,479
001 004 040016 20 00	40X16 MM KABLO KANALI EKO (YAPIŞKAN BANTLI)	100	mt.	3,805
001 004 040025 20 00	40X25 MM KABLO KANALI EKO (YAPIŞKAN BANTLI)	80	mt.	4,631
001 004 040040 20 00	40X40 MM KABLO KANALI EKO (YAPIŞKAN BANTLI)	50	mt.	5,325
001 004 060040 20 00	60X40 MM KABLO KANALI EKO (YAPIŞKAN BANTLI)	40	mt.	8,096
001 004 060015 20 17	60X15 MM KABLO KANALI BALIK SIRTİ (YAPIŞKAN BANTLI)	40	mt.	6,879
001 004 075018 20 17	75X18 MM KABLO KANALI BALIK SIRTİ (YAPIŞKAN BANTLI)	30	mt.	11,410
001 004 090020 20 17	90X20 MM KABLO KANALI BALIK SIRTİ (YAPIŞKAN BANTLI)	20	mt.	13,385

Kod	Açıklama / Stok Cinsi	Amb. (Kutu)	Amb. Birimi	FİYAT
H.FREE MEKSPUS SERİSİ KAPALI TİP KABLO KANALLARI   IP40  				
001 060 100050 20 00	100X50 MM KABLO KANALI İÇTEN KAPAKLI HALOJEN FREE	20	mt.	53,546
001 061 100050 20 00	100X50 MM KABLO KANALI ARA BÖLME HALOJEN FREE	150	mt.	5,650
001 039 100050 11 00	100X50-37 MM KABLO KANALI İÇ KÖŞE(HAREKETLİ) HALOJEN FREE	12	ad.	7,345
001 040 100050 11 00	100X50 MM KABLO KANALI DIŞ KÖŞE(HAREKETLİ) HALOJEN FREE	10	ad.	8,960
001 041 100050 11 00	100X50 MM KABLO KANALI T PARÇASI HALOJEN FREE	8	ad.	8,028
001 042 100050 11 00	100X50 MM KABLO KANALI 90 L KÖŞE HALOJEN FREE	8	ad.	7,745
001 043 100050 11 00	100X50 MM KABLO KANALI EK PARÇA(ÜÇLÜ SET) HALOJEN FREE	100	ad.	1,595
001 044 100050 11 00	100X50 MM KABLO KANALI UÇ TAPA HALOJEN FREE	40	ad.	3,256
001 047 100001 11 00	PMS(100X37/50)(45X45)(1LÜ) HALOJEN FREE	20	ad.	5,632
001 047 100002 11 00	PMS(100X37/50)(45X45)(2LÜ) HALOJEN FREE	14	ad.	7,215
001 047 100003 11 00	PMS(100X37/50)(45X45)(3LÜ) HALOJEN FREE	12	ad.	9,580
H.FREE SERİSİ KAPALI TİP KABLO KANALLARI  IP40  				
001 060 025016 20 00	25X16 MM KABLO KANALI HALOJEN FREE	150	mt.	8,500
001 060 025025 20 00	25X25 MM KABLO KANALI HALOJEN FREE	100	mt.	8,800
001 060 040025 20 00	40X25 MM KABLO KANALI HALOJEN FREE	80	mt.	12,560
001 060 040040 20 00	40X40 MM KABLO KANALI HALOJEN FREE	50	mt.	16,323
MEKS SERİSİ TSE'Lİ KAPALI TİP KABLO KANALLARI   IP40  				
001 002 015015 20 00	15X15 MM KABLO KANALI MEKS	250	mt.	1,670
001 002 016016 20 00	16X16 MM KABLO KANALI MEKS	250	mt.	1,780
001 002 025016 20 00	25X16 MM KABLO KANALI MEKS	150	mt.	2,378
001 002 025025 20 00	25X25 MM KABLO KANALI MEKS	100	mt.	3,145
001 002 030015 20 00	30X15 MM KABLO KANALI MEKS	140	mt.	3,340
001 002 030030 20 00	30X30 MM KABLO KANALI MEKS	80	mt.	3,520
001 002 040017 20 00	40X17 MM KABLO KANALI TAM KAPAKLI MEKS	100	mt.	4,428
001 002 040025 20 00	40X25 MM KABLO KANALI MEKS	80	mt.	4,377
001 002 040040 20 00	40X40 MM KABLO KANALI MEKS	50	mt.	5,617
001 002 960025 20 00	60X25 MM KABLO KANALI MEKS (BÖLMELİ)	40	mt.	7,130
001 002 060040 20 00	60X40 MM KABLO KANALI MEKS	40	mt.	7,212
001 002 975022 20 00	75X22 MM KABLO KANALI MEKS (BÖLMELİ)	50	mt.	11,343
001 002 080060 20 00	80X60 MM KABLO KANALI MEKS	24	mt.	11,660
001 002 100036 20 00	100X36 MM KABLO KANALI MEKS	30	mt.	16,275
001 002 100040 20 00	100X40 MM KABLO KANALI MEKS	24	mt.	13,146
001 002 100048 20 00	100X48 MM KABLO KANALI MEKS	24	mt.	18,292
001 002 120070 20 00	120X70 MM KABLO KANALI (İÇTEN KAPAKLI)(AKSESUARISIZ)	16	mt.	25,700
001 002 170070 20 00	170X70 MM KABLO KANALI (İÇTEN KAPAKLI)(AKSESUARISIZ)	8	mt.	33,510
001 002 250070 20 00	250X70 MM KABLO KANALI (İÇTEN KAPAKLI)(AKSESUARISIZ)	8	mt.	52,254
001 002 100060 20 00	100X60 MM KABLO KANALI MEKS	20	mt.	18,168
001 002 120060 20 00	120X60 MM KABLO KANALI MEKS	16	mt.	22,568
MEKS SERİSİ KAPALI TİP KABLO KANALLARI   IP40  				
001 002 100037 20 00	100X37 MM KABLO KANALI MEKS (İÇTEN KAPAKLI)(FOLYOLU)	30	mt.	15,956
001 002 100041 20 00	100X41 MM KABLO KANALI MEKS (İÇTEN KAPAKLI)(FOLYOLU)	24	mt.	16,133
001 002 100050 20 00	100X50 MM KABLO KANALI MEKS (İÇTEN KAPAKLI)(FOLYOLU)	20	mt.	18,094
MEKSPUS SERİSİ KAPALI TİP KABLO KANALLARI   IP40  				
001 003 040025 20 00	40X25 MM KABLO KANALI (İÇTEN KAPAKLI)	80	mt.	5,959
001 003 100037 20 00	100X37 MM KABLO KANALI (İÇTEN KAPAKLI)	30	mt.	15,301
001 003 100041 20 00	100X41 MM KABLO KANALI (İÇTEN KAPAKLI)	24	mt.	15,708
001 003 100050 20 00	100X50 MM KABLO KANALI (İÇTEN KAPAKLI)(2MM KABLO KANALI EK KALIN)	20	mt.	19,749
001 003 120070 20 00	120X70 MM KABLO KANALI (İÇTEN KAPAKLI)(AKSESUARISIZ)	16	mt.	25,284
001 003 170050 20 00	170X50 MM KABLO KANALI (İÇTEN KAPAKLI)	12	mt.	35,034
001 003 170070 20 00	170X70 MM KABLO KANALI (İÇTEN KAPAKLI)(AKSESUARISIZ)	8	mt.	40,117
001 003 250070 20 00	250X70 MM KABLO KANALI (İÇTEN KAPAKLI)(AKSESUARISIZ)	8	mt.	58,715
001 006 100050 20 00	100X50 MM KABLO KANALI (İÇTEN KAPAKLI)(KPMS SERİSİ)	20	mt.	24,529
001 888 100050 00 00	100X50 MM KABLO KANALI KPMS MONTAJ APARATI	50	mt.	2,178
MEKS SERİSİ KLİMA KANALI VE AKSESUARLARI   IP40  				
001 002 075060 20 00	75X60 MM KLİMA KANALI	30	mt.	11,500
001 050 030002 00 00	KLİMA KANALI KABLO TUTUCUSU	60	ad.	1,189
001 043 075060 00 00	KLİMA KANALI EK PARÇASI	40	ad.	1,222
001 039 075060 00 00	KLİMA KANALI İÇ KÖŞE	24	ad.	2,764
001 040 075060 00 00	KLİMA KANALI DIŞ KÖŞE	24	ad.	2,325
001 042 075060 00 00	KLİMA KANALI L KÖŞE	18	ad.	2,994
001 050 030001 00 00	KLİMA KANALI DUVAR GEÇİŞİ	60	ad.	1,362
001 044 075060 01 00	KLİMA KANALI İÇ SONLAMA	30	ad.	1,986
001 044 075060 02 00	KLİMA KANALI DIŞ SONLAMA	18	ad.	2,033
TAVAN KÖŞE KANALI   IP40  				
001 002 023023 20 00	23X23 MM TAVAN KÖŞE KANALI	120	mt.	3,741
FUGALI SÜPÜRGELİK   IP40  				
001 010 000200 20 00	50'LİK FUGALI SÜPÜRGELİK	60	mt.	2,661
TEZGAH SÜPÜRGELİĞİ   IP40  				
001 011 000100 00 00	25'LİK TEZGAH SÜPÜRGELİĞİ 100CM	60	mt.	4,969
BALIK SIRTİ ZEMİN KANALLARI   IP40  				
001 002 060015 20 17	60X15 MM BALIK SIRTİ KANAL (ZEMİN İÇİN)	40	mt.	5,985
001 042 060015 00 17	60X15 MM BALIK SIRTİ KANAL L KÖŞE	24	ad.	1,725
001 043 060015 00 17	60X15 MM BALIK SIRTİ KANAL EK PARÇASI	50	ad.	1,097
001 044 060015 00 17	60X15 MM BALIK SIRTİ KANAL SONLAMA KAPAĞI	50	ad.	1,038
001 041 060015 00 17	60X15 MM BALIK SIRTİ KANAL T KÖŞE	10	ad.	3,431
001 002 075018 20 17	75X18 MM BALIK SIRTİ KANAL (ZEMİN İÇİN)	30	mt.	10,362
001 042 075018 00 17	75X18 MM BALIK SIRTİ KANAL L KÖŞE	15	ad.	1,640
001 043 075018 00 17	75X18 MM BALIK SIRTİ KANAL EK PARÇASI	50	ad.	0,874
001 044 075018 00 17	75X18 MM BALIK SIRTİ KANAL SONLAMA KAPAĞI	50	ad.	0,925
001 041 075018 00 17	75X18 MM BALIK SIRTİ KANAL T KÖŞE	8	ad.	3,104
001 002 090020 20 17	90X20 MM BALIK SIRTİ KANAL (ZEMİN İÇİN)	20	mt.	12,858
001 042 090020 00 17	90X20 MM BALIK SIRTİ KANAL KANAL L KÖŞE	20	ad.	2,031
001 043 090020 00 17	90X20 MM BALIK SIRTİ KANAL EK PARÇASI	50	ad.	0,902
001 044 090020 00 17	90X20 MM BALIK SIRTİ KANAL SONLAMA KAPAĞI	50	ad.	0,902
001 041 090020 00 17	90X20 MM BALIK SIRTİ KANAL T KÖŞE	12	ad.	3,612





Kod	Açıklama / Stok Cinsi	Amb. (Kutu)	Amb. Birimi	FİYAT
12X12 KANAL AKSESUARLARI				
TS CE IP40				
001 039 012012 00 00	12X12 MM İÇ KÖŞE	60	ad.	0,809
001 040 012012 00 00	12X12 MM DIŞ KÖŞE	60	ad.	0,809
001 041 012012 00 00	12X12 MM T KÖŞE	60	ad.	0,809
001 042 012012 00 00	12X12 MM 90 L KÖŞE	60	ad.	0,809
001 044 012012 00 00	12X12 MM UÇ TAPA	100	ad.	0,809
001 043 012012 00 00	12X12 MM EK PARÇASI	100	ad.	0,809
15X10 KANAL AKSESUARLARI				
TS CE IP40				
001 039 015010 00 00	15X10 MM İÇ KÖŞE	60	ad.	0,858
001 040 015010 00 00	15X10 MM DIŞ KÖŞE	60	ad.	0,858
001 041 015010 00 00	15X10 MM T KÖŞE	60	ad.	0,858
001 042 015010 00 00	15X10 MM 90 L KÖŞE	60	ad.	0,858
001 044 015010 00 00	15X10 MM UÇ TAPA	100	ad.	0,858
001 043 016016 00 00	15X10 MM EK PARÇASI	100	ad.	0,858
20X10 KANAL AKSESUARLARI				
TS CE IP40				
001 039 020010 00 00	20X10 MM İÇ KÖŞE	60	ad.	0,870
001 040 020010 00 00	20X10 MM DIŞ KÖŞE	60	ad.	0,870
001 041 020010 00 00	20X10 MM T KÖŞE	30	ad.	0,870
001 042 020010 00 00	20X10 MM 90 L KÖŞE	50	ad.	0,870
001 044 020010 00 00	20X10 MM UÇ TAPA	100	ad.	0,870
001 043 020010 00 00	20X10 MM EK PARÇASI	100	ad.	0,870
16X16 KANAL AKSESUARLARI				
TS CE IP40				
001 039 016016 00 00	16X16 MM İÇ KÖŞE	60	ad.	0,839
001 040 016016 00 00	16X16 MM DIŞ KÖŞE	60	ad.	0,839
001 041 016016 00 00	16X16 MM T KÖŞE	60	ad.	1,391
001 042 016016 00 00	16X16 MM 90 L KÖŞE	60	ad.	0,839
001 044 016016 00 00	16X16 MM UÇ TAPA	100	ad.	0,839
001 043 016016 00 00	16X16 MM EK PARÇASI	100	ad.	0,823
25X16 KANAL AKSESUARLARI				
TS CE IP40				
001 039 025016 00 00	25X16 MM İÇ KÖŞE	40	ad.	0,991
001 040 025016 00 00	25X16 MM DIŞ KÖŞE	40	ad.	0,936
001 041 025016 00 00	25X16 MM T KÖŞE	30	ad.	1,640
001 042 025016 00 00	25X16 MM 90 L KÖŞE	50	ad.	1,016
001 044 025016 00 00	25X16 MM UÇ TAPA	100	ad.	0,914
001 043 025016 00 00	25X16 MM EK PARÇA	100	ad.	0,914
001 047 017421 00 00	25X16 MM PMK (45X45)	12	ad.	13,437
25X25 KANAL AKSESUARLARI				
TS CE IP40				
001 039 025025 00 00	25X25 MM İÇ KÖŞE	40	ad.	0,961
001 040 025025 00 00	25X25 MM DIŞ KÖŞE	40	ad.	0,961
001 041 025025 00 00	25X25 MM T PARÇASI	24	ad.	1,752
001 042 025025 00 00	25X25 MM 90 L KÖŞE	40	ad.	1,041
001 044 025025 00 00	25X25 MM UÇ TAPA	100	ad.	0,961
001 043 025025 00 00	25X25 MM EK PARÇA	50	ad.	0,961
001 047 017421 00 00	25X25 MM PMK (45X45)	12	ad.	13,437
30X10 KANAL AKSESUARLARI				
TS CE IP40				
001 039 030010 00 00	30X10 MM İÇ KÖŞE	50	ad.	2,072
001 040 030010 00 00	30X10 MM DIŞ KÖŞE	50	ad.	2,072
001 041 030010 00 00	30X10 MM T PARÇASI	50	ad.	2,072
001 042 030010 00 00	30X10 MM 90 L KÖŞE	50	ad.	1,440
001 044 030010 00 00	30X10 MM UÇ TAPA	100	ad.	1,175
001 043 030010 00 00	30X10 MM EK PARÇA	100	ad.	1,219
30X16 KANAL AKSESUARLARI				
TS CE IP40				
001 039 030016 00 00	30X16 MM İÇ KÖŞE	35	ad.	2,156
001 040 030016 00 00	30X16 MM DIŞ KÖŞE	48	ad.	2,156
001 041 030016 00 00	30X16 MM T PARÇASI	40	ad.	1,657
001 042 030016 00 00	30X16 MM 90 L KÖŞE	50	ad.	1,740
001 044 030016 00 00	30X16 MM UÇ TAPA	100	ad.	1,473
001 043 030016 00 00	30X16 MM EK PARÇA	100	ad.	1,473
30X25 KANAL AKSESUARLARI				
TS CE IP40				
001 039 030025 00 00	30X25 MM İÇ KÖŞE	30	ad.	2,439
001 040 030025 00 00	30X25 MM DIŞ KÖŞE	32	ad.	2,439
001 041 030025 00 00	30X25 MM T PARÇASI	24	ad.	1,850
001 042 030025 00 00	30X25 MM 90 L KÖŞE	30	ad.	1,896
001 044 030025 00 00	30X25 MM UÇ TAPA	100	ad.	1,297
001 043 030025 00 00	30X25 MM EK PARÇA	100	ad.	1,219
40X16 KANAL AKSESUARLARI				
TS CE IP40				
001 039 040016 00 00	40X16 MM İÇ KÖŞE	32	ad.	2,211
001 040 040016 00 00	40X16 MM DIŞ KÖŞE	30	ad.	2,211
001 041 040016 00 00	40X16 MM T KÖŞE	24	ad.	1,450
001 042 040016 00 00	40X16 MM 90 L KÖŞE	34	ad.	1,450
001 044 040016 00 00	40X16 MM UÇ TAPA	25	ad.	1,602
001 043 040016 00 00	40X16 MM EK PARÇASI	100	ad.	1,450
001 047 017421 00 00	40X16 MM PMK (45X45)	12	ad.	13,437
40X25 KANAL AKSESUARLARI				
TS CE IP40				
001 039 040025 00 00	40X25 MM İÇ KÖŞE	24	ad.	2,384
001 040 040025 00 00	40X25 MM DIŞ KÖŞE	30	ad.	2,384
001 041 040025 00 00	40X25 MM T KÖŞE	18	ad.	1,525
001 042 040025 00 00	40X25 MM 90 L KÖŞE	24	ad.	1,525
001 044 040025 00 00	40X25 MM UÇ TAPA	25	ad.	1,602
001 043 040016 00 00	40X25 MM EK PARÇASI	70	ad.	1,450
001 047 017421 00 00	40X25 MM PMK (45X45)	12	ad.	13,437

Kod	Açıklama / Stok Cinsi	Amb. (Kutu)	Amb. Birimi	FİYAT
40X40 KANAL AKSESUARLARI 				
001 039 040040 00 00	40X40 MM İÇ KÖŞE	18	ad.	1,736
001 040 040040 00 00	40X40 MM DIŞ KÖŞE	10	ad.	2,690
001 041 040040 00 00	40X40 MM T PARÇASI	48	ad.	1,799
001 042 040040 00 00	40X40 MM 90 L KÖŞE	60	ad.	1,602
001 044 040040 00 00	40X40 MM UÇ TAPA	25	ad.	1,602
001 043 040016 00 00	40X40 MM EK PARÇA	100	ad.	1,450
001 047 017421 00 00	40X40 MM PMK (45X45)	12	ad.	13,437
75X22 KANAL AKSESUARLARI 				
001 039 075022 00 00	75X22 MM İÇ KÖŞE	20	ad.	1,883
001 040 075022 00 00	75X22 MM DIŞ KÖŞE	20	ad.	1,883
001 044 075022 01 00	75X22 MM SAĞ SONLAMA	30	ad.	1,883
001 044 075022 02 00	75X22 MM SOL SONLAMA	20	ad.	1,883
001 043 075022 00 00	75X22 MM EK PARÇASI	100	ad.	1,883
60X25 KANAL AKSESUARLARI 				
001 039 060025 00 00	60X25 MM İÇ KÖŞE	48	ad.	3,793
001 040 060025 00 00	60X25 MM DIŞ KÖŞE	72	ad.	3,793
001 041 060025 00 00	60X25 MM T PARÇASI	40	ad.	3,793
001 042 060025 00 00	60X25 MM 90 L KÖŞE	60	ad.	3,793
001 044 060025 00 00	60X25 MM UÇ TAPA	50	ad.	2,046
001 043 060025 00 00	60X25 MM EK PARÇA	60	ad.	1,594
60X40 KANAL AKSESUARLARI 				
001 039 060040 00 00	60X40 MM İÇ KÖŞE	26	ad.	3,793
001 040 060040 00 00	60X40 MM DIŞ KÖŞE	32	ad.	3,793
001 041 060040 00 00	60X40 MM T PARÇASI	32	ad.	3,793
001 042 060040 00 00	60X40 MM 90 L KÖŞE	40	ad.	3,793
001 044 060040 00 00	60X40 MM UÇ TAPA	50	ad.	1,616
001 043 060040 00 00	60X40 MM EK PARÇA	40	ad.	1,765
60X60 KANAL AKSESUARLARI 				
001 039 060060 01 00	60X60 MM İÇ KÖŞE (HAREKETLİ)	16	ad.	4,605
001 040 060060 01 00	60X60 MM DIŞ KÖŞE (HAREKETLİ)	16	ad.	4,974
001 041 060060 00 00	60X60 MM T PARÇASI	20	ad.	4,605
001 042 060060 00 00	60X60 MM 90 L KÖŞE	24	ad.	4,605
001 044 060060 00 00	60X60 MM UÇ TAPA	30	ad.	2,306
001 043 060060 00 00	60X60 MM EK PARÇA	25	ad.	1,649
80X40 KANAL AKSESUARLARI 				
001 039 080040 00 00	80X40 MM İÇ KÖŞE	18	ad.	5,379
001 040 080040 00 00	80X40 MM DIŞ KÖŞE	8	ad.	5,379
001 041 080040 00 00	80X40 MM T PARÇASI	12	ad.	5,379
001 042 080040 00 00	80X40 MM 90 L KÖŞE	16	ad.	5,579
001 044 080040 00 00	80X40 MM UÇ TAPA	60	ad.	2,093
001 043 080040 00 00	80X40 MM EK PARÇA	100	ad.	1,992
80X60 KANAL AKSESUARLARI 				
001 039 080060 00 00	80X60 MM İÇ KÖŞE	12	ad.	5,547
001 040 080060 00 00	80X60 MM DIŞ KÖŞE	8	ad.	5,547
001 041 080060 00 00	80X60 MM T PARÇASI	10	ad.	6,078
001 042 080060 00 00	80X60 MM 90 L KÖŞE	12	ad.	5,547
001 044 080060 00 00	80X60 MM UÇ TAPA	48	ad.	2,292
001 043 080060 00 00	80X60 MM EK PARÇA	80	ad.	2,511
100X36 KANAL AKSESUARLARI 				
001 039 100036 00 00	100X36 MM İÇ KÖŞE (SABİT)	8	ad.	6,078
001 040 100036 00 00	100X36 MM DIŞ KÖŞE (SABİT)	8	ad.	6,078
001 039 100040 01 00	100X36 MM İÇ KÖŞE (HAREKETLİ)	8	ad.	6,078
001 040 100040 01 00	100X36 MM DIŞ KÖŞE (HAREKETLİ)	10	ad.	6,078
001 041 100036 00 00	100X36 MM T PARÇASI	12	ad.	6,078
001 042 100036 00 00	100X36 MM 90 L KÖŞE	12	ad.	6,078
001 044 100036 00 00	100X36 MM UÇ TAPA	200	ad.	2,873
001 043 100036 00 00	100X36 MM EK PARÇA	100	ad.	2,588
001 050 030004 00 00	100X36 MM KANAL KİLİTLEME APARATI	100	ad.	0,708
001 013 100036 20 00	100X36 MM ARA BÖLME	200	mt.	3,108
100X37 KANAL AKSESUARLARI 				
001 039 100037 00 00	100X37 MM İÇ KÖŞE (SABİT)	12	ad.	4,899
001 040 100037 00 00	100X37 MM DIŞ KÖŞE (SABİT)	8	ad.	4,899
001 039 100050 01 00	100X37 MM İÇ KÖŞE (HAREKETLİ)	12	ad.	5,150
001 040 100050 01 00	100X37 MM DIŞ KÖŞE (HAREKETLİ)	10	ad.	6,010
001 041 100037 00 00	100X37 MM T PARÇASI	12	ad.	4,899
001 042 100037 00 00	100X37 MM 90 L KÖŞE	12	ad.	4,899
001 044 100037 00 00	100X37 MM UÇ TAPA	50	ad.	2,394
001 043 100037 00 00	100X37 MM EK PARÇA	100	ad.	1,660
100X40 KANAL AKSESUARLARI 				
001 039 100040 00 00	100X40 MM İÇ KÖŞE (SABİT)	8	ad.	4,862
001 040 100040 00 00	100X40 MM DIŞ KÖŞE (SABİT)	8	ad.	5,213
001 039 100040 01 00	100X40 MM İÇ KÖŞE (HAREKETLİ)	8	ad.	4,862
001 040 100040 01 00	100X40 MM DIŞ KÖŞE (HAREKETLİ)	10	ad.	4,862
001 041 100040 00 00	100X40 MM T PARÇASI	12	ad.	5,875
001 042 100040 00 00	100X40 MM 90 L KÖŞE	12	ad.	4,862
001 044 100040 00 00	100X40 MM UÇ TAPA	20	ad.	2,298
001 043 100040 00 00	100X40 MM EK PARÇA	100	ad.	2,000
001 050 030004 00 00	100X40 MM KANAL KİLİTLEME APARATI	100	ad.	0,566
001 013 100040 20 00	100X40 MM ARA BÖLME	200	mt.	2,781

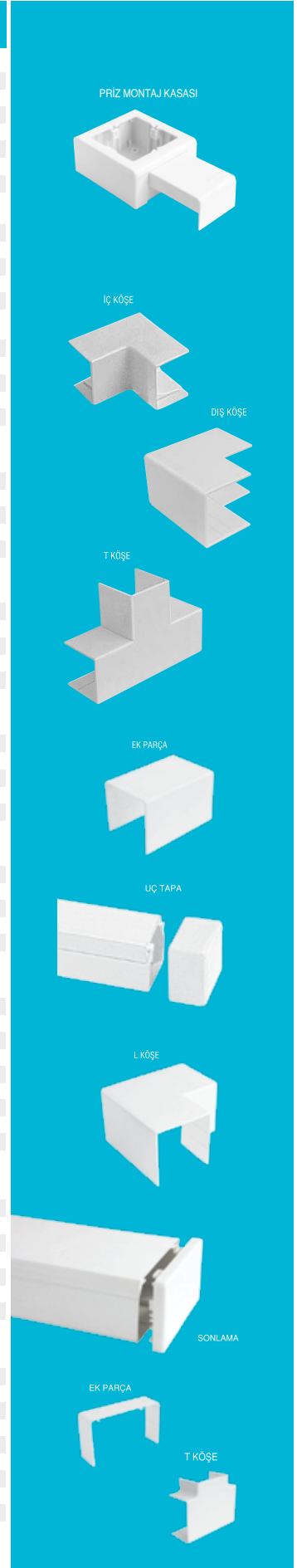



Kod	Açıklama / Stok Cinsi	Amb. (Kutu)	Amb. Birimi	FİYAT
KANAL İÇİN UPS VE ENERJİ PRİZLERİ (45X45) TSE'Li				
001 052 300001 00 00	45X45 TOP.P.ÇEKİRDEĞİ ÇÇK.KOR.(45")	50	ad.	4,950
001 052 300002 00 00	45X45 UPS P.ÇEKİRDEĞİ ÇÇK.KOR.(45")	50	ad.	5,280
001 052 200005 00 00	45X45 PRİZ BİRLEŞTİRME APARATI	50	ad.	2,925
888 049 050008	DATA KONNEKTÖRÜ CAT 5e (RJ65 8)	1	ad.	1,529\$
888 049 050032	DATA KONNEKTÖRÜ CAT 6e (RJ65 8)	1	ad.	2,201\$
888 049 050009	TELEFON KONNEKTÖRÜ (RJ 11/12 6)	1	ad.	1,345\$
888 049 050013	45X45 DATA PRİZ KAPAĞI	1	ad.	0,832\$
888 049 050012	45X22,5 DATA PRİZ KAPAĞI	1	ad.	0,685\$
DÖŞEME ALTI PRİZ SİSTEMLERİ				
075 171 222508	8 MOD. DÖŞ. ALTI PRİZ S.(BOŞ) 221X255	1	ad.	60,572
075 171 333308	8 MOD. DÖŞ. ALTI PRİZ S.BUAT 330X330	1	ad.	65,482
075 171 272712	12 MOD. DÖŞ. ALTI PRİZ S.(BOŞ) 270X270	1	ad.	83,490
075 171 424212	12 MOD. DÖŞ. ALTI PRİZ S.BUAT 420X420	1	ad.	91,675
100X48 KANAL AKSESUARLARI				
001 039 100048 00 00	100X48 MM İÇ KÖŞE (SABİT)	8	ad.	6,529
001 040 100048 00 00	100X48 MM DIŞ KÖŞE (SABİT)	8	ad.	6,529
001 039 100060 01 00	100X48 MM İÇ KÖŞE (HAREKETLİ)	8	ad.	6,509
001 040 100060 01 00	100X48 MM DIŞ KÖŞE (HAREKETLİ)	10	ad.	6,509
001 041 100048 00 00	100X48 MM T PARÇASI	8	ad.	6,509
001 042 100048 00 00	100X48 MM 90 L KÖŞE	8	ad.	6,509
001 044 100048 00 00	100X48 MM UÇ TAPA	20	ad.	2,298
001 043 100048 00 00	100X48 MM EK PARÇA	100	ad.	1,515
001 050 030004 00 00	100X48 MM KANAL KİLİTLEME APARATI	100	ad.	0,566
001 013 100048 20 00	100X48 MM ARA BÖLME	150	mt.	2,455
100X60 KANAL AKSESUARLARI				
001 039 100060 00 00	100X60 MM İÇ KÖŞE (SABİT)	8	ad.	5,579
001 040 100060 00 00	100X60 MM DIŞ KÖŞE (SABİT)	8	ad.	5,579
001 039 100060 01 00	100X60 MM İÇ KÖŞE (HAREKETLİ)	8	ad.	5,387
001 040 100060 01 00	100X60 MM DIŞ KÖŞE (HAREKETLİ)	10	ad.	5,387
001 041 100060 00 00	100X60 MM T PARÇASI	8	ad.	5,943
001 042 100060 00 00	100X60 MM 90 L KÖŞE	8	ad.	5,579
001 044 100060 00 00	100X60 MM UÇ TAPA	20	ad.	2,298
001 043 100060 00 00	100X60 MM EK PARÇA	100	ad.	1,518
001 050 030004 00 00	100X60 MM KANAL KİLİTLEME APARATI	100	ad.	0,566
001 013 100060 20 00	100X60 MM ARA BÖLME	130	mt.	3,461
100X50 KANAL AKSESUARLARI				
001 039 100050 00 00	100X50 MM İÇ KÖŞE (SABİT)	8	ad.	4,782
001 040 100050 00 00	100X50 MM DIŞ KÖŞE (SABİT)	8	ad.	4,782
001 039 100050 01 00	100X50 MM İÇ KÖŞE (HAREKETLİ)	12	ad.	6,491
001 040 100050 01 00	100X50 MM DIŞ KÖŞE (HAREKETLİ)	10	ad.	6,491
001 041 100050 00 00	100X50 MM T PARÇASI	8	ad.	6,576
001 042 100050 00 00	100X50 MM 90 L KÖŞE	8	ad.	6,491
001 044 100050 00 00	100X50 MM UÇ TAPA	40	ad.	2,710
001 043 100050 00 00	100X50 MM EK PARÇA	100	ad.	1,913
001 043 100050 01 00	100X50 MM EK PARÇA (3LÜ SET)	100	ad.	1,913
001 046 195100 00 00	100X50 MM KANAL İÇİ KÜP BUAT	25	ad.	3,904
100X50 KAİDESİZ KANAL AKSESUARLARI				
001 039 100051 00 00	100X50 MM KAİDESİZ İÇ KÖŞE	8	ad.	3,983
001 040 100051 00 00	100X50 MM KAİDESİZ DIŞ KÖŞE	8	ad.	3,985
001 041 100051 00 00	100X50 MM KAİDESİZ T PARÇASI	8	ad.	4,450
001 042 100051 00 00	100X50 MM KAİDESİZ 90 L KÖŞE	8	ad.	4,025
001 043 100051 00 00	100X50 MM KAİDESİZ EK PARÇA	100	ad.	1,260
001 044 100051 00 00	100X50 MM KAİDESİZ UÇ TAPA	40	ad.	1,600
120X60 KANAL AKSESUARLARI				
001 039 120060 00 00	120X60 MM İÇ KÖŞE	8	ad.	5,898
001 040 120060 00 00	120X60 MM DIŞ KÖŞE	8	ad.	5,898
001 041 120060 00 00	120X60 MM T PARÇA	8	ad.	5,898
001 042 120060 00 00	120X60 MM 90 L KÖŞE	8	ad.	5,898
001 044 120060 00 00	120X60 MM UÇ TAPA	20	ad.	2,298
001 043 120060 00 00	120X60 MM EK PARÇA	50	ad.	1,699
İÇTEN KAPAKLI 100X37/50 İÇİN PRİZ MONTAJ SETİ (45x45)				
001 047 070001 00 00	100X37/50 İÇİN 45X45 PMS (TEKLİ)	20	ad.	4,343
001 047 070002 00 00	100X37/50 İÇİN 45X45 PMS (İKİLİ)	14	ad.	5,500
001 047 070003 00 00	100X37/50 İÇİN 45X45 PMS (ÜÇLÜ)	12	ad.	5,738
001 047 070004 00 00	100X37/50 İÇİN 45X45 PMS (DÖRTLÜ)	10	ad.	6,646
İÇTEN KAPAKLI 100X37/50 İÇİN PRİZ MONTAJ SETİ (55X55)				
001 047 080001 00 00	100X37/50 İÇİN 55X55 PMS (TEKLİ)	20	ad.	4,438
001 047 080002 00 00	100X37/50 İÇİN 55X55 PMS (İKİLİ)	14	ad.	6,141
001 047 080003 00 00	100X37/50 İÇİN 55X55 PMS (ÜÇLÜ)	12	ad.	7,053
DIŞTAN KAPAKLI 100'LÜK KANAL PRİZ MONTAJ SETİ (55X55)				
001 047 020001 00 00	100'LÜK 55X55 PMS TEKLİ	20	ad.	5,429
001 047 020002 00 00	100'LÜK 55X55 PMS İKİLİ	14	ad.	6,815
001 047 020003 00 00	100'LÜK 55X55 PMS ÜÇLÜ	12	ad.	8,766
DIŞTAN KAPAKLI 100'LÜK KANAL PRİZ MONTAJ SETİ (45x45)				
001 047 040001 00 00	100'LÜK 45X45 PMS TEKLİ	20	ad.	4,886
001 047 040002 00 00	100'LÜK 45X45 PMS İKİLİ	14	ad.	5,496
001 047 040003 00 00	100'LÜK 45X45 PMS ÜÇLÜ	12	ad.	6,276
001 047 040004 00 00	100'LÜK 45X45 PMS DÖRTLÜ	10	ad.	7,083

Kod	Açıklama / Stok Cinsi	Amb. (Kutu)	Amb. Birimi	FİYAT
SİDEM SERİSİ RENKLİ KABLO KANALLARI 				
001 007 010008 20 01	10X8 MM KABLO KANALI (SİDEM)	330	mt.	4,040
001 007 012012 20 01	12X12 MM KABLO KANALI (SİDEM)	250	mt.	4,250
001 007 015010 20 01	15X10 MM KABLO KANALI (SİDEM)	250	mt.	4,056
001 007 016016 20 01	16X16 MM KABLO KANALI (SİDEM)	250	mt.	4,850
001 007 020010 20 01	20X10 MM KABLO KANALI (SİDEM)	200	mt.	4,279
001 007 025016 20 01	25X16 MM KABLO KANALI (SİDEM)	150	mt.	5,706
001 007 025025 20 01	25X25 MM KABLO KANALI (SİDEM)	100	mt.	7,652
001 007 930010 20 01	30X10 MM KABLO KANALI (SİDEM) BÖLMELİ	140	mt.	5,915
001 007 930016 20 01	30X16 MM KABLO KANALI (SİDEM) BÖLMELİ	140	mt.	7,559
001 007 030025 20 01	30X25 MM KABLO KANALI (SİDEM)	80	mt.	8,158
001 007 040016 20 01	40X16 MM KABLO KANALI (SİDEM)	100	mt.	7,616
001 007 940016 20 01	40X16 MM KABLO KANALI (SİDEM) (BÖLMELİ)	100	mt.	8,495
001 007 040025 20 01	40X25 MM KABLO KANALI (SİDEM)	80	mt.	10,052
001 007 040040 20 01	40X40 MM KABLO KANALI (SİDEM)	50	mt.	12,581
001 007 960025 20 01	60X25 MM KABLO KANALI (SİDEM) BÖLMELİ	40	mt.	15,005
001 007 060040 20 01	60X40 MM KABLO KANALI (SİDEM)	40	mt.	15,642
001 007 060060 20 01	60X60 MM KABLO KANALI (SİDEM)	32	mt.	21,809
001 007 975022 20 01	75X22 MM KABLO KANALI (SİDEM) BÖLMELİ	50	mt.	19,075
001 007 080040 20 01	80X40 MM KABLO KANALI (SİDEM)	30	mt.	20,679
001 007 080060 20 01	80X60 MM KABLO KANALI (SİDEM)	24	mt.	24,933
001 007 100036 20 01	100X36 MM KABLO KANALI (SİDEM)	30	mt.	27,350
001 007 100040 20 01	100X40 MM KABLO KANALI (SİDEM)	24	mt.	22,590
001 007 100048 20 01	100X48 MM KABLO KANALI (SİDEM)	24	mt.	30,082
001 007 100060 20 01	100X60 MM KABLO KANALI (SİDEM)	20	mt.	32,327
001 007 075060 20 01	75X60 MM KABLO KANALI (SİDEM)	30	mt.	24,373
001 007 100037 20 01	100X37 MM KABLO KANALI (SİDEM) İ.KAPAKLI	30	mt.	26,488
001 007 100050 20 01	100X50 MM KABLO KANALI (SİDEM) İ.KAPAKLI	20	mt.	30,426
001 007 120060 20 01	120X60 MM KABLO KANALI (SİDEM) İ.KAPAKLI	16	mt.	37,301
001 007 120070 20 01	120X70 MM KABLO KANALI (SİDEM)	16	mt.	54,342
001 007 170070 20 01	170X70 MM KABLO KANALI (SİDEM)	12	mt.	56,994

SİDEM SERİSİ RENKLİ KABLO KANALLARI (YAPIŞKANLI)

001 155 010008 20 01	10X8 MM KABLO KANALI (SİDEM) YAPIŞKANLI	330	mt.	4,268
001 155 012012 20 01	12X12 MM KABLO KANALI (SİDEM) YAPIŞKANLI	250	mt.	4,436
001 155 015010 20 01	15X10 MM KABLO KANALI (SİDEM) YAPIŞKANLI	250	mt.	4,400
001 155 016016 20 01	16X16 MM KABLO KANALI (SİDEM) YAPIŞKANLI	230	mt.	5,107
001 155 020010 20 01	20X10 MM KABLO KANALI (SİDEM) YAPIŞKANLI	180	mt.	4,714
001 155 025016 20 01	25X16 MM KABLO KANALI (SİDEM) YAPIŞKANLI	150	mt.	6,237
001 155 025025 20 01	25X25 MM KABLO KANALI (SİDEM) YAPIŞKANLI	100	mt.	7,858
001 155 930010 20 01	30X10 MM KABLO KANALI (SİDEM) YAPIŞKANLI	140	mt.	5,415
001 155 930016 20 01	30X16 MM KABLO KANALI (SİDEM) YAPIŞKANLI	140	mt.	7,748
001 155 030025 20 01	30X25 MM KABLO KANALI (SİDEM) YAPIŞKANLI	80	mt.	8,323
001 155 040016 20 01	40X16 MM KABLO KANALI (SİDEM) YAPIŞKANLI	100	mt.	12,965
001 155 040025 20 01	40X25 MM KABLO KANALI (SİDEM) YAPIŞKANLI	80	mt.	11,068
001 155 040040 20 01	40X40 MM KABLO KANALI (SİDEM) YAPIŞKANLI	50	mt.	13,585
001 155 960025 20 01	60X25 MM KABLO KANALI (SİDEM) YAPIŞKANLI	40	mt.	16,576
001 155 060015 20 01	60X15 MM KABLO KANALI (SİDEM) YAPIŞKANLI	80	mt.	13,313
001 155 075018 20 01	75X18 MM KABLO KANALI (SİDEM) YAPIŞKANLI	60	mt.	20,074
001 155 060040 20 01	60X40 MM KABLO KANALI (SİDEM) YAPIŞKANLI	40	mt.	18,184

SİDEM SERİSİ SÜPÜRGELİKLER VE AKSESUARLARI

001 007 060015 20 01	60X15 MM KABLO KANALI (SİDEM)	40	mt.	11,521
001 031 060015 00 01	60X15 MM L KÖŞE(SİDEM)	1	ad.	5,442
001 032 060015 00 01	60X15 MM EK PARÇA (SİDEM)	1	ad.	2,553
001 033 060015 00 01	60X15 MM SONLAMA KAPAĞI (SİDEM)	1	ad.	2,648
001 030 060015 00 01	60X15 MM T KÖŞE (SİDEM)	1	ad.	6,222
001 007 075018 20 01	75X18 MM KABLO KANALI (SİDEM)	30	mt.	18,516
001 007 090020 20 01	90X20 MM KABLO KANALI (SİDEM)	20	mt.	26,212

12X12 KANAL AKSESUARLARI (SİDEM SERİSİ)

001 028 012012 00 01	12X12 MM (SİDEM) İÇ KÖŞE	1	ad.	1,570
001 029 012012 00 01	12X12 MM (SİDEM) DIŞ KÖŞE	1	ad.	1,607
001 030 012012 00 01	12X12 MM (SİDEM) T KÖŞE	1	ad.	1,605
001 031 012012 00 01	12X12 MM (SİDEM) 90 L KÖŞE	1	ad.	1,615
001 033 012012 00 01	12X12 MM (SİDEM) UÇ TAPA	1	ad.	1,566
001 032 012012 00 01	12X12 MM (SİDEM) EK PARÇASI	1	ad.	1,581

15X10 KANAL AKSESUARLARI (SİDEM SERİSİ)

001 028 015010 00 01	15X10 MM (SİDEM) İÇ KÖŞE	1	ad.	1,657
001 029 015010 00 01	15X10 MM (SİDEM) DIŞ KÖŞE	1	ad.	1,689
001 030 015010 00 01	15X10 MM (SİDEM) T KÖŞE	1	ad.	2,142
001 031 015010 00 01	15X10 MM (SİDEM) 90 L KÖŞE	1	ad.	1,962
001 033 015010 00 01	15X10 MM (SİDEM) UÇ TAPA	1	ad.	1,525
001 032 015010 00 01	15X10 MM (SİDEM) EK PARÇASI	1	ad.	1,817

16X16 KANAL AKSESUARLARI (SİDEM SERİSİ)







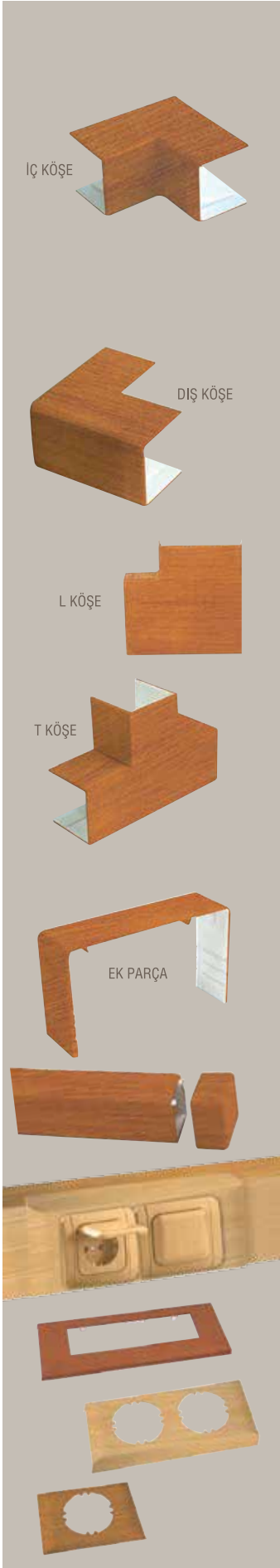











001 028 016016 00 01	16X16 MM (SİDEM) İÇ KÖŞE	1	ad.	1,917
001 029 016016 00 01	16X16 MM (SİDEM) DIŞ KÖŞE	1	ad.	1,641
001 030 016016 00 01	16X16 MM (SİDEM) T KÖŞE	1	ad.	2,578
001 031 016016 00 01	16X16 MM (SİDEM) 90 L KÖŞE	1	ad.	1,808
001 033 016016 00 01	16X16 MM (SİDEM) UÇ TAPA	1	ad.	1,572
001 032 016016 00 01	16X16 MM (SİDEM) EK PARÇASI	1	ad.	1,913

RENK SEÇENEKLERİ





Kod	Açıklama / Stok Cinsi	Amb. (Kutu)	Amb. Birimi	FİYAT
20X10 KANAL AKSESUARLARI (SİDEM SERİSİ)				
CE				
001 028 020010 00 01	20X10 MM (SİDEM) İÇ KÖŞE	1	ad.	1,723
001 029 020010 00 01	20X10 MM (SİDEM) DIŞ KÖŞE	1	ad.	1,707
001 030 020010 00 01	20X10 MM (SİDEM) T KÖŞE	1	ad.	1,583
001 031 020010 00 01	20X10 MM (SİDEM) 90 L KÖŞE	1	ad.	1,618
001 033 020010 00 01	20X10 MM (SİDEM) UÇ TAPA	1	ad.	1,575
001 032 020010 00 01	20X10 MM (SİDEM) EK PARÇASI	1	ad.	1,575
25X16 KANAL AKSESUARLARI (SİDEM SERİSİ)				
CE				
001 028 025016 00 01	25X16 MM (SİDEM) İÇ KÖŞE	1	ad.	2,980
001 029 025016 00 01	25X16 MM (SİDEM) DIŞ KÖŞE	1	ad.	2,442
001 030 025016 00 01	25X16 MM (SİDEM) T KÖŞE	1	ad.	2,944
001 031 025016 00 01	25X16 MM (SİDEM) 90 L KÖŞE	1	ad.	2,433
001 033 025016 00 01	25X16 MM (SİDEM) UÇ TAPA	1	ad.	2,277
001 032 025016 00 01	25X16 MM (SİDEM) EK PARÇA	1	ad.	2,356
001 034 017421 00 01	25X16 MM (SİDEM) PMK (45X45)	1	ad.	17,747
25X25 KANAL AKSESUARLARI (SİDEM SERİSİ)				
CE				
001 028 025025 00 01	25X25 MM (SİDEM) İÇ KÖŞE	1	ad.	3,168
001 029 025025 00 01	25X25 MM (SİDEM) DIŞ KÖŞE	1	ad.	3,213
001 030 025025 00 01	25X25 MM (SİDEM) T PARÇASI	1	ad.	3,258
001 031 025025 00 01	25X25 MM (SİDEM) 90 L KÖŞE	1	ad.	2,568
001 033 025025 00 01	25X25 MM (SİDEM) UÇ TAPA	1	ad.	2,451
001 032 025025 00 01	25X25 MM (SİDEM) EK PARÇA	1	ad.	2,340
001 034 017421 00 01	25X25 MM (SİDEM) PMK (45X45)	1	ad.	17,747
30X10 KANAL AKSESUARLARI (SİDEM SERİSİ)				
CE				
001 028 030010 00 01	30X10 MM (SİDEM) İÇ KÖŞE	1	ad.	3,174
001 029 030010 00 01	30X10 MM (SİDEM) DIŞ KÖŞE	1	ad.	3,450
001 030 030010 00 01	30X10 MM (SİDEM) T PARÇASI	1	ad.	3,231
001 031 030010 00 01	30X10 MM (SİDEM) 90 L KÖŞE	1	ad.	3,213
001 033 030010 00 01	30X10 MM (SİDEM) UÇ TAPA	1	ad.	3,213
001 032 030010 00 01	30X10 MM (SİDEM) EK PARÇA	1	ad.	3,010
30X16 KANAL AKSESUARLARI (SİDEM SERİSİ)				
CE				
001 028 030016 00 01	30X16 MM (SİDEM) İÇ KÖŞE	1	ad.	3,431
001 029 030016 00 01	30X16 MM (SİDEM) DIŞ KÖŞE	1	ad.	3,605
001 030 030016 00 01	30X16 MM (SİDEM) T PARÇASI	1	ad.	3,455
001 031 030016 00 01	30X16 MM (SİDEM) 90 L KÖŞE	1	ad.	3,402
001 033 030016 00 01	30X16 MM (SİDEM) UÇ TAPA	1	ad.	3,271
001 032 030016 00 01	30X16 MM (SİDEM) EK PARÇA	1	ad.	3,257
30X25 KANAL AKSESUARLARI (SİDEM SERİSİ)				
CE				
001 028 030025 00 01	30X25 MM (SİDEM) İÇ KÖŞE	1	ad.	3,793
001 029 030025 00 01	30X25 MM (SİDEM) DIŞ KÖŞE	1	ad.	4,054
001 030 030025 00 01	30X25 MM (SİDEM) T PARÇASI	1	ad.	3,490
001 031 030025 00 01	30X25 MM (SİDEM) 90 L KÖŞE	1	ad.	3,452
001 033 030025 00 01	30X25 MM (SİDEM) UÇ TAPA	1	ad.	3,302
001 032 030025 00 01	30X25 MM (SİDEM) EK PARÇA	1	ad.	3,280
40X16 KANAL AKSESUARLARI (SİDEM SERİSİ)				
CE				
001 028 040016 00 01	40X16 MM (SİDEM) İÇ KÖŞE	1	ad.	4,309
001 029 040016 00 01	40X16 MM (SİDEM) DIŞ KÖŞE	1	ad.	3,770
001 030 040016 00 01	40X16 MM (SİDEM) T KÖŞE	1	ad.	3,708
001 031 040016 00 01	40X16 MM (SİDEM) 90 L KÖŞE	1	ad.	3,641
001 033 040016 00 01	40X16 MM (SİDEM) UÇ TAPA	1	ad.	3,321
001 032 040016 00 01	40X16 MM (SİDEM) EK PARÇASI	1	ad.	3,454
001 034 017421 00 01	40X16 MM (SİDEM) PMK (45X45)	1	ad.	17,747
40X25 KANAL AKSESUARLARI (SİDEM SERİSİ)				
CE				
001 028 040025 00 01	40X25 MM (SİDEM) İÇ KÖŞE	1	ad.	3,831
001 029 040025 00 01	40X25 MM (SİDEM) DIŞ KÖŞE	1	ad.	4,211
001 030 040025 00 01	40X25 MM (SİDEM) T KÖŞE	1	ad.	3,896
001 031 040025 00 01	40X25 MM (SİDEM) 90 L KÖŞE	1	ad.	3,863
001 033 040025 00 01	40X25 MM (SİDEM) UÇ TAPA	1	ad.	3,611
001 032 040025 00 01	40X25 MM (SİDEM) EK PARÇASI	1	ad.	3,611
001 034 017421 00 01	40X25 MM (SİDEM) PMK (45X45)	1	ad.	17,747
40X40 KANAL AKSESUARLARI (SİDEM SERİSİ)				
CE				
001 028 040040 00 01	40X40 MM (SİDEM) İÇ KÖŞE	1	ad.	4,739
001 029 040040 00 01	40X40 MM (SİDEM) DIŞ KÖŞE	1	ad.	4,872
001 030 040040 00 01	40X40 MM (SİDEM) T PARÇASI	1	ad.	4,072
001 031 040040 00 01	40X40 MM (SİDEM) 90 L KÖŞE	1	ad.	4,090
001 033 040040 00 01	40X40 MM (SİDEM) UÇ TAPA	1	ad.	3,805
001 032 040040 00 01	40X40 MM (SİDEM) EK PARÇA	1	ad.	3,838
001 034 017421 00 01	40X40 MM (SİDEM) PMK (45X45)	1	ad.	17,747
75X22 KANAL AKSESUARLARI (SİDEM SERİSİ)				
CE				
001 028 075022 00 01	75X22 MM (SİDEM) İÇ KÖŞE	1	ad.	4,875
001 029 075022 00 01	75X22 MM (SİDEM) DIŞ KÖŞE	1	ad.	5,100
001 033 075022 01 01	75X22 MM (SİDEM) SAĞ SONLAMA	1	ad.	4,740
001 033 075022 02 01	75X22 MM (SİDEM) SOL SONLAMA	1	ad.	4,695
001 032 075022 00 01	75X22 MM (SİDEM) EK PARÇASI	1	ad.	4,860
60X25 KANAL AKSESUARLARI (SİDEM SERİSİ)				
CE				
001 028 060025 00 01	60X25 MM (SİDEM) İÇ KÖŞE	1	ad.	8,480
001 029 060025 00 01	60X25 MM (SİDEM) DIŞ KÖŞE	1	ad.	8,501
001 030 060025 00 01	60X25 MM (SİDEM) T PARÇASI	1	ad.	8,565
001 031 060025 00 01	60X25 MM (SİDEM) 90 L KÖŞE	1	ad.	8,601
001 033 060025 00 01	60X25 MM (SİDEM) UÇ TAPA	1	ad.	3,741
001 032 060025 00 01	60X25 MM (SİDEM) EK PARÇA	1	ad.	3,281
60X40 KANAL AKSESUARLARI (SİDEM SERİSİ)				
CE				
001 028 060040 00 01	60X40 MM (SİDEM) İÇ KÖŞE	1	ad.	8,417
001 029 060040 00 01	60X40 MM (SİDEM) DIŞ KÖŞE	1	ad.	8,472
001 030 060040 00 01	60X40 MM (SİDEM) T PARÇASI	1	ad.	8,484
001 031 060040 00 01	60X40 MM (SİDEM) 90 L KÖŞE	1	ad.	8,906
001 033 060040 00 01	60X40 MM (SİDEM) UÇ TAPA	1	ad.	4,040
001 032 060040 00 01	60X40 MM (SİDEM) EK PARÇA	1	ad.	3,618

Kod	Açıklama / Stok Cinsi	Amb. (Kutu)	Amb. Birimi	FİYAT
60X60 KANAL AKSESUARLARI (SİDEM SERİSİ)  				
001 028 060060 00 01	60X60 MM (SİDEM) İÇ KÖŞE	1	ad.	8,510
001 029 060060 00 01	60X60 MM (SİDEM) DIŞ KÖŞE	1	ad.	8,510
001 030 060060 00 01	60X60 MM (SİDEM) T PARÇASI	1	ad.	8,522
001 031 060060 00 01	60X60 MM (SİDEM) 90 L KÖŞE	1	ad.	8,548
001 033 060060 00 01	60X60 MM (SİDEM) UÇ TAPA	1	ad.	4,140
001 032 060060 00 01	60X60 MM (SİDEM) EK PARÇA	1	ad.	3,829
80X40 KANAL AKSESUARLARI (SİDEM SERİSİ)  				
001 028 080040 00 01	80X40 MM (SİDEM) İÇ KÖŞE	1	ad.	9,490
001 029 080040 00 01	80X40 MM (SİDEM) DIŞ KÖŞE	1	ad.	9,524
001 030 080040 00 01	80X40 MM (SİDEM) T PARÇASI	1	ad.	9,632
001 031 080040 00 01	80X40 MM (SİDEM) 90 L KÖŞE	1	ad.	9,603
001 033 080040 00 01	80X40 MM (SİDEM) UÇ TAPA	1	ad.	4,124
001 032 080040 00 01	80X40 MM (SİDEM) EK PARÇA	1	ad.	4,150
80X60 KANAL AKSESUARLARI (SİDEM SERİSİ)  				
001 028 080060 00 01	80X60 MM (SİDEM) İÇ KÖŞE	1	ad.	9,901
001 029 080060 00 01	80X60 MM (SİDEM) DIŞ KÖŞE	1	ad.	10,581
001 030 080060 00 01	80X60 MM (SİDEM) T PARÇASI	1	ad.	10,753
001 031 080060 00 01	80X60 MM (SİDEM) 90 L KÖŞE	1	ad.	10,830
001 033 080060 00 01	80X60 MM (SİDEM) UÇ TAPA	1	ad.	4,581
001 032 080060 00 01	80X60 MM (SİDEM) EK PARÇA	1	ad.	5,071
100X37 KANAL AKSESUARLARI (SİDEM SERİSİ)  				
001 028 100037 00 01	100X37 MM (SİDEM) İÇ KÖŞE (SABİT)	1	ad.	9,870
001 029 100037 00 01	100X37 MM (SİDEM) DIŞ KÖŞE (SABİT)	1	ad.	10,829
001 028 100037 01 01	100X37 MM (SİDEM) İÇ KÖŞE (HARKT)	1	ad.	10,214
001 029 100037 01 01	100X37 MM (SİDEM) DIŞ KÖŞE (HARKT)	1	ad.	11,020
001 030 100037 00 01	100X37 MM (SİDEM) T PARÇASI	1	ad.	10,049
001 031 100037 00 01	100X37 MM (SİDEM) 90 L KÖŞE	1	ad.	10,276
001 033 100037 00 01	100X37 MM (SİDEM) UÇ TAPA	1	ad.	4,617
001 032 100037 00 01	100X37 MM (SİDEM) EK PARÇA	1	ad.	4,189
100X36 KANAL AKSESUARLARI (SİDEM SERİSİ)  				
001 028 100036 00 01	100X36 MM (SİDEM) İÇ KÖŞE (SABİT)	1	ad.	9,898
001 029 100036 00 01	100X36 MM (SİDEM) DIŞ KÖŞE (SABİT)	1	ad.	9,992
001 028 100036 01 01	100X36 MM (SİDEM) İÇ KÖŞE (HARKT)	1	ad.	9,992
001 029 100036 01 01	100X36 MM (SİDEM) DIŞ KÖŞE (HARKT)	1	ad.	9,992
001 030 100036 00 01	100X36 MM (SİDEM) T PARÇASI	1	ad.	10,104
001 031 100036 00 01	100X36 MM (SİDEM) 90 L KÖŞE	1	ad.	11,000
001 033 100036 00 01	100X36 MM (SİDEM) UÇ TAPA	1	ad.	4,131
001 032 100036 00 01	100X36 MM (SİDEM) EK PARÇA	1	ad.	2,962
100X40 KANAL AKSESUARLARI (SİDEM SERİSİ)  				
001 028 100040 00 01	100X40 MM (SİDEM) İÇ KÖŞE (SABİT)	1	ad.	10,763
001 029 100040 00 01	100X40 MM (SİDEM) DIŞ KÖŞE (SABİT)	1	ad.	10,961
001 028 100040 01 01	100X40 MM (SİDEM) İÇ KÖŞE (HARKT)	1	ad.	10,763
001 029 100040 01 01	100X40 MM (SİDEM) DIŞ KÖŞE (HARKT)	1	ad.	10,961
001 030 100040 00 01	100X40 MM (SİDEM) T PARÇASI	1	ad.	11,064
001 031 100040 00 01	100X40 MM (SİDEM) 90 L KÖŞE	1	ad.	10,968
001 033 100040 00 01	100X40 MM (SİDEM) UÇ TAPA	1	ad.	4,131
001 032 100040 00 01	100X40 MM (SİDEM) EK PARÇA	1	ad.	2,962
100X48 KANAL AKSESUARLARI (SİDEM SERİSİ)  				
001 028 100048 00 01	100X48 MM (SİDEM) İÇ KÖŞE (SABİT)	1	ad.	11,828
001 029 100048 00 01	100X48 MM (SİDEM) DIŞ KÖŞE (SABİT)	1	ad.	11,071
001 028 100048 01 01	100X48 MM (SİDEM) İÇ KÖŞE (HARKT)	1	ad.	11,828
001 029 100048 01 01	100X48 MM (SİDEM) DIŞ KÖŞE (HARKT)	1	ad.	11,071
001 030 100048 00 01	100X48 MM (SİDEM) T PARÇASI	1	ad.	11,088
001 031 100048 00 01	100X48 MM (SİDEM) 90 L KÖŞE	1	ad.	11,059
001 033 100048 00 01	100X48 MM (SİDEM) UÇ TAPA	1	ad.	4,530
001 032 100048 00 01	100X48 MM (SİDEM) EK PARÇA	1	ad.	3,239
100X50 KANAL AKSESUARLARI (SİDEM SERİSİ)  				
001 028 100050 00 01	100X50 MM (SİDEM) İÇ KÖŞE (SABİT)	1	ad.	11,487
001 029 100050 00 01	100X50 MM (SİDEM) DIŞ KÖŞE (SABİT)	1	ad.	11,137
001 028 100050 01 01	100X50 MM (SİDEM) İÇ KÖŞE (HARKT)	1	ad.	11,329
001 029 100050 01 01	100X50 MM (SİDEM) DIŞ KÖŞE (HARKT)	1	ad.	12,221
001 030 100050 00 01	100X50 MM (SİDEM) T PARÇASI	1	ad.	11,438
001 031 100050 00 01	100X50 MM (SİDEM) 90 L KÖŞE	1	ad.	11,368
001 033 100050 00 01	100X50 MM (SİDEM) UÇ TAPA	1	ad.	5,533
001 032 100050 00 01	100X50 MM (SİDEM) EK PARÇA	1	ad.	5,201
100X60 KANAL AKSESUARLARI (SİDEM SERİSİ)  				
001 028 100060 00 01	100X60 MM (SİDEM) İÇ KÖŞE (SABİT)	1	ad.	11,494
001 029 100060 00 01	100X60 MM (SİDEM) DIŞ KÖŞE (SABİT)	1	ad.	12,203
001 028 100060 01 01	100X60 MM (SİDEM) İÇ KÖŞE (HARKT)	1	ad.	11,494
001 029 100060 01 01	100X60 MM (SİDEM) DIŞ KÖŞE (HARKT)	1	ad.	12,203
001 030 100060 00 01	100X60 MM (SİDEM) T PARÇASI	1	ad.	11,884
001 031 100060 00 01	100X60 MM (SİDEM) 90 L KÖŞE	1	ad.	10,604
001 033 100060 00 01	100X60 MM (SİDEM) UÇ TAPA	1	ad.	4,788
001 032 100060 00 01	100X60 MM (SİDEM) EK PARÇA	1	ad.	3,351
İÇTEN KAPAKLI 100X37/50 İÇİN PMS (SİDEM SERİSİ)				
001 034 400001 00 01	100X37/50 (SİDEM) 45X45 PMS TEKLİ	1	ad.	7,744
001 034 400002 00 01	100X37/50 (SİDEM) 45X45 PMS İKİLİ	1	ad.	9,192
001 034 400003 00 01	100X37/50 (SİDEM) 45X45 PMS ÜÇLÜ	1	ad.	12,007
001 034 400004 00 01	100X37/50 (SİDEM) 45X45 PMS DÖRTLÜ	1	ad.	12,398
001 034 500001 00 01	100X37/50 (SİDEM) 55X55 PMS TEKLİ	1	ad.	8,469
001 034 500002 00 01	100X37/50 (SİDEM) 55X55 PMS İKİLİ	1	ad.	10,476
001 034 500003 00 01	100X37/50 (SİDEM) 55X55 PMS ÜÇLÜ	1	ad.	13,297
DIŞTAN KAPAKLI 100'LÜK PMS (55X55 İÇİN) (SİDEM SERİSİ)				
001 034 000001 00 01	100'LÜK 55X55 PMS TEKLİ SİDEM	1	ad.	8,554
001 034 000002 00 01	100'LÜK 55X55 PMS İKİLİ SİDEM	1	ad.	12,102
001 034 000003 00 01	100'LÜK 55X55 PMS ÜÇLÜ SİDEM	1	ad.	15,345
DIŞTAN KAPAKLI 100'LÜK SERİ PMS (45X45 İÇİN) (SİDEM SERİSİ)				
001 034 100001 00 01	100'LÜK 45X45 PMS TEKLİ SİDEM	1	ad.	8,610
001 034 100002 00 01	100'LÜK 45X45 PMS İKİLİ SİDEM	1	ad.	10,391
001 034 100003 00 01	100'LÜK 45X45 PMS ÜÇLÜ SİDEM	1	ad.	13,044
001 034 100004 00 01	100'LÜK 45X45 PMS DÖRTLÜ SİDEM	1	ad.	15,773

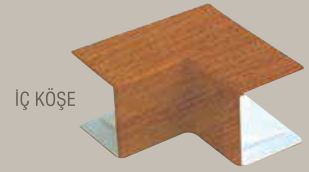

İÇ KÖŞE



DIŞ KÖŞE



L KÖŞE

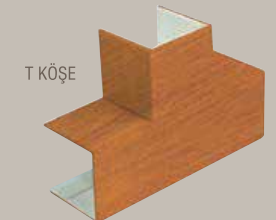

T KÖŞE



EK PARÇA



HAZIR KABLOLU SPİRALLER

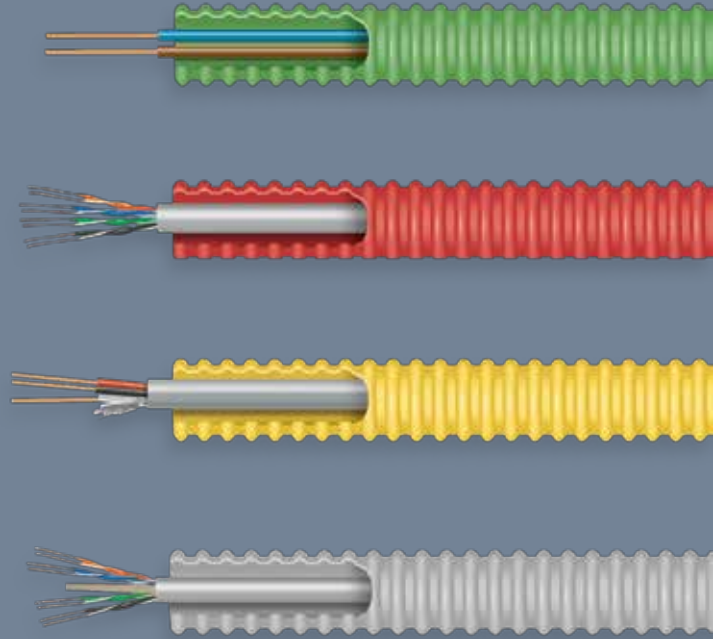

SPİRALLİ KABLOLAR

TÜM SPİRALLER HALOGEN FREE ÖZELLİKLİDİR.
HALOGEN FREE ÖZELLİĞİ KABLOLARDA
DEĞİŞMEKTEDİR.

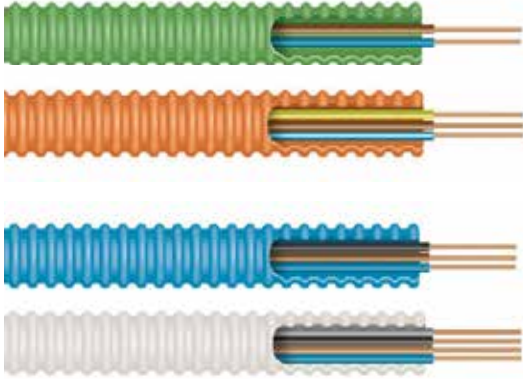

SPİRALLİ ENERJİ KABLOLARI HALOGEN FREE



Kod	Kablo Kesit mm ²	Spiral Özellik	Spiral Çap (mm)
H07Z1-U (NYA) KABLOLAR HALOGEN FREE			
122 051 215014	2x1.5	HF-PE	16
122 051 315014	3x1.5	HF-PE	16
122 051 415016	4x1.5	HF-PE	16
122 051 225014	2x2.5	HF-PE	16
122 051 325016	3x2.5	HF-PE	16
122 051 425020	4x2.5	HF-PE	20



SPİRALLİ ZAYIF AKIM KABLOLARI HALOGEN FREE



Kod	Kablo Kesit mm ²	Spiral Özellik	Spiral Çap (mm)
(LSZH) DATA KABLOLARI HALOGEN FREE			
122 053 100516	U/UTP CAT5e [4x2x24AWG]	HF-PE	14
122 053 100616	U/UTP CAT6 [4x2x23AWG]	HF-PE	14
(PHY - HF) KOAKSİYEL KABLOLAR HALOGEN FREE			
122 053 200416	RG 6 U/4 [Cu/AL]	HF-PE	14
122 053 200616	RG 6 U/6 [Cu/Cu]	HF-PE	14
CCTV KAMERA KABLOLARI HALOGEN FREE			
122 053 301214	1+2 RG 59 Mini [2x0.50 mm ²]	HF-PE	14
122 053 301416	1+4 RG 59 Mini [2x0.50 mm ²] + [2x0.22 mm ²]	HF-PE	14
J-H (st) H YANGIN İHBAR KABLOSU HALOGEN FREE			
122 053 401216	1x2x0,80 mm ² + 0,80 mm ²	HF-PE	14
122 053 402216	2x2x0,80 mm ² + 0,80 mm ²	HF-PE	14
LIHH DİYAFON KABLOLARI HALOGEN FREE			
122 053 502216	LIHH 8x0.22 mm ²	HF-PE	14

*Güncel fiyatlar için satış temsilciniz ile irtibata geçiniz.

SPİRALLİ KABLolar

TÜM SPİRALLER HALOGEN FREE ÖZELLİKLİDİR.
HALOGEN FREE ÖZELLİĞİ KABLolarDA
DEĞİŞMEKTEDİR.

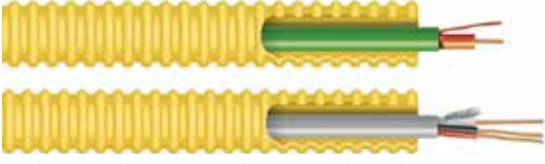
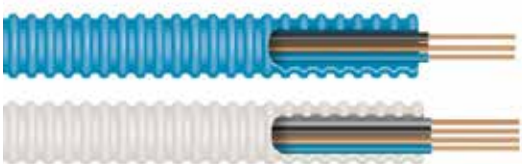
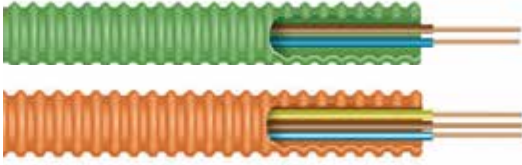

SPİRALLİ ENERJİ KABLolarI

Kod	Kablo Kesit mm ²	Spiral Özellik	Spiral Çap (mm)
H07V-U (NYA) KABLolar			
122 050 215014	2x1.5	HF-PE	16
122 050 315014	3x1.5	HF-PE	16
122 050 415016	4x1.5	HF-PE	16
122 050 225014	2x2.5	HF-PE	16
122 050 325016	3x2.5	HF-PE	16
122 050 425020	4x2.5	HF-PE	20

SPİRALLİ ZAYIF AKIM KABLolarI

Kod	Kablo Kesit mm ²	Spiral Özellik	Spiral Çap (mm)
DATA KABLolarI			
122 052 100516	U / UTP CAT5e	HF-PE	14
122 052 100616	U / UTP CAT6e	HF-PE	14

KOAKSİYEL KABLolar

122 052 200214	RG 59/U2(cu/AL)	HF-PE	14
122 052 200416	RG 6/U4 (cu/AL)	HF-PE	14
122 052 200616	RG 6/U6 (cu/cu)	HF-PE	14

CCTV KAMERA KABLolarI

122 052 301214	CCTV 1+2 (2x0.22 mm ²)	HF-PE	14
122 052 301416	CCTV 1+4 (2x2x0.22 mm ²)	HF-PE	14

JY (st) Y YANGIN İHBAR KABLolarI

122 052 401215	JY(st)Y 1x2x0.80+40 mm ²	HF-PE	14
122 052 402216	JY(st)Y 2x2x0.80+40 mm ²	HF-PE	14

DİYAFON KABLolarI

122 052 502216	DT-8 8x0.22 mm ²	HF-PE	14
----------------	-----------------------------	-------	----

*Güncel fiyatlar için satış temsilciniz ile irtibata geçiniz.

Kod	Açıklama / Stok Cinsi			Amb. (Kutu)	Amb. Birimi	FİYAT
MEKS SERİSİ PLASTİK SİRALLER (SİYAH)						
		İç Çap	Dış Çap			
001 020 400014 00 11	14 Ø PLASTİK SİRALLER (SİYAH)	15,25	18,75	100 mt.	1000	0,455
001 020 400016 00 11	16 Ø PLASTİK SİRALLER (SİYAH)	15,7	19	100 mt.	1000	0,495
001 020 400018 00 11	18 Ø PLASTİK SİRALLER (SİYAH)	19,6	24,03	50 mt.	500	0,682
001 020 400020 00 11	20 Ø PLASTİK SİRALLER (SİYAH)	19,6	24,03	50 mt.	500	0,682
001 020 400026 00 11	26 Ø PLASTİK SİRALLER (SİYAH)	26,15	30,75	50 mt.	250	0,870
001 020 400032 00 11	32 Ø PLASTİK SİRALLER (SİYAH)	29,1	34,3	50 mt.	250	1,199
001 020 400040 00 11	40 Ø PLASTİK SİRALLER (SİYAH)	36,2	42,2	25 mt.	125	1,693
001 020 400050 00 11	50 Ø PLASTİK SİRALLER (SİYAH)	48,5	54,5	25 mt.	125	2,190

PLASTİK SİRALLER (SİYAH) (TELLİ)						
		İç Çap	Dış Çap			
001 020 410014 00 11	14 Ø PLASTİK SİRALLER (SİYAH) TELLİ	15,25	18,75	100 mt.	1000	0,597
001 020 410016 00 11	16 Ø PLASTİK SİRALLER (SİYAH) TELLİ	15,7	19	100 mt.	1000	0,680
001 020 410018 00 11	18 Ø PLASTİK SİRALLER (SİYAH) TELLİ	19,6	24,03	50 mt.	500	0,805
001 020 410020 00 11	20 Ø PLASTİK SİRALLER (SİYAH) TELLİ	19,6	24,03	50 mt.	500	0,805
001 020 410026 00 11	26 Ø PLASTİK SİRALLER (SİYAH) TELLİ	26,15	30,75	50 mt.	250	1,048
001 020 410032 00 11	32 Ø PLASTİK SİRALLER (SİYAH) TELLİ	29,1	34,3	50 mt.	250	1,283
001 020 410040 00 11	40 Ø PLASTİK SİRALLER (SİYAH) TELLİ	36,2	42,2	25 mt.	125	1,762

PLASTİK SİRALLER (RENKLİ)						
		İç Çap	Dış Çap			
001 020 400014 00 17	14 Ø PLS. SİRAL (GRI-BYZ-KIR-MAVI)	15,25	18,75	100 mt.	1000	0,655
001 020 400016 00 17	16 Ø PLS. SİRAL (GRI-BYZ-KIR-MAVI)	15,7	19	100 mt.	1000	0,788
001 020 400018 00 17	18 Ø PLS. SİRAL (GRI-BYZ-KIR-MAVI)	19,6	24,03	50 mt.	500	1,007
001 020 400020 00 17	20 Ø PLS. SİRAL (GRI-BYZ-KIR-MAVI)	19,6	24,03	50 mt.	250	1,007
001 020 400026 00 17	26 Ø PLS. SİRAL (GRI-BYZ-KIR-MAVI)	26,15	30,75	50 mt.	250	1,297
001 020 400032 00 17	32 Ø PLS. SİRAL (GRI-BYZ-KIR-MAVI)	29,1	34,3	50 mt.	250	2,147
001 020 400040 00 17	40 Ø PLS. SİRAL (GRI-BYZ-KIR-MAVI)	36,2	42,2	25 mt.	125	2,230
001 020 400050 00 17	50 Ø PLS. SİRAL (GRI-BYZ-KIR-MAVI)	48,5	54,5	25 mt.	125	3,491
001 020 990016 00 17	16MM SİRAL EK MUFU (GRI)			200 ad.		0,309
001 020 990020 00 17	20MM SİRAL EK MUFU (GRI)			200 ad.		0,435
001 020 990025 00 17	25MM SİRAL EK MUFU (GRI)			100 ad.		0,558
001 020 990032 00 17	32MM SİRAL EK MUFU (GRI)			200 ad.		0,628

PP POLYPROPİLEN SİRALLER							
		Rekor Ölçüleri	İç Çap	Dış Çap			
001 020 160007 00 11	MUT/PP-7 PP SİRAL BORU		7	10,1	100 mt.	1000	0,472
001 020 160009 00 11	MUT/PP-8,5 PP SİRAL BORU	PSR7	5,4	12,05	100 mt.	1000	0,590
001 020 160010 00 11	MUT/PP-10 PP SİRAL BORU	PSR9	10,2	13,1	100 mt.	1000	0,636
001 020 160012 00 11	MUT/PP-12 PP SİRAL BORU	PSR11	12,3	15,9	50 mt.	500	0,797
001 020 160014 00 11	MUT/PP-14 PP SİRAL BORU	PSR13,5	14,1	18,35	50 mt.	250	1,063
001 020 160017 00 11	MUT/PP-17 PP SİRAL BORU	PSR16	17	21,45	50 mt.	250	1,328
001 020 160019 00 11	MUT/PP-19 PP SİRAL BORU		19	24,25	50 mt.	250	1,594
001 020 160023 00 11	MUT/PP-23 PP SİRAL BORU	PSR21	23,25	28,5	50 mt.	250	1,628
001 020 160026 00 11	MUT/PP-26 PP SİRAL BORU		26,2	31,3	25 mt.	125	1,860
001 020 160029 00 11	MUT/PP-29 PP SİRAL BORU	PSR29	29,1	34,3	25 mt.	125	2,125
001 020 160036 00 11	MUT/PP-36 PP SİRAL BORU	PSR36	35,8	42,2	25 mt.	125	2,923
001 020 160048 00 11	MUT/PP-48 PP SİRAL BORU	PSR48	48,5	54,5	25 mt.	125	4,252













PA6 POLYAMİD SİRALLER (A. YAYMAYAN)							
		Rekor Ölçüleri	İç Çap	Dış Çap			
001 020 170007 00 11	MUT/PA6-7 (A. YAYMAYAN)		7	10,1	100 mt.	1000	1,186
001 020 170009 00 11	MUT/PA6-8,5 (A. YAYMAYAN)	PSR7	8,4	12,05	100 mt.	1000	1,317
001 020 170010 00 11	MUT/PA6-10 (A. YAYMAYAN)	PSR9	10,2	13,1	100 mt.	1000	1,449
001 020 170012 00 11	MUT/PA6-12 (A. YAYMAYAN)	PSR11	12,3	15,9	50 mt.	500	2,305
001 020 170014 00 11	MUT/PA6-14 (A. YAYMAYAN)	PSR13,5	14,1	18,35	50 mt.	250	2,898
001 020 170017 00 11	MUT/PA6-17 (A. YAYMAYAN)	PSR16	17	21,45	50 mt.	250	3,557
001 020 170019 00 11	MUT/PA6-19 (A. YAYMAYAN)		19	24,25	50 mt.	250	4,479
001 020 170023 00 11	MUT/PA6-23 (A. YAYMAYAN)	PSR21	23,25	28,5	50 mt.	250	4,940
001 020 170026 00 11	MUT/PA6-26 (A. YAYMAYAN)		26,2	31,3	25 mt.	125	5,269
001 020 170029 00 11	MUT/PA6-29 (A. YAYMAYAN)	PSR29	29,1	34,3	25 mt.	125	6,257
001 020 170036 00 11	MUT/PA6-36 (A. YAYMAYAN)	PSR36	36,2	42,2	25 mt.	125	10,538
001 020 170048 00 11	MUT/PA6-48 (A. YAYMAYAN)	PSR48	48,5	54,5	25 mt.	125	12,251



























































POLYAMİD SİRAL RAKORU						
057 097 110007	PSR-7 SİRAL RAKORU				50 ad.	0,491 €
057 097 110009	PSR-9 SİRAL RAKORU				50 ad.	0,524 €
057 097 110011	PSR-11 SİRAL RAKORU				50 ad.	0,557 €
057 097 110135	PSR-13,5 SİRAL RAKORU				50 ad.	0,590 €
057 097 110016	PSR-16 SİRAL RAKORU				25 ad.	0,688 €
057 097 110021	PSR-21 SİRAL RAKORU				20 ad.	1,080 €
057 097 110029	PSR-29 SİRAL RAKORU				10 ad.	1,867 €
057 097 110036	PSR-36 SİRAL RAKORU				1 ad.	2,652 €
057 097 110048	PSR-48 SİRAL RAKORU				1 ad.	3,438 €

POLYAMİD SİRAL DİRSEĞİ						
057 097 120007	PSRD-7 SİRAL RAKORU 90° DİRSEK				1 ad.	0,916 €
057 097 120009	PSRD-9 SİRAL RAKORU 90° DİRSEK				1 ad.	0,982 €
057 097 120011	PSRD-11 SİRAL RAKORU 90° DİRSEK				1 ad.	1,080 €
057 097 120135	PSRD-13,5 SİRAL RAKORU 90° DİRSEK				1 ad.	1,277 €
057 097 120016	PSRD-16 SİRAL RAKORU 90° DİRSEK				1 ad.	1,473 €
057 097 120021	PSRD-21 SİRAL RAKORU 90° DİRSEK				1 ad.	2,357 €
057 097 120029	PSRD-29 SİRAL RAKORU 90° DİRSEK				1 ad.	3,045 €
057 097 120036	PSRD-36 SİRAL RAKORU 90° DİRSEK				1 ad.	4,125 €





Kod	Açıklama / Stok Cinsi	İç Çap	Dış Çap	Amb. (Kutu)	Amb. Birimi	FİYAT
HAFİF SERİ PVC. SİRALLER (ALEV YAYMAYAN) (320N) 						
001 020 010016 00 17	16 Ø A.YAYMAYAN SİRAL (HAFİF SERİ)	11,2	15,85	100 mt.	500	0,732
001 020 010020 00 17	20 Ø A.YAYMAYAN SİRAL (HAFİF SERİ)	14,4	19,85	100 mt.	500	1,068
001 020 010025 00 17	25 Ø A.YAYMAYAN SİRAL (HAFİF SERİ)	18,1	24,8	50 mt.	250	1,430
001 020 010032 00 17	32 Ø A.YAYMAYAN SİRAL (HAFİF SERİ)	25,9	31,8	50 mt.	250	1,839
AĞIR SERİ PVC. SİRALLER (ALEV YAYMAYAN) (750N) 						
001 020 000016 00 17	16 Ø A.YAYMAYAN SİRAL (AĞIR SERİ)	11,2	15,85	100 mt.	500	0,770
001 020 000020 00 17	20 Ø A.YAYMAYAN SİRAL (AĞIR SERİ)	14,4	19,85	100 mt.	500	1,139
001 020 000025 00 17	25 Ø A.YAYMAYAN SİRAL (AĞIR SERİ)	18,1	24,8	50 mt.	250	1,527
001 020 000032 00 17	32 Ø A.YAYMAYAN SİRAL (AĞIR SERİ)	25,9	31,8	50 mt.	250	2,032
HAFİF SERİ PVC. TELLİ SİRALLER (A.YAYMAYAN) (320N) 						
001 020 120016 00 17	16 Ø TELLİ A.YAYMAYAN (HAFİF SERİ)	11,2	15,85	100 mt.	500	0,845
001 020 120020 00 17	20 Ø TELLİ A.YAYMAYAN (HAFİF SERİ)	14,4	19,85	100 mt.	500	1,117
001 020 120025 00 17	25 Ø TELLİ A.YAYMAYAN (HAFİF SERİ)	18,1	24,8	50 mt.	250	1,506
001 020 120032 00 17	32 Ø TELLİ A.YAYMAYAN (HAFİF SERİ)	25,9	31,8	50 mt.	250	1,992
AĞIR SERİ PVC. TELLİ SİRALLER (A.YAYMAYAN) (750N) 						
001 020 100016 00 17	16 Ø TELLİ A.YAYMAYAN (AĞIR SERİ)	11,2	15,85	100 mt.	500	0,886
001 020 100020 00 17	20 Ø TELLİ A.YAYMAYAN (AĞIR SERİ)	14,4	19,85	100 mt.	500	1,293
001 020 100025 00 17	25 Ø TELLİ A.YAYMAYAN (AĞIR SERİ)	18,1	24,8	50 mt.	250	1,700
001 020 100032 00 17	32 Ø TELLİ A.YAYMAYAN (AĞIR SERİ)	25,9	31,8	50 mt.	250	2,209
HALOJEN FREE SİRALLER (A.YAYAN) (320N) 						
001 020 140016 00 17	16 Ø HALOJEN FREE SPR. (ALEV YAYAN)	11,15	15,7	100 mt.	500	0,658
001 020 140020 00 17	20 Ø HALOJEN FREE SPR. (ALEV YAYAN)	14,4	19,85	100 mt.	500	0,773
001 020 140025 00 17	25 Ø HALOJEN FREE SPR. (ALEV YAYAN)	19,5	24,7	50 mt.	250	1,106
001 020 140032 00 17	32 Ø HALOJEN FREE SPR. (ALEV YAYAN)	24,85	30,9	50 mt.	250	1,422
001 020 140040 00 17	40 Ø HALOJEN FREE SPR. (ALEV YAYAN)			25 mt.	125	2,210
001 020 140050 00 17	50 Ø HALOJEN FREE SPR. (ALEV YAYAN)			25 mt.	125	2,785
HALOJEN FREE SİRALLER (A.YAYAN) (750N) 						
001 020 740020 00 17	20 Ø HALOJEN FREE SPR. (ALEV YAYAN)	11,15	15,7	100 mt.	500	1,643
001 020 740025 00 17	25 Ø HALOJEN FREE SPR. (ALEV YAYAN)	14,4	19,85	50 mt.	250	2,188
001 020 740032 00 17	32 Ø HALOJEN FREE SPR. (ALEV YAYAN)	19,5	24,7	50 mt.	250	2,951
HALOJEN FREE SİRALLER (A.YAYAN) (1250N) 						
001 020 240020 00 17	20 Ø HALOJEN FREE SPR. (ALEV YAYAN)	11,15	15,7	100 mt.	500	2,188
001 020 240025 00 17	25 Ø HALOJEN FREE SPR. (ALEV YAYAN)	14,4	19,85	50 mt.	250	3,104
001 020 240032 00 17	32 Ø HALOJEN FREE SPR. (ALEV YAYAN)	19,5	24,7	50 mt.	250	3,932
HALOJEN FREE SİRALLER TELLİ (A.YAYAN) (320N) 						
001 020 141016 00 17	16 Ø H.FREE SİRAL(A.YAYAN)(TELLİ)	11,15	15,7	100 mt.	500	0,778
001 020 141020 00 17	20 Ø H.FREE SİRAL(A.YAYAN)(TELLİ)	14,4	19,85	100 mt.	500	0,977
001 020 141025 00 17	25 Ø H.FREE SİRAL(A.YAYAN)(TELLİ)	19,5	24,7	50 mt.	250	1,308
001 020 141032 00 17	32 Ø H.FREE SİRAL(A.YAYAN)(TELLİ)	24,85	31,6	50 mt.	250	1,529
001 020 141040 00 17	40 Ø H.FREE SİRAL(A.YAYAN)(TELLİ)			25 mt.	125	2,413
HALOJEN FREE SİRALLER (A.YAYMAYAN) (320N) 						
001 020 150016 00 17	16 Ø HALOJEN FREE SPR.(A.YAYMAYAN)	11,15	15,7	100 mt.	500	0,949
001 020 150020 00 17	20 Ø HALOJEN FREE SPR.(A.YAYMAYAN)	14,4	19,85	100 mt.	500	1,054
001 020 150025 00 17	25 Ø HALOJEN FREE SPR.(A.YAYMAYAN)	19,5	24,7	50 mt.	250	1,473
001 020 150032 00 17	32 Ø HALOJEN FREE SPR.(A.YAYMAYAN)	24,85	31,6	50 mt.	250	1,768
001 020 150040 00 17	40 Ø HALOJEN FREE SPR.(A.YAYMAYAN)			25 mt.	125	2,947
001 020 150050 00 17	50 Ø HALOJEN FREE SPR.(A.YAYMAYAN)			25 mt.	125	3,713
HALOJEN FREE SİRALLER (A.YAYMAYAN) (750N) 						
001 020 750020 00 17	20 Ø HALOJEN FREE SPR. (ALEV YAYMAYAN)	11,15	19,85	100 mt.	500	2,342
001 020 750025 00 17	25 Ø HALOJEN FREE SPR. (ALEV YAYMAYAN)	14,4	24,7	50 mt.	250	3,137
001 020 750032 00 17	32 Ø HALOJEN FREE SPR. (ALEV YAYMAYAN)	19,5	31,6	50 mt.	250	4,250
HALOJEN FREE SİRALLER (A.YAYMAYAN) (1250N) 						
001 020 250020 00 17	20 Ø HALOJEN FREE SPR. (ALEV YAYMAYAN)	11,15	19,85	100 mt.	500	3,137
001 020 250025 00 17	25 Ø HALOJEN FREE SPR. (ALEV YAYMAYAN)	14,4	24,7	50 mt.	250	4,473
001 020 250032 00 17	32 Ø HALOJEN FREE SPR. (ALEV YAYMAYAN)	19,5	31,6	50 mt.	250	5,681
HALOJEN FREE SİRALLER TELLİ (A.YAYMAYAN) (320N) 						
001 020 151016 00 17	16 Ø H.FREE SPR.(A.YAYMAYAN)(TELLİ)	11,15	15,7	100 mt.	500	1,064
001 020 151020 00 17	20 Ø H.FREE SPR.(A.YAYMAYAN)(TELLİ)	14,4	19,85	100 mt.	500	1,264
001 020 151025 00 17	25 Ø H.FREE SPR.(A.YAYMAYAN)(TELLİ)	19,5	24,7	50 mt.	250	1,706
001 020 151032 00 17	32 Ø H.FREE SPR.(A.YAYMAYAN)(TELLİ)	24,85	31,6	50 mt.	250	2,001
001 020 151040 00 17	40 Ø H.FREE SPR.(A.YAYMAYAN)(TELLİ)			25 mt.	125	3,179
KABLO TOPLAMA SİRALİ						
888 020 900003	R1034 16 MM KAB.TOP SPR.(1,5M VAK)			1 ad.	40	3,696 \$
888 020 900006	R1035 22 MM KAB.TOP SPR.(1,5M VAK)			1 ad.	40	5,029 \$
888 020 900009	R1036 28 MM KAB.TOP SPR.(1,5M VAK)			1 ad.	40	6,387 \$
888 020 900001	R1033 10 MM KAB.TOP SPR. (25M RULO)			1 mt.	50	1,832 \$
888 020 900004	R1034 16 MM KAB.TOP SPR. (25M RULO)			1 mt.	25	2,046 \$
888 020 900007	R1035 22 MM KAB.TOP SPR. (25M RULO)			1 mt.	25	2,855 \$
888 020 900010	R1036 28 MM KAB.TOP SPR. (25M RULO)			1 mt.	25	3,727 \$
888 020 900011	R1037 34 MM KAB.TOP SPR. (25M RULO)			1 mt.	25	4,665 \$
HELEZON PANO SİRALİ						
001 020 500001 05 00	NO.1 PANO SİRALİ (50CM)	5	6	100 ad.	4000	0,191
001 020 500002 05 00	NO.2 PANO SİRALİ (50CM)	7	8	100 ad.	3000	0,273
001 020 500003 05 00	NO.3 PANO SİRALİ (50CM)	10	11	100 ad.	2000	0,400
001 020 500004 05 00	NO.4 PANO SİRALİ (50CM)	13	14	50 ad.	800	0,872
001 020 500005 05 00	NO.5 PANO SİRALİ (50CM)	16	17	50 ad.	800	0,908
HELEZON PANO SİRALİ(RULO)						
001 020 600001 00 00	NO.1 PANO SİRALİ (100M)	5	6	100 mt.	500	0,381
001 020 600002 00 00	NO.2 PANO SİRALİ (100M)	7	8	100 mt.	500	0,545
001 020 600003 00 00	NO.3 PANO SİRALİ (100M)	10	11	100 mt.	500	0,799
001 020 600004 00 00	NO.4 PANO SİRALİ (100M)	13	14	50 mt.	250	1,744
001 020 600005 00 00	NO.5 PANO SİRALİ (100M)	16	17	50 mt.	250	1,817

Kod	Açıklama / Stok Cinsi	Amb. (Kutu)	Amb. Birimi	FİYAT
EKO SERİSİ ÇELİK SİRALLER  				
001 054 150009 00 66	9 Ø EKO ÇELİK SİRALLER	50 mt.	200	1,062
001 054 150011 00 66	11 Ø EKO ÇELİK SİRALLER (3/8")	50 mt.	200	1,241
001 054 150014 00 66	14 Ø EKO ÇELİK SİRALLER (1/2")	50 mt.	200	1,465
001 054 150016 00 66	16 Ø EKO ÇELİK SİRALLER	50 mt.	200	1,556
001 054 150018 00 66	18 Ø EKO ÇELİK SİRALLER (3/4")	50 mt.	200	1,720
001 054 150021 00 66	21 Ø EKO ÇELİK SİRALLER	50 mt.	200	2,133
001 054 150026 00 66	26 Ø EKO ÇELİK SİRALLER (1")	25 mt.	100	3,086
001 054 150029 00 66	29 Ø EKO ÇELİK SİRALLER (1 1/4")	25 mt.	100	3,569
001 054 150032 00 66	32 Ø EKO ÇELİK SİRALLER	25 mt.	100	3,696
001 054 150037 00 66	37 Ø EKO ÇELİK SİRALLER (1 1/2")	25 mt.	100	4,332
001 054 150042 00 66	42 Ø EKO ÇELİK SİRALLER	25 mt.	100	5,317
001 054 150050 00 66	50 Ø EKO ÇELİK SİRALLER (2")	25 mt.	100	5,824
EKO SERİSİ ÇELİK SİRALLER (KLAVUZ TELLİ)  				
001 054 221011 00 66	11 Ø EKO Ç. SİRALL(TELLİ)(3/8")	50 mt.	200	1,373
001 054 221014 00 66	14 Ø EKO Ç. SİRALL(TELLİ)(1/2")	50 mt.	200	1,606
001 054 221016 00 66	16 Ø EKO Ç. SİRALL (TELLİ)	50 mt.	200	1,794
001 054 221018 00 66	18 Ø EKO Ç. SİRALL(TELLİ) (3/4")	50 mt.	200	1,901
001 054 221021 00 66	21 Ø EKO Ç. SİRALL(TELLİ)	50 mt.	200	2,261
001 054 221026 00 66	26 Ø EKO Ç. SİRALL(TELLİ)(1")	25 mt.	100	3,158
001 054 221029 00 66	29 Ø EKO Ç. SİRALL(TELLİ)(1 1/4")	25 mt.	100	3,641
001 054 221032 00 66	32 Ø EKO Ç. SİRALL(TELLİ)	25 mt.	100	4,020
001 054 221037 00 66	37 Ø EKO Ç. SİRALL(TELLİ)(1 1/2")	25 mt.	100	4,718
001 054 221042 00 66	42 Ø EKO Ç. SİRALL(TELLİ)	25 mt.	100	5,801
001 054 221050 00 66	50 Ø EKO Ç. SİRALL(TELLİ) (2")	25 mt.	100	5,896
EKO SERİSİ İZOLELİ ÇELİK SİRALLER  				
001 054 160009 00 11	9 Ø EKO İZOLELİ Ç. SİRALL	50 mt.		1,518
001 054 160011 00 11	11 Ø EKO İZOLELİ Ç. SİRALL(3/8")	50 mt.		1,650
001 054 160014 00 11	14 Ø EKO İZOLELİ Ç. SİRALL(1/2")	50 mt.		1,925
001 054 160016 00 11	16 Ø EKO İZOLELİ Ç. SİRALL	50 mt.		2,063
001 054 160018 00 11	18 Ø EKO İZOLELİ Ç. SİRALL(3/4")	50 mt.		2,357
001 054 160021 00 11	21 Ø EKO İZOLELİ Ç. SİRALL	50 mt.		3,154
001 054 160026 00 11	26 Ø EKO İZOLELİ Ç. SİRALL(1")	25 mt.		3,781
001 054 160029 00 11	29 Ø EKO İZOLELİ Ç. SİRALL(1 1/4")	25 mt.		4,634
001 054 160032 00 11	32 Ø EKO İZOLELİ Ç. SİRALL	25 mt.		5,113
001 054 160037 00 11	37 Ø EKO İZOLELİ Ç. SİRALL (1 1/2")	25 mt.		5,443
001 054 160042 00 11	42 Ø EKO İZOLELİ Ç. SİRALL	25 mt.		7,103
001 054 160050 00 11	50 Ø EKO İZOLELİ Ç. SİRALL(2")	25 mt.		7,676
EKO SERİSİ İZOLELİ ÇELİK SİRALLER (KLAVUZ TELLİ)  				
001 054 231011 00 11	11 Ø EKO İZO.Ç. SPR.(TELLİ)(3/8")	50 mt.		1,828
001 054 231014 00 11	14 Ø EKO İZO.Ç. SPR.(TELLİ)(1/2")	50 mt.		2,010
001 054 231016 00 11	16 Ø EKO İZO.Ç. SPR. (TELLİ)	50 mt.		2,241
001 054 231018 00 11	18 Ø EKO İZO.Ç. SPR.(TELLİ) (3/4")	50 mt.		2,542
001 054 231021 00 11	21 Ø EKO İZO.Ç. SPR.(TELLİ)	50 mt.		3,112
001 054 231026 00 11	26 Ø EKO İZO.Ç. SPR.(TELLİ)(1")	25 mt.		3,891
001 054 231029 00 11	29 Ø EKO İZO.Ç. SPR.(TELLİ)(1 1/4")	25 mt.		4,709
001 054 231032 00 11	32 Ø EKO İZO.Ç. SPR.(TELLİ)	25 mt.		5,175
001 054 231037 00 11	37 Ø EKO İZO.Ç. SPR.(TELLİ)(1 1/2")	25 mt.		5,584
001 054 231042 00 11	42 Ø EKO İZO.Ç. SPR.(TELLİ)	25 mt.		7,410
001 054 231050 00 11	50 Ø EKO İZO.Ç. SPR.(TELLİ) (2")	25 mt.		8,294
MEKS SERİSİ ÇELİK SİRALLER				
001 054 120009 00 66	9 Ø ÇELİK SİRALLER	 	50 mt. 200	1,248
001 054 120011 00 66	11 Ø ÇELİK SİRALLER (3/8")	 	50 mt. 200	1,358
001 054 120014 00 66	14 Ø ÇELİK SİRALLER (1/2")	 	50 mt. 200	1,597
001 054 120016 00 66	16 Ø ÇELİK SİRALLER	 	50 mt. 200	1,746
001 054 120018 00 66	18 Ø ÇELİK SİRALLER (3/4")	 	50 mt. 200	1,888
001 054 120021 00 66	21 Ø ÇELİK SİRALLER	 	50 mt. 200	2,282
001 054 120026 00 66	26 Ø ÇELİK SİRALLER (1")	 	25 mt. 100	3,248
001 054 120029 00 66	29 Ø ÇELİK SİRALLER (1 1/4")	 	25 mt. 100	3,690
001 054 120032 00 66	32 Ø ÇELİK SİRALLER	 	25 mt. 100	4,212
001 054 120037 00 66	37 Ø ÇELİK SİRALLER (1 1/2")	 	25 mt. 100	4,804
001 054 120042 00 66	42 Ø ÇELİK SİRALLER	 	25 mt. 100	5,881
001 054 120050 00 66	50 Ø ÇELİK SİRALLER (2")	 	25 mt. 100	6,418
001 054 120063 00 66	63 Ø ÇELİK SİRALLER	 	15 mt. 60	8,386
MEKS SERİSİ ÇELİK SİRALLER (KLAVUZ TELLİ)				
001 054 121011 00 66	11 Ø Ç. SİRALL(TELLİ)(3/8")		50 mt. 200	1,603
001 054 121014 00 66	14 Ø Ç. SİRALL(TELLİ)(1/2")		50 mt. 200	1,812
001 054 121016 00 66	16 Ø Ç. SİRALL (TELLİ)		50 mt. 200	1,933
001 054 121018 00 66	18 Ø Ç. SİRALL(TELLİ) (3/4")		50 mt. 200	2,111
001 054 121021 00 66	21 Ø Ç. SİRALL(TELLİ)		50 mt. 200	2,310
001 054 121026 00 66	26 Ø Ç. SİRALL(TELLİ)(1")		25 mt. 100	3,248
001 054 121029 00 66	29 Ø Ç. SİRALL(TELLİ)(1 1/4")		25 mt. 100	3,965
001 054 121032 00 66	32 Ø Ç. SİRALL(TELLİ)		25 mt. 100	4,390
001 054 121037 00 66	37 Ø Ç. SİRALL(TELLİ)(1 1/2")		25 mt. 100	4,820
001 054 121042 00 66	42 Ø Ç. SİRALL(TELLİ)		25 mt. 100	5,846
001 054 121050 00 66	50 Ø Ç. SİRALL(TELLİ) (2")		25 mt. 100	6,026
001 054 121063 00 66	63 Ø Ç. SİRALL(TELLİ)		15 mt. 60	8,495
MEKS SERİSİ İZOLELİ ÇELİK SİRALLER				
001 054 130009 00 11	9 Ø İZOLELİ Ç. SİRALL	 	50 mt.	1,674
001 054 130011 00 11	11 Ø İZOLELİ Ç. SİRALL(3/8")	 	50 mt.	1,825
001 054 130014 00 11	14 Ø İZOLELİ Ç. SİRALL(1/2")	 	50 mt.	1,996
001 054 130016 00 11	16 Ø İZOLELİ Ç. SİRALL	 	50 mt.	2,221
001 054 130018 00 11	18 Ø İZOLELİ Ç. SİRALL(3/4")	 	50 mt.	2,498
001 054 130026 00 11	26 Ø İZOLELİ Ç. SİRALL(1")	 	25 mt.	4,119
001 054 130029 00 11	29 Ø İZOLELİ Ç. SİRALL(1 1/4")	 	25 mt.	4,651
001 054 130032 00 11	32 Ø İZOLELİ Ç. SİRALL	 	25 mt.	5,575
001 054 130037 00 11	37 Ø İZOLELİ Ç. SİRALL (1 1/2")	 	25 mt.	5,735
001 054 130042 00 11	42 Ø İZOLELİ Ç. SİRALL	 	25 mt.	7,219
001 054 130050 00 11	50 Ø İZOLELİ Ç. SİRALL(2")	 	25 mt.	8,310
001 054 130063 00 11	63 Ø İZOLELİ ÇELİK SİRALL	 	15 mt.	11,404

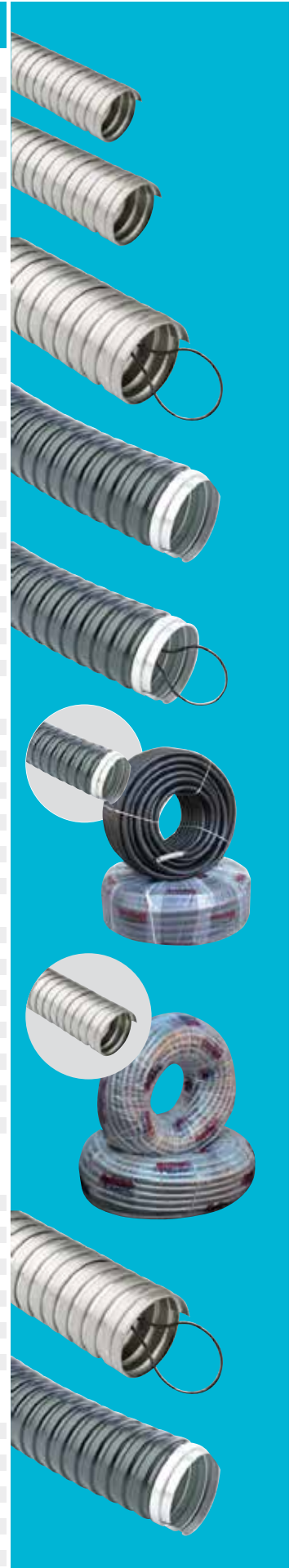



Kod	Açıklama / Stok Cinsi	Amb. (Kutu)	Amb. Birimi	FİYAT
-----	-----------------------	-------------	-------------	-------

MEKS SERİSİ İZOLELİ ÇELİK SİRALER (KLAVUZ TELLİ)

001 054 140011 00 11	11 Ø İZO.Ç. SPR.(TELLİ)(3/8")	50 mt.		2,054
001 054 140014 00 11	14 Ø İZO.Ç. SPR.(TELLİ)(1/2")	50 mt.		2,175
001 054 140016 00 11	16 Ø İZO.Ç. SPR. (TELLİ)	50 mt.		2,331
001 054 140018 00 11	18 Ø İZO.Ç. SPR.(TELLİ) (3/4")	50 mt.		2,682
001 054 140026 00 11	26 Ø İZO.Ç. SPR.(TELLİ)(1")	25 mt.		4,188
001 054 140029 00 11	29 Ø İZO.Ç. SPR.(TELLİ)(1 1/4")	25 mt.		4,853
001 054 140032 00 11	32 Ø İZO.Ç. SPR.(TELLİ)	25 mt.		5,700
001 054 140037 00 11	37 Ø İZO.Ç. SPR.(TELLİ)(1 1/2")	25 mt.		5,860
001 054 140042 00 11	42 Ø İZO.Ç. SPR.(TELLİ)	25 mt.		7,579
001 054 140050 00 11	50 Ø İZO.Ç. SPR.(TELLİ) (2")	25 mt.		8,403
001 054 140063 00 11	63 Ø İZO.Ç. SPR.(TELLİ)	15 mt.		11,721

NİKEL KAPLI ÇELİK SİRAL RAKORU

012 097 030009	CLK- 9 ÇELİK SİRAL RAKORU	150 ad.		7,662
012 097 030011	CLK-11 ÇELİK SİRAL RAKORU	175 ad.		9,822
012 097 030014	CLK-13,5 ÇELİK SİRAL RAKORU	90 ad.		10,804
012 097 030016	CLK-16 ÇELİK SİRAL RAKORU	75 ad.		12,605
012 097 030018	CLK-18 ÇELİK SİRAL RAKORU	80 ad.		14,733
012 097 030026	CLK-26 ÇELİK SİRAL RAKORU	30 ad.		19,972

SÜPER ETANJ PLASTİK RAKORLAR

010 097 000007	PG-7 PLASTİK RAKOR	450 ad.	4500	0,595
010 097 000009	PG-9 PLASTİK RAKOR	300 ad.	3000	0,685
010 097 000011	PG-11 PLASTİK RAKOR	200 ad.	2000	0,833
010 097 000135	PG-13,5 PLASTİK RAKOR	175 ad.	1750	0,923
010 097 000016	PG-16 PLASTİK RAKOR	125 ad.	1250	1,131
010 097 000021	PG-21 PLASTİK RAKOR	75 ad.	750	1,637
010 097 000029	PG-29 PLASTİK RAKOR	40 ad.	400	2,679
010 097 000036	PG-36 PLASTİK RAKOR	20 ad.	200	4,911
010 097 000042	PG-42 PLASTİK RAKOR	15 ad.	150	6,399
010 097 000048	PG-48 PLASTİK RAKOR	12 ad.	120	7,441

SÜPER ETANJ METAL RAKORLAR

057 097 100007	PG-7 METAL RAKOR	1 ad.		6,655
057 097 100009	PG-9 METAL RAKOR	1 ad.		6,655
057 097 100011	PG-11 METAL RAKOR	1 ad.		7,820
057 097 100135	PG-13,5 METAL RAKOR	1 ad.		9,317
057 097 100016	PG-16 METAL RAKOR	1 ad.		9,983
057 097 100021	PG-21 METAL RAKOR	1 ad.		15,473
057 097 100029	PG-29 METAL RAKOR	1 ad.		29,948
057 097 100036	PG-36 METAL RAKOR	1 ad.		61,559
057 097 100042	PG-42 METAL RAKOR	1 ad.		99,825
057 097 100048	PG-48 METAL RAKOR	1 ad.		116,463

PİRİNÇ RAKORLAR (NORMAL)

012 097 010009	9 Ø PİRİNÇ RAKOR (NORMAL)	1 ad.		5,402
012 097 010011	11 Ø PİRİNÇ RAKOR (NORMAL)	1 ad.		6,548
012 097 010135	13,5 Ø PİRİNÇ RAKOR (NORMAL)	1 ad.		8,185
012 097 010016	16 Ø PİRİNÇ RAKOR (NORMAL)	1 ad.		9,822
012 097 010021	21 Ø PİRİNÇ RAKOR (NORMAL)	1 ad.		14,733
012 097 010029	29 Ø PİRİNÇ RAKOR (NORMAL)	1 ad.		24,556
012 097 010036	36 Ø PİRİNÇ RAKOR (NORMAL)	1 ad.		34,378
012 097 010042	42 Ø PİRİNÇ RAKOR (NORMAL)	1 ad.		40,927









PİRİNÇ RAKORLAR (KELEPÇELİ)























012 097 020009	9 Ø PİRİNÇ RAKOR (KELEPÇELİ)	1 ad.		9,822
012 097 020011	11 Ø PİRİNÇ RAKOR (KELEPÇELİ)	1 ad.		11,460
012 097 020135	13,5 Ø PİRİNÇ RAKOR (KELEPÇELİ)	1 ad.		13,097
012 097 020016	16 Ø PİRİNÇ RAKOR (KELEPÇELİ)	1 ad.		14,733
012 097 020021	21 Ø PİRİNÇ RAKOR (KELEPÇELİ)	1 ad.		19,645
012 097 020029	29 Ø PİRİNÇ RAKOR (KELEPÇELİ)	1 ad.		32,742
012 097 020036	36 Ø PİRİNÇ RAKOR (KELEPÇELİ)	1 ad.		55,660
012 097 020042	42 Ø PİRİNÇ RAKOR (KELEPÇELİ)	1 ad.		75,305

Kod	Açıklama / Stok Cinsi	Amb. (Kutu)	Amb. Birimi	FİYAT
SİBOR SERİSİ H.FREE TURUNCU BORULAR (6 ATÜ) (A.YAYAN) (125N) HF				
001 165 706014 00 12	14/6 ATÜ BORU (H.FREE)(ALEV YAYAN) SİBOR	100	mt.	0,679
001 165 706016 00 12	16/6 ATÜ BORU (H.FREE)(ALEV YAYAN) SİBOR	100	mt.	0,835
001 165 706018 00 12	18/6 ATÜ BORU (H.FREE)(ALEV YAYAN) SİBOR	100	mt.	1,004
001 165 706020 00 12	20/6 ATÜ BORU (H.FREE)(ALEV YAYAN) SİBOR	100	mt.	1,121
001 165 706025 00 12	25/6 ATÜ BORU (H.FREE)(ALEV YAYAN) SİBOR	100	mt.	1,489
001 165 706032 00 12	32/6 ATÜ BORU (H.FREE)(ALEV YAYAN) SİBOR	100	mt.	2,374
001 165 706037 00 12	37/6 ATÜ BORU (H.FREE)(ALEV YAYAN) SİBOR	100	mt.	3,264
001 165 706040 00 12	40/6 ATÜ BORU (H.FREE)(ALEV YAYAN) SİBOR	100	mt.	3,785
001 165 706050 00 12	50/6 ATÜ BORU (H.FREE)(ALEV YAYAN) SİBOR	100	mt.	5,353
SİBOR SERİSİ H.FREE BORULAR (10 ATÜ) (A.YAYAN) (320N) HF				
001 165 710014 00 12	14/10 ATÜ BORU (H.FREE)(ALEV YAYAN) SİBOR	100	mt.	0,778
001 165 710016 00 12	16/10 ATÜ BORU (H.FREE)(ALEV YAYAN) SİBOR	100	mt.	0,916
001 165 710018 00 12	18/10 ATÜ BORU (H.FREE)(ALEV YAYAN) SİBOR	100	mt.	1,146
001 165 710020 00 12	20/10 ATÜ BORU (H.FREE)(ALEV YAYAN) SİBOR	100	mt.	1,368
001 165 710025 00 12	25/10 ATÜ BORU (H.FREE)(ALEV YAYAN) SİBOR	100	mt.	1,736
001 165 710032 00 12	32/10 ATÜ BORU (H.FREE)(ALEV YAYAN) SİBOR	100	mt.	2,779
001 165 710037 00 12	37/10 ATÜ BORU (H.FREE)(ALEV YAYAN) SİBOR	100	mt.	3,851
001 165 710040 00 12	40/10 ATÜ BORU (H.FREE)(ALEV YAYAN) SİBOR	100	mt.	4,979
001 165 710050 00 12	50/10 ATÜ BORU (H.FREE)(ALEV YAYAN) SİBOR	100	mt.	6,607
SİBOR SERİSİ H.FREE BORULAR (6 ATÜ) (A.YAYMAYAN)(125N) HF				
001 165 206014 00 12	14/6 ATÜ BORU (H.FREE)(ALEV YAYMAYAN) SİBOR	100	mt.	1,146
001 165 206016 00 12	16/6 ATÜ BORU (H.FREE)(ALEV YAYMAYAN) SİBOR	100	mt.	1,326
001 165 206018 00 12	18/6 ATÜ BORU (H.FREE)(ALEV YAYMAYAN) SİBOR	100	mt.	1,493
001 165 206020 00 12	20/6 ATÜ BORU (H.FREE)(ALEV YAYMAYAN) SİBOR	100	mt.	1,709
001 165 206025 00 12	25/6 ATÜ BORU (H.FREE)(ALEV YAYMAYAN) SİBOR	100	mt.	2,357
001 165 206032 00 12	32/6 ATÜ BORU (H.FREE)(ALEV YAYMAYAN) SİBOR	100	mt.	3,929
001 165 206037 00 12	37/6 ATÜ BORU (H.FREE)(ALEV YAYMAYAN) SİBOR	100	mt.	5,402
001 165 206040 00 12	40/6 ATÜ BORU (H.FREE)(ALEV YAYMAYAN) SİBOR	100	mt.	5,834
001 165 206050 00 12	50/6 ATÜ BORU (H.FREE)(ALEV YAYMAYAN) SİBOR	100	mt.	8,859
SİBOR SERİSİ H.FREE BORULAR (10 ATÜ) (A.YAYMAYAN)(320N) HF				
001 165 210014 00 12	14/10 ATÜ BORU (H.FREE)(ALEV YAYMAYAN) SİBOR	100	mt.	1,277
001 165 210016 00 12	16/10 ATÜ BORU (H.FREE)(ALEV YAYMAYAN) SİBOR	100	mt.	1,434
001 165 210018 00 12	18/10 ATÜ BORU (H.FREE)(ALEV YAYMAYAN) SİBOR	100	mt.	1,747
001 165 210020 00 12	20/10 ATÜ BORU (H.FREE)(ALEV YAYMAYAN) SİBOR	100	mt.	2,161
001 165 210025 00 12	25/10 ATÜ BORU (H.FREE)(ALEV YAYMAYAN) SİBOR	100	mt.	2,711
001 165 210032 00 12	32/10 ATÜ BORU (H.FREE)(ALEV YAYMAYAN) SİBOR	100	mt.	4,322
001 165 210037 00 12	37/10 ATÜ BORU (H.FREE)(ALEV YAYMAYAN) SİBOR	100	mt.	6,375
001 165 210040 00 12	40/10 ATÜ BORU (H.FREE)(ALEV YAYMAYAN) SİBOR	100	mt.	7,952
001 165 210050 00 12	50/10 ATÜ BORU (H.FREE)(ALEV YAYMAYAN) SİBOR	100	mt.	10,913
POLİETİLEN SİYAH YERALTI BORULAR (450N)				
001 165 406014 00 11	14/6 ATÜ POLİETİLEN BORU (SİYAH)	100	mt.	0,591
001 165 406016 00 11	16/6 ATÜ POLİETİLEN BORU (SİYAH)	100	mt.	0,728
001 165 406018 00 11	18/6 ATÜ POLİETİLEN BORU (SİYAH)	100	mt.	0,845
001 165 406020 00 11	20/6 ATÜ POLİETİLEN BORU (SİYAH)	100	mt.	1,004
001 165 406025 00 11	25/6 ATÜ POLİETİLEN BORU (SİYAH)	100	mt.	1,347
001 165 406032 00 11	32/6 ATÜ POLİETİLEN BORU (SİYAH)	100	mt.	2,111
001 165 406037 00 11	37/6 ATÜ POLİETİLEN BORU (SİYAH)	100	mt.	2,730
001 165 406040 00 11	40/6 ATÜ POLİETİLEN BORU (SİYAH)	100	mt.	3,006
001 165 406050 00 11	50/6 ATÜ POLİETİLEN BORU (SİYAH)	100	mt.	4,491
001 165 406063 00 11	63/6 ATÜ POLİETİLEN BORU (SİYAH)	100	mt.	6,951
001 165 406075 00 11	75/6 ATÜ POLİETİLEN BORU (SİYAH)	100	mt.	9,149
001 165 406090 00 11	90/6 ATÜ POLİETİLEN BORU (SİYAH)	75	mt.	12,784
POLİETİLEN SİYAH YER ALTI BORULAR (750N)				
001 165 410014 00 11	14/10 ATÜ POLİETİLEN BORU (SİYAH)	100	mt.	0,718
001 165 410016 00 11	16/10 ATÜ POLİETİLEN BORU (SİYAH)	100	mt.	0,842
001 165 410018 00 11	18/10 ATÜ POLİETİLEN BORU (SİYAH)	100	mt.	0,972
001 165 410020 00 11	20/10 ATÜ POLİETİLEN BORU (SİYAH)	100	mt.	1,185
001 165 410025 00 11	25/10 ATÜ POLİETİLEN BORU (SİYAH)	100	mt.	1,556
001 165 410032 00 11	32/10 ATÜ POLİETİLEN BORU (SİYAH)	100	mt.	2,245
001 165 410037 00 11	37/10 ATÜ POLİETİLEN BORU (SİYAH)	100	mt.	3,196
001 165 410040 00 11	40/10 ATÜ POLİETİLEN BORU (SİYAH)	100	mt.	3,760
001 165 410050 00 11	50/10 ATÜ POLİETİLEN BORU (SİYAH)	100	mt.	5,431
001 165 410063 00 11	63/10 ATÜ POLİETİLEN BORU (SİYAH)	100	mt.	7,865
001 165 410075 00 11	75/10 ATÜ POLİETİLEN BORU (SİYAH)	100	mt.	9,744
001 165 410090 00 11	90/10 ATÜ POLİETİLEN BORU (SİYAH)	75	mt.	15,523
001 165 410100 00 11	100/10 ATÜ POLİETİLEN BORU (SİYAH)	50	mt.	19,212
001 165 410110 00 11	110/10 ATÜ POLİETİLEN BORU (SİYAH)	50	mt.	21,957
POLİETİLEN SİYAH YER ALTI BORULAR (1250N)				
001 165 412020 00 11	20 Ø POLİETİLEN BORU (SİYAH)	100	mt.	1,635
001 165 412025 00 11	25 Ø POLİETİLEN BORU (SİYAH)	100	mt.	2,398
001 165 412032 00 11	32 Ø POLİETİLEN BORU (SİYAH)	100	mt.	3,270
HDPE KORUGE BORULAR				
096 045 150050	50 Ø KORUGE KANGAL BORU	100	mt.	4,316
096 045 150060	63 Ø KORUGE KANGAL BORU	100	mt.	4,911
096 045 150075	75 Ø KORUGE KANGAL BORU	100	mt.	5,655
096 045 150100	100 Ø KORUGE BOY BORU (6 MT.)	6	mt.	6,846
096 045 150115	115 Ø KORUGE BOY BORU (6 MT.)	6	mt.	7,292
096 045 150002	100 Ø MANŞON	1	ad.	2,866
096 045 150001	115 Ø MANŞON	1	ad.	3,163
HDPE KORUGE BORULAR				
096 045 160050	50 Ø KORUGE KANGAL BORU+MANŞON	6	mt.	4,865
096 045 160075	75 Ø KORUGE KANGAL BORU+MANŞON	6	mt.	5,650
096 045 150110	110 Ø KORUGE KANGAL BORU+MANŞON	6	mt.	7,470





Kod	Açıklama / Stok Cinsi	Amb. (Kutu)	Amb. Birimi	FİYAT
MEKS SERİSİ H.FREE TURUNCU BORULAR (6 ATÜ) (A.YAYAN) (320N) 				
001 165 506014 00 12	14/6 ATÜ BORU (H.FREE)(A.YAYAN)		100 mt.	0,720
001 165 506016 00 12	16/6 ATÜ BORU (H.FREE)(A.YAYAN)	☞ ☞	100 mt.	0,872
001 165 506018 00 12	18/6 ATÜ BORU (H.FREE)(A.YAYAN)		100 mt.	1,050
001 165 506020 00 12	20/6 ATÜ BORU (H.FREE)(A.YAYAN)	☞ ☞	100 mt.	1,179
001 165 506025 00 12	25/6 ATÜ BORU (H.FREE)(A.YAYAN)	☞ ☞	100 mt.	1,556
001 165 506032 00 12	32/6 ATÜ BORU (H.FREE)(A.YAYAN)	☞ ☞	100 mt.	2,429
001 165 506037 00 12	37/6 ATÜ BORU (H.FREE)(A.YAYAN)		100 mt.	3,412
001 165 506040 00 12	40/6 ATÜ BORU (H.FREE)(A.YAYAN)	☞ ☞	100 mt.	3,957
001 165 506050 00 12	50/6 ATÜ BORU (H.FREE)(A.YAYAN)	☞ ☞	100 mt.	5,542
001 165 506063 00 12	63/6 ATÜ BORU (H.FREE)(A.YAYAN)	☞ ☞	100 mt.	8,654
001 165 506075 00 12	75/6 ATÜ BORU (H.FREE)(A.YAYAN)	☞ ☞	100 mt.	10,921
001 165 506090 00 12	90/6 ATÜ BORU (H.FREE)(A.YAYAN)		75 mt.	16,498
MEKS SERİSİ H.FREE BORULAR (10 ATÜ) (A.YAYAN) (750N) 				
001 165 510014 00 12	14/10 ATÜ BORU (H.FREE)(A.YAYAN)		100 mt.	0,813
001 165 510016 00 12	16/10 ATÜ BORU (H.FREE)(A.YAYAN)	☞ ☞	100 mt.	0,968
001 165 510018 00 12	18/10 ATÜ BORU (H.FREE)(A.YAYAN)		100 mt.	1,198
001 165 510020 00 12	20/10 ATÜ BORU (H.FREE)(A.YAYAN)	☞ ☞	100 mt.	1,457
001 165 510025 00 12	25/10 ATÜ BORU (H.FREE)(A.YAYAN)	☞ ☞	100 mt.	1,815
001 165 510032 00 12	32/10 ATÜ BORU (H.FREE)(A.YAYAN)	☞ ☞	100 mt.	2,878
001 165 510037 00 12	37/10 ATÜ BORU (H.FREE)(A.YAYAN)		100 mt.	4,005
001 165 510040 00 12	40/10 ATÜ BORU (H.FREE)(A.YAYAN)	☞ ☞	100 mt.	5,205
001 165 510050 00 12	50/10 ATÜ BORU (H.FREE)(A.YAYAN)	☞ ☞	100 mt.	6,790
001 165 510063 00 12	63/10 ATÜ BORU (H.FREE)(A.YAYAN)	☞ ☞	100 mt.	9,836
001 165 510075 00 12	75/10 ATÜ BORU (H.FREE)(A.YAYAN)	☞ ☞	100 mt.	11,617
001 165 510090 00 12	90/10 ATÜ BORU (H.FREE)(A.YAYAN)		75 mt.	19,166
001 165 510100 00 12	100/10 ATÜ BORU (H.FREE)(A.YAYAN)		50 mt.	23,770
001 165 510110 00 12	110/10 ATÜ BORU (H.FREE)(A.YAYAN)		50 mt.	26,436
MEKS SERİSİ H.FREE BORULAR (A.YAYAN) (1250N) 				
001 165 512020 00 12	20 Ø BORU (H.FREE)(A.YAYAN)	☞ ☞	100 mt.	1,908
001 165 512025 00 12	25 Ø BORU (H.FREE)(A.YAYAN)	☞ ☞	100 mt.	2,798
001 165 512032 00 12	32 Ø BORU (H.FREE)(A.YAYAN)	☞ ☞	100 mt.	3,816
MEKS SERİSİ H.FREE BORULAR (6 ATÜ) (A.YAYMAYAN) (320N)  				
001 165 106014 00 12	14/6 ATÜ BORU (H.FREE)(A.YAYMAYAN)		100 mt.	1,198
001 165 106016 00 12	16/6 ATÜ BORU (H.FREE)(A.YAYMAYAN)	☞ ☞	100 mt.	1,397
001 165 106018 00 12	18/6 ATÜ BORU (H.FREE)(A.YAYMAYAN)		100 mt.	1,602
001 165 106020 00 12	20/6 ATÜ BORU (H.FREE)(A.YAYMAYAN)	☞ ☞	100 mt.	1,951
001 165 106025 00 12	25/6 ATÜ BORU (H.FREE)(A.YAYMAYAN)	☞ ☞	100 mt.	2,465
001 165 106032 00 12	32/6 ATÜ BORU (H.FREE)(A.YAYMAYAN)	☞ ☞	100 mt.	4,108
001 165 106037 00 12	37/6 ATÜ BORU (H.FREE)(A.YAYMAYAN)		100 mt.	5,647
001 165 106040 00 12	40/6 ATÜ BORU (H.FREE)(A.YAYMAYAN)	☞ ☞	100 mt.	6,326
001 165 106050 00 12	50/6 ATÜ BORU (H.FREE)(A.YAYMAYAN)	☞ ☞	100 mt.	9,714
001 165 106063 00 12	63/6 ATÜ BORU (H.FREE)(A.YAYMAYAN)	☞ ☞	100 mt.	14,298
001 165 106075 00 12	75/6 ATÜ BORU (H.FREE)(A.YAYMAYAN)	☞ ☞	100 mt.	19,203
001 165 106090 00 12	90/6 ATÜ BORU (H.FREE)(A.YAYMAYAN)		75 mt.	27,110
MEKS SERİSİ H.FREE BORULAR (10 ATÜ) (A.YAYMAYAN) (750N)  				
001 165 110014 00 12	14/10 ATÜ BORU (H.FREE)(A.YAYMAYAN)		100 mt.	1,335
001 165 110016 00 12	16/10 ATÜ BORU (H.FREE)(A.YAYMAYAN)	☞ ☞	100 mt.	1,602
001 165 110018 00 12	18/10 ATÜ BORU (H.FREE)(A.YAYMAYAN)		100 mt.	1,951
001 165 110020 00 12	20/10 ATÜ BORU (H.FREE)(A.YAYMAYAN)	☞ ☞	100 mt.	2,465
001 165 110025 00 12	25/10 ATÜ BORU (H.FREE)(A.YAYMAYAN)	☞ ☞	100 mt.	2,875
001 165 110032 00 12	32/10 ATÜ BORU (H.FREE)(A.YAYMAYAN)	☞ ☞	100 mt.	4,518
001 165 110037 00 12	37/10 ATÜ BORU (H.FREE)(A.YAYMAYAN)		100 mt.	6,777
001 165 110040 00 12	40/10 ATÜ BORU (H.FREE)(A.YAYMAYAN)	☞ ☞	100 mt.	8,133
001 165 110050 00 12	50/10 ATÜ BORU (H.FREE)(A.YAYMAYAN)	☞ ☞	100 mt.	11,748
001 165 110063 00 12	63/10 ATÜ BORU (H.FREE)(A.YAYMAYAN)	☞ ☞	100 mt.	17,095
001 165 110075 00 12	75/10 ATÜ BORU (H.FREE)(A.YAYMAYAN)	☞ ☞	100 mt.	21,759
001 165 110090 00 12	90/10 ATÜ BORU (H.FREE)(A.YAYMAYAN)		75 mt.	32,758
001 165 110100 00 12	100/10 ATÜ BORU (H.FREE)(A.YAYMAYAN)		50 mt.	41,034
001 165 110110 00 12	110/10 ATÜ BORU (H.FREE)(A.YAYMAYAN)		50 mt.	45,183
MEKS SERİSİ H.FREE BORULAR (A.YAYMAYAN) (1250N)  				
001 165 112020 00 12	20 Ø BORU (H.FREE)(A.YAYMAYAN)	☞ ☞	100 mt.	3,339
001 165 112025 00 12	25 Ø BORU (H.FREE)(A.YAYMAYAN)	☞ ☞	100 mt.	4,897
001 165 112032 00 12	32 Ø BORU (H.FREE)(A.YAYMAYAN)	☞ ☞	100 mt.	6,677
PLASTİK BORULAR				
001 045 000014 30 00	14 MM KALIN BOY BORU	102 mt.	510 mt.	0,578
001 045 000018 30 00	18 MM KALIN BOY BORU	102 mt.	510 mt.	0,776
001 045 000026 30 00	26 MM KALIN BOY BORU	51 mt.	255 mt.	1,411
001 045 000037 30 00	37 MM KALIN BOY BORU	30 mt.		2,696
001 045 010014 00 11	14 MM KANGAL (NORMAL)	100 mt.		0,574
001 045 010018 00 11	18 MM KANGAL (NORMAL)	100 mt.		0,776
001 045 010026 00 11	26 MM KANGAL (NORMAL)	50 mt.		1,406
001 045 010037 00 11	37 MM KANGAL (NORMAL)	50 mt.		3,082
001 045 020014 00 00	14 MM KANGAL (KAUÇUK)	100 mt.		0,567
001 045 020018 00 00	18 MM KANGAL (KAUÇUK)	100 mt.		0,786
001 045 020026 00 00	26 MM KANGAL (KAUÇUK)	50 mt.		1,406
001 045 020037 00 00	37 MM KANGAL (KAUÇUK)	50 mt.		2,967
001 045 030014 00 00	14 MM KANGAL (KAUÇUK) (KALIN)	100 mt.		0,702
001 045 030018 00 00	18 MM KANGAL (KAUÇUK) (KALIN)	100 mt.		0,974
PLASTİK DİRSEK VE MUFLAR				
127 051 000014	PLASTİK 14 Ø DİRSEK	100 ad.	2000	0,209
127 051 000018	PLASTİK 18 Ø DİRSEK	100 ad.	1000	0,248
127 051 000026	PLASTİK 26 Ø DİRSEK	100 ad.	500	0,337
001 051 020014 00 11	PLASTİK 14 Ø MUF		1500	0,209
001 051 020018 00 11	PLASTİK 18 Ø MUF		1000	0,283
001 051 020026 00 11	PLASTİK 26 Ø MUF		500	0,308
001 051 020037 00 11	PLASTİK 37 Ø MUF		250	0,410

Kod	Açıklama / Stok Cinsi	Amb. (Kutu)	Amb. Birimi	FİYAT
PVC. ALEV YAYMAYAN BOY BORULAR 				
001 045 120014 30 17	14 Ø PVC. ALEV YAYMAYAN BOY BORU (BOY: 3 MT)		102 mt.	1,298
001 045 120016 30 17	16 Ø PVC. ALEV YAYMAYAN BOY BORU (BOY: 3 MT)		102 mt.	1,331
001 045 120018 30 17	18 Ø PVC. ALEV YAYMAYAN BOY BORU (BOY: 3 MT)		102 mt.	1,778
001 045 120020 30 17	20 Ø PVC. ALEV YAYMAYAN BOY BORU (BOY: 3 MT)		102 mt.	2,118
001 045 120025 30 17	25 Ø PVC. ALEV YAYMAYAN BOY BORU (BOY: 3 MT)		51 mt.	2,879
001 045 120032 30 17	32 Ø PVC. ALEV YAYMAYAN BOY BORU (BOY: 3 MT)		30 mt.	4,412
001 045 120040 30 17	40 Ø PVC. ALEV YAYMAYAN BOY BORU (BOY: 3 MT)		30 mt.	7,996
PVC. ALEV YAYMAYAN KENDİNDEN MUFLU BOY BORULAR 				
001 045 110014 30 17	14 Ø PVC. ALEV YAYMAYAN KENDİNDEN MUFLU BOY BORU(3M)		102 mt.	1,549
001 045 110016 30 17	16 Ø PVC. ALEV YAYMAYAN KENDİNDEN MUFLU BOY BORU(3M)		102 mt.	1,619
001 045 110018 30 17	18 Ø PVC. ALEV YAYMAYAN KENDİNDEN MUFLU BOY BORU(3M)		102 mt.	1,897
001 045 110020 30 17	20 Ø PVC. ALEV YAYMAYAN KENDİNDEN MUFLU BOY BORU(3M)		102 mt.	2,238
001 045 110025 30 17	25 Ø PVC. ALEV YAYMAYAN KENDİNDEN MUFLU BOY BORU(3M)		51 mt.	3,161
001 045 110032 30 17	32 Ø PVC. ALEV YAYMAYAN KENDİNDEN MUFLU BOY BORU(3M)		30 mt.	4,601
001 045 110040 30 17	40 Ø PVC. ALEV YAYMAYAN KENDİNDEN MUFLU BOY BORU(3M)		30 mt.	8,157
HALOJEN FREE ALEV YAYMAYAN BOY BORULAR (320N) 				
001 045 500016 30 17	16 Ø PVC. A.YAYMAYAN BORU(3M) HALOJEN FREE (320N)		102 mt.	4.700
001 045 500020 30 17	20 Ø PVC. A.YAYMAYAN BORU(3M) HALOJEN FREE (320N)		102 mt.	5.768
001 045 500025 30 17	25 Ø PVC. A.YAYMAYAN BORU(3M) HALOJEN FREE (320N)		102 mt.	7.904
001 045 500032 30 17	32 Ø PVC. A.YAYMAYAN BORU(3M) HALOJEN FREE (320N)		102 mt.	11.246
001 045 500040 30 17	40 Ø PVC. A.YAYMAYAN BORU(3M) HALOJEN FREE (320N)		51 mt.	15.518
001 045 500050 30 17	50 Ø PVC. A.YAYMAYAN BORU(3M) HALOJEN FREE (320N)		30 mt.	33.141
HALOJEN FREE ALEV YAYMAYAN BOY BORULAR (750N) 				
001 045 510016 30 17	16 Ø PVC. A.YAYMAYAN BORU(3M) HALOJEN FREE (750N)		102 mt.	4.967
001 045 510020 30 17	20 Ø PVC. A.YAYMAYAN BORU(3M) HALOJEN FREE (750N)		102 mt.	6.302
001 045 510025 30 17	25 Ø PVC. A.YAYMAYAN BORU(3M) HALOJEN FREE (750N)		102 mt.	8.438
001 045 510032 30 17	32 Ø PVC. A.YAYMAYAN BORU(3M) HALOJEN FREE (750N)		102 mt.	11.780
001 045 510040 30 17	40 Ø PVC. A.YAYMAYAN BORU(3M) HALOJEN FREE (750N)		51 mt.	16.053
001 045 510050 30 17	50 Ø PVC. A.YAYMAYAN BORU(3M) HALOJEN FREE (750N)		30 mt.	33.733
HALOJEN FREE ALEV YAYMAYAN BOY BORULAR (1250N) 				
001 045 520016 30 17	16 Ø PVC. A.YAYMAYAN BORU(3M) HALOJEN FREE (1250N)		102 mt.	5.234
001 045 520020 30 17	20 Ø PVC. A.YAYMAYAN BORU(3M) HALOJEN FREE (1250N)		102 mt.	6.569
001 045 520025 30 17	25 Ø PVC. A.YAYMAYAN BORU(3M) HALOJEN FREE (1250N)		102 mt.	8.972
001 045 520032 30 17	32 Ø PVC. A.YAYMAYAN BORU(3M) HALOJEN FREE (1250N)		102 mt.	13.115
001 045 520040 30 17	40 Ø PVC. A.YAYMAYAN BORU(3M) HALOJEN FREE (1250N)		51 mt.	16.587
001 045 520050 30 17	50 Ø PVC. A.YAYMAYAN BORU(3M) HALOJEN FREE (1250N)		30 mt.	33.059
DİRSEK VE MUFLAR ALEV YAYMAYAN 				
001 051 010014 00 17	14 Ø DİRSEK ALEV YAYMAYAN		100 ad.	700 0,600
001 051 010016 00 17	16 Ø DİRSEK ALEV YAYMAYAN		100 ad.	600 0,633
001 051 010018 00 17	18 Ø DİRSEK ALEV YAYMAYAN		100 ad.	400 0,840
001 051 010020 00 17	20 Ø DİRSEK ALEV YAYMAYAN		100 ad.	300 0,922
001 051 010025 00 17	25 Ø DİRSEK ALEV YAYMAYAN		50 ad.	150 1,400
001 051 010032 00 17	32 Ø DİRSEK ALEV YAYMAYAN		50 ad.	100 2,220
001 051 030014 00 17	14-16 Ø MUF ALEV YAYMAYAN		100 ad.	700 0,561
001 051 030018 00 17	18-20 Ø MUF ALEV YAYMAYAN		100 ad.	700 0,809
001 051 030025 00 17	25 Ø MUF ALEV YAYMAYAN		50 ad.	300 0,875
001 051 030032 00 17	32 Ø MUF ALEV YAYMAYAN		50 ad.	200 0,966
GEÇMELİ TİP ANTİGRON BORU KROŞELERİ				
001 048 010016 00 17	16 Ø ANTİGRON BORU KROŞESİ (GEÇMELİ)		100 ad.	2000 0,192
001 048 010018 00 17	18 Ø ANTİGRON BORU KROŞESİ (GEÇMELİ)		100 ad.	4000 0,338
001 048 010020 00 17	20 Ø ANTİGRON BORU KROŞESİ (GEÇMELİ)		100 ad.	1500 0,207
001 048 010025 00 17	25 Ø ANTİGRON BORU KROŞESİ (GEÇMELİ)		100 ad.	1000 0,242
001 048 010032 00 17	32 Ø ANTİGRON BORU KROŞESİ (GEÇMELİ)		50 ad.	800 0,252
001 048 010040 00 17	40 Ø ANTİGRON BORU KROŞESİ (GEÇMELİ)		100 ad.	1000 0,607
074 048 050016	16 Ø ANTİGRON BORU KROŞESİ KAPAKLI(GEÇMELİ)		100 ad.	4000 0,306
074 048 050017	20 Ø ANTİGRON BORU KROŞESİ KAPAKLI(GEÇMELİ)		100 ad.	3000 0,306
074 048 050025	25 Ø ANTİGRON BORU KROŞESİ KAPAKLI(GEÇMELİ)		100 ad.	2500 0,454
074 048 050032	32 Ø ANTİGRON BORU KROŞESİ KAPAKLI(GEÇMELİ)		50 ad.	1500 0,470
ŞEFFAF H.FREE A.YAYAN BORU-SPİRAL EK MUF 				
999 999 777616	16 LİK ŞEFFAF H.F ALEV YAYAN BORU-SPİRAL EK MUFU		100 ad.	1,161
999 999 777620	20 LİK ŞEFFAF H.F ALEV YAYAN BORU-SPİRAL EK MUFU		100 ad.	1,295
999 999 777625	25 LİK ŞEFFAF H.F ALEV YAYAN BORU-SPİRAL EK MUFU		100 ad.	1,354
999 999 777632	32 LİK ŞEFFAF H.F ALEV YAYAN BORU-SPİRAL EK MUFU		100 ad.	1,682
DÜZ BORU T DİRSEK H.FREE ALEV YAYMAYAN 				
999 999 999888	16 Ø DÜZ BORU T DİRSEK H.FREE ALEV YAYMAYAN		100 ad.	300 1,915
999 999 999889	20 Ø DÜZ BORU T DİRSEK H.FREE ALEV YAYMAYAN		100 ad.	300 2,210
999 999 999890	25 Ø DÜZ BORU T DİRSEK H.FREE ALEV YAYMAYAN		100 ad.	300 2,374
999 999 999891	32 Ø DÜZ BORU T DİRSEK H.FREE ALEV YAYMAYAN		100 ad.	200 2,947
DÜZ BORU REKORU H.FREE ALEV YAYMAYAN 				
999 999 998816	16 Ø DÜZ BORU REKORU H.FREE		100 ad.	1,920
999 999 998820	20 Ø DÜZ BORU REKORU H.FREE		100 ad.	2,247
999 999 998825	25 Ø DÜZ BORU REKORU H.FREE		100 ad.	2,560
999 999 998832	32 Ø DÜZ BORU REKORU H.FREE		100 ad.	3,200
ANTİGRON BORU KROŞESİ (GEÇMELİ) H.FREE A.YAYMAYAN 				
074 048 060016	16 Ø ANT. BORU KROŞESİ(GEÇMELİ) KAPAKLI H.FREE A.YAYMAYAN		100 ad.	0,387
074 048 060020	20 Ø ANT. BORU KROŞESİ(GEÇMELİ) KAPAKLI H.FREE A.YAYMAYAN		100 ad.	0,446
074 048 060025	25 Ø ANT. BORU KROŞESİ(GEÇMELİ) KAPAKLI H.FREE A.YAYMAYAN		100 ad.	0,506
074 048 060032	32 Ø ANT. BORU KROŞESİ(GEÇMELİ) KAPAKLI H.FREE A.YAYMAYAN		50 ad.	0,580
SPİRAL REKORU H.FREE ALEV YAYMAYAN 				
999 999 777516	16 Ø SPİRAL REKORU KAPAKLI H.FREE A.YAYMAYAN		100 ad.	1,607
999 999 777520	20 Ø SPİRAL REKORU KAPAKLI H.FREE A.YAYMAYAN		100 ad.	2,247
999 999 777525	25 Ø SPİRAL REKORU KAPAKLI H.FREE A.YAYMAYAN		100 ad.	2,887
999 999 777532	32 Ø SPİRAL REKORU KAPAKLI H.FREE A.YAYMAYAN		50 ad.	3,840



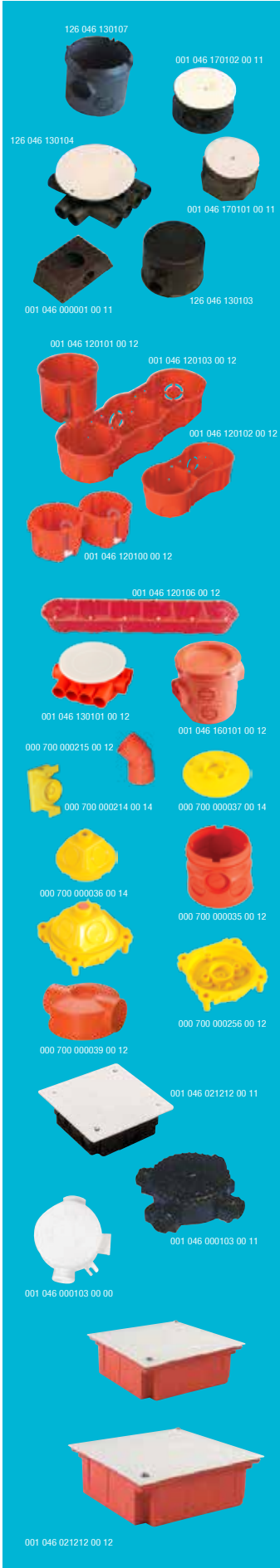

Kod	Açıklama / Stok Cinsi	Amb. (Kutu)	Amb. Birimi	FİYAT
PLASTİK KASA-BUAT-TAKOZLAR				
126 046 130103	NORM KASA	100 ad.	1000	0,233
126 046 130104	NORM BUAT (14-18 ÇIKIŞLI)	50 ad.	500	0,465
126 046 130105	NORM BUAT KAPAKSIZ	50 ad.	500	0,393
001 046 160102 00 11	GEÇMELİ PLASTİK KASA	100 ad.	400	0,575
126 046 130106	GEÇMELİ DERİN KASA	100 ad.	500	0,465
126 046 130107	GEÇMELİ DERİN KASA KAPAKSIZ	100 ad.	500	0,393
001 046 120101 00 11	ALÇIPAN KASA 1'Lİ	75 ad.	300	1,125
001 046 120102 00 11	ALÇIPAN KASA 2'Lİ	50 ad.	200	1,494
001 046 120103 00 11	ALÇIPAN KASA 3'Lİ	25 ad.	100	1,975
001 046 120100 00 11	GEÇMELİ ALÇ.KASA SİYAH	50 ad.	300	1,023
001 046 170101 00 11	TÜNEL KASA	100 ad.	500	1,118
001 046 170102 00 11	TÜNEL BUAT	50 ad.	300	0,581
001 046 000001 00 11	PLASTİK TAKOZ (14-18 ÇIKIŞLI)	100 ad.	1000	0,311
TURUNCU KASA VE BUATLAR H.FREE (ALEV YAYMAYAN) 				
001 046 131202 00 12	NORM KASA (TURUNCU) (H.FREE) (ALEV YAYMAYAN)	100 ad.	1000	0,451
001 046 131201 00 12	NORM BUAT (TURUNCU) (H.FREE) (ALEV YAYMAYAN)	50 ad.	500	0,831
001 046 161201 00 12	GEÇMELİ DERİN KASA (TURUNCU) (H.FREE) (ALEV YAYMAYAN)	100 ad.	400	0,831
TURUNCU KASA VE BUATLAR H.FREE (ALEV YAYAN) 				
001 046 130202 00 12	NORM KASA (TURUNCU) (H.FREE) (ALEV YAYAN)	100 ad.	1000	0,363
001 046 130201 00 12	NORM BUAT (TURUNCU) (H.FREE) (ALEV YAYAN)	50 ad.	500	0,725
001 046 160201 00 12	GEÇMELİ DERİN KASA (TURUNCU) (H.FREE) (ALEV YAYAN)	100 ad.	400	0,688
TURUNCU KASA VE BUATLAR (ALEV YAYAN)				
001 046 130102 00 12	NORM KASA (TURUNCU)(ALEV YAYAN)	100 ad.	1000	0,342
001 046 130101 00 12	NORM BUAT (TURUNCU)(ALEV YAYAN)	50 ad.	500	0,650
001 046 160102 00 12	GEÇMELİ PLASTİK KASA (TURUNCU)(ALEV YAYAN)	100 ad.	400	0,865
001 046 160101 00 12	GEÇMELİ DERİN KASA (TURUNCU)(ALEV YAYAN)	100 ad.	500	0,650
001 046 170101 00 12	TÜNEL KASA (TURUNCU)(ALEV YAYAN)	100 ad.	500	2,130
001 046 170102 00 12	TÜNEL BUAT (TURUNCU)(ALEV YAYAN)	50 ad.	300	1,125
001 046 120101 00 12	ALÇIPAN KASA 1'Lİ (TURUNCU)(ALEV YAYAN)	75 ad.	300	1,330
001 046 120102 00 12	ALÇIPAN KASA 2'Lİ (TURUNCU)(ALEV YAYAN)	50 ad.	200	1,985
001 046 120103 00 12	ALÇIPAN KASA 3'LÜ (TURUNCU)(ALEV YAYAN)	25 ad.	100	2,945
001 046 120104 00 12	ALÇIPAN KASA 4'LÜ (TURUNCU)(ALEV YAYAN)	28 ad.	500	5,727
001 046 120105 00 12	ALÇIPAN KASA 5'Lİ (TURUNCU)(ALEV YAYAN)	24 ad.	500	6,965
001 046 120106 00 12	ALÇIPAN KASA 6'Lİ (TURUNCU)(ALEV YAYAN)	20 ad.	500	8,203
001 046 120100 00 12	GEÇMELİ ALÇIPAN KASA (TURUNCU)(ALEV YAYAN)	50 ad.	300	1,282
TURUNCU KASA VE BUATLAR (ALEV YAYMAYAN) 				
001 046 131102 00 12	NORM KASA (TURUNCU)(ALEV YAYMAYAN)	 100 ad.	1000	0,428
001 046 131101 00 12	NORM BUAT (TURUNCU)(ALEV YAYMAYAN)	 50 ad.	500	0,788
001 046 161102 00 12	GEÇMELİ PLASTİK KASA (TURUNCU)(ALEV YAYMAYAN)	 100 ad.	400	0,693
001 046 161101 00 12	GEÇMELİ DERİN KASA (TURUNCU)(ALEV YAYMAYAN)	 100 ad.	500	0,788
001 046 210002 00 12	TÜNEL KASA (TURUNCU)(ALEV YAYMAYAN)	 100 ad.	500	2,278
001 046 210003 00 12	TÜNEL BUAT (TURUNCU)(ALEV YAYMAYAN)	 50 ad.	300	1,294
001 046 121101 00 12	ALÇIPAN KASA 1'Lİ (TURUNCU)(ALEV YAYMAYAN)	 75 ad.	300	1,414
001 046 121102 00 12	ALÇIPAN KASA 2'Lİ (TURUNCU)(ALEV YAYMAYAN)	 50 ad.	200	1,733
001 046 121103 00 12	ALÇIPAN KASA 3'LÜ (TURUNCU)(ALEV YAYMAYAN)	 25 ad.	100	2,237
001 046 121100 00 12	GEÇMELİ ALÇIPAN KASA (TURUNCU)(ALEV YAYMAYAN)	 50 ad.	300	1,432
BETON DUVAR ANAHTAR KASALARI (ALEV YAYAN)				
000 700 000037 00 14	BUAT ARKA KAPAK SARI (ALEV YAYAN)	50 ad.	500	0,428
000 700 000035 00 12	BUAT GÖVDE 60'LİK TURUNCU (ALEV YAYAN)	50 ad.	350	0,616
000 700 000256 00 14	KALIBA TESPİT ELEMANI SARI (ALEV YAYAN)		250	0,548
000 700 000039 00 12	SİĞ BRÜT ANAH. KASASI TURUNCU (ALEV YAYAN)	100 ad.	500	1,013
000 700 000036 00 14	KONİK GÖVDE SARI (ALEV YAYAN)	50 ad.	250	0,595
000 700 000214 00 14	APLİK 20'LİK SARI (ALEV YAYAN)	100 ad.	1000	0,344
000 700 000215 00 12	APLİK EĞİK BAĞLANTI DIRSEĞİ TURUNCU (ALEV YAYAN)	100 ad.	1000	0,286
BETON DUVAR ANAHTAR KASALARI (ALEV YAYMAYAN) 				
000 700 200037 00 14	BUAT ARKA KAPAK SARI (ALEV YAYMAYAN)	 50 ad.	500	0,692
000 700 200035 00 12	BUAT GÖVDE 60'LİK TURUNCU (ALEV YAYMAYAN)	 50 ad.	350	0,866
000 700 200256 00 14	KALIBA TESPİT ELEMANI SARI (ALEV YAYMAYAN)	 250	0,709	
000 700 200039 00 12	SİĞ BRÜT ANAH. KASASI TURUNCU (ALEV YAYMAYAN)	 100 ad.	500	1,266
000 700 200036 00 14	KONİK GÖVDE SARI (ALEV YAYMAYAN)	 50 ad.	250	0,656
000 700 200214 00 14	APLİK 20'LİK SARI (ALEV YAYMAYAN)	 100 ad.	1000	0,515
000 700 200215 00 12	APLİK EĞİK BAĞLANTI DIRSEĞİ TURUNCU (ALEV YAYMAYAN)	 100 ad.	1000	0,517
KARE BUAT				
001 046 021010 00 11	10X10 KARE BUAT	10 ad.	300	2,210
001 046 021212 00 11	12X12 KARE BUAT	10 ad.	200	2,755
001 046 021515 00 11	15X15 KARE BUAT	10 ad.	120	7,379
001 046 022020 00 11	20X20 KARE BUAT	10 ad.	70	9,455
001 046 000103 00 11	ANTİGRON BUAT 3'LÜ PLASTİK (SİYAH)	10 ad.	240	1,323
001 046 000104 00 11	ANTİGRON BUAT 4'LÜ PLASTİK (SİYAH)	10 ad.	240	0,959
001 046 000103 00 00	ANTİGRON BUAT 3'LÜ PLASTİK (BEYAZ)	10 ad.	240	1,352
001 046 000104 00 00	ANTİGRON BUAT 4'LÜ PLASTİK (BEYAZ)	10 ad.	240	1,059
TURUNCU KARE BUAT				
001 046 021010 00 12	10X10 KARE BUAT TURUNCU	10 ad.	300	2,032
001 046 021212 00 12	12X12 KARE BUAT TURUNCU	10 ad.	200	2,203
001 046 021515 00 12	15X15 KARE BUAT TURUNCU	10 ad.	120	4,898
001 046 022020 00 12	20X20 KARE BUAT TURUNCU	10 ad.	70	7,618
001 046 000103 00 12	ANTİGRON BUAT 3'LÜ TURUNCU	10 ad.	240	1,368
001 046 000104 00 12	ANTİGRON BUAT 4'LÜ TURUNCU	10 ad.	240	1,211
TURUNCU KARE BUAT (A.YAYMAYAN) 				
001 046 051010 00 12	KARE BUAT TURUNCU(10X10) (A.YAYMAYAN)	10 ad.	300	2,107
001 046 051212 00 12	KARE BUAT TURUNCU(12X12) (A.YAYMAYAN)	10 ad.	200	3,103
001 046 051515 00 12	KARE BUAT TURUNCU(15X15) (A.YAYMAYAN)	10 ad.	120	6,125
001 046 052020 00 12	KARE BUAT TURUNCU(20X20) (A.YAYMAYAN)	10 ad.	70	8,868



Kod	Açıklama / Stok Cinsi	Amb. Kutu/Bağ	Amb. Koli/Çv	FİYAT
KARE BUAT KAPAKLARI				
000 700 000043 00 00	10X10 KARE BUAT KAPAĞI	1 ad.	300	0.957
000 700 000045 00 00	12X12 KARE BUAT KAPAĞI	1 ad.	200	0.957
000 700 000047 00 00	15X15 KARE BUAT KAPAĞI	1 ad.	200	1.958
000 700 000049 00 00	20X20 KARE BUAT KAPAĞI	1 ad.	100	1.971
LÜX BUAT KAPAKLARI				
126 046 180001	LÜX BUAT KAPAĞI(BOMBELİ-PLS. AYAK)	100 ad.	1000	0,328
126 046 180002	LÜX BUAT KAPAĞI(BOMBELİ-SAC AYAK)	100 ad.	1000	0,616
126 046 180003	LÜX BUAT KAPAĞI(DÜZ PLS. AYAK)	100 ad.	1000	0,342
126 046 180004	LÜX BUAT KAPAĞI(BOMB.PLS.AYAK)VİDALI	100 ad.	1000	0,514
FİBER SUSTALAR				
999 999 000779	FİBER KLAVUZ 11MM (100-120-150-200M)	1 mt.		3.572 \$
999 999 000780	FİBER KLAVUZ MAKARASI	1 ad.		193.471 \$
PVC.İZOLE KAPLI ÇELİK SUSTA				
049 019 300010	10 MT. PVC.İZOLE KAPLI ÇELİK SUSTA	1 ad.	30	44,647
049 019 300015	15 MT. PVC.İZOLE KAPLI ÇELİK SUSTA	1 ad.	24	66,971
049 019 300020	20 MT. PVC.İZOLE KAPLI ÇELİK SUSTA	1 ad.	20	89,294
049 019 300025	25 MT. PVC.İZOLE KAPLI ÇELİK SUSTA	1 ad.	18	111,618
PLASTİK SUSTALAR (KILAVUZ TELLİ)				
049 019 400010	10 MT.KILAVUZ TELLİ PLASTİK SUSTA	1 ad.	25	12,299
049 019 400015	15 MT.KILAVUZ TELLİ PLASTİK SUSTA	1 ad.	20	17,680
049 019 400020	20 MT.KILAVUZ TELLİ PLASTİK SUSTA	1 ad.	15	24,257
049 019 400025	25 MT KILAVUZ TELLİ PLASTİK SUSTA	1 ad.	15	30,748
ÇELİK SUSTA VE ZİNCİR				
001 019 000010 00 00	SUSTA (1.KALİTE) (10M)	40 ad.	40	19,325
001 019 000015 00 00	SUSTA (1.KALİTE) (15M)	30 ad.	30	27,818
001 019 000020 00 00	SUSTA (1.KALİTE) (20M)	20 ad.	20	36,332
001 019 000025 00 00	SUSTA (1.KALİTE) (25M)	15 ad.	15	44,845
001 019 100010 00 00	TAKVİYELİ SUSTA(1.KALİTE)(10M)	40 ad.	40	23,575
001 019 100015 00 00	TAKVİYELİ SUSTA(1.KALİTE)(15M)	30 ad.	30	34,077
001 019 100020 00 00	TAKVİYELİ SUSTA(1.KALİTE)(20M)	20 ad.	20	44,740
001 019 100025 00 00	TAKVİYELİ SUSTA(1.KALİTE)(25M)	15 ad.	15	55,116
001 018 000001 00 00	FLORESAN ZİNCİRİ	100 mt.	500	0,952
BASINÇ ŞALTERLERİ VE SU SEVİYE FLATÖRLERİ				
011 095 000500	LM5 (1-6 BAR) MONOFAZE BASINÇ ŞALTERİ 1/4	1 ad.		40,288
011 095 000600	LM6 (2-9 BAR) MONOFAZE BASINÇ ŞALTERİ 1/4	1 ad.		42,703
011 095 000601	LM5 (2-9 BAR) MONOFAZE BSN. ŞALTERİ THL. 1/2	1 ad.		44,294
011 095 000100	LM1 (1-5 BAR) BASINÇ ŞALTERİ TAHLİYESİZ 1/2	1 ad.		40,288
011 095 000101	LM1 (1-5 BAR) BASINÇ ŞALTERİ TAHLİYELİ 1/2	1 ad.		42,703
011 095 000200	LM2 (2-8 BAR) BASINÇ ŞALTERİ TAHLİYESİZ 1/2	1 ad.		49,124
011 095 000201	LM2 (2-8 BAR) BASINÇ ŞALTERİ TAHLİYELİ 1/2	1 ad.		53,158
011 095 000300	LM3 (3-11 BAR) BASINÇ ŞALTERİ TAHLİYESİZ1/2	1 ad.		49,124
011 095 000301	LM3 (3-11 BAR) BASINÇ ŞALTERİ TAHLİYELİ 1/2	1 ad.		53,158
011 095 000400	LM4 (4-16 BAR) BASINÇ ŞALTERİ TAHLİYESİZ 1/2	1 ad.		49,124
011 095 000401	LM4 (4-16 BAR) BASINÇ ŞALTERİ TAHLİYELİ 1/2	1 ad.		53,158
011 096 000591	SU SEVİYE FLATÖRÜ (0,6M TTR KABLOLU)	1 ad.		26,593
011 096 000592	SU SEVİYE FLATÖRÜ (1,6M TTR KABLOLU)	1 ad.		33,838
011 096 000593	SU SEVİYE FLATÖRÜ (3M TTR KABLOLU)	1 ad.		38,668
011 096 000590	SU SEVİYE FLATÖRÜ (5M TTR KABLOLU)	1 ad.		48,328
011 096 000594	SU SEVİYE FLATÖRÜ (10M TTR KABLOLU)	1 ad.		79,752
011 096 000595	ATIK SU SEVİYE FLATÖRÜ (3 MT KAUÇUK KABLOLU)	1 ad.		93,446
011 096 000596	ATIK SU SEVİYE FLATÖRÜ (5 MT KAUÇUK KABLOLU)	1 ad.		103,106
011 096 000597	ATIK SU SEVİYE FLATÖRÜ (10 MT KAUÇUK KABLOLU)	1 ad.		141,775
011 096 000598	ATIK SU SEVİYE FLATÖRÜ (15 MT KAUÇUK KABLOLU)	1 ad.		180,415
ŞALTERLER				
041 118 000201	MONOFAZE ŞALTER	1 ad.	100	15,180
041 118 000200	TRİFAZE ŞALTER	1 ad.	50	25,895
SAYAÇ KUTULARI				
047 089 010855	MONOFAZE MODÜLER SAYAÇ KUTUSU(215X405X115) MM	1 ad.		79,780
047 089 010856	TRİFAZE SAYAÇ KUTUSU(540X350X130) MM	1 ad.		122,182
047 089 010843	LÜKS MONOFAZE DİJİTAL SAYAÇ KUTUSU	1 ad.		30,509
047 089 010844	LÜKS MONOFAZE DİJİTAL MEKANİK SAYAÇ KUTUSU	1 ad.		30,996
047 089 010845	LÜKS MONOFAZE DİJİTAL MEKANİK SAYAÇ KUTUSU S/A	1 ad.		28,844
047 089 010841	LÜKS TRİFAZE DİJİTAL MEKANİK SAYAÇ KUTUSU	1 ad.		44,913
DEVRE KESEN VE NH00 KAİDELER				
025 110 000001	TRİFAZE DEVRE KESEN	1 ad.		50,005
025 110 000002	MONOFAZE DEVRE KESEN	2 ad.		27,559
025 110 000003	TEK KOFRA	1 ad.		86,656
025 110 000004	NH00 BOY KAİDE	6 ad.		8,524
025 110 000005	NH00 BOY BIÇAKLI SİG.(32A.-160A.)	10 ad.		9,234
025 110 000025	NH POLYESTER YER ALTI KOFRA (KESİCİLİ)	1 ad.		218,768

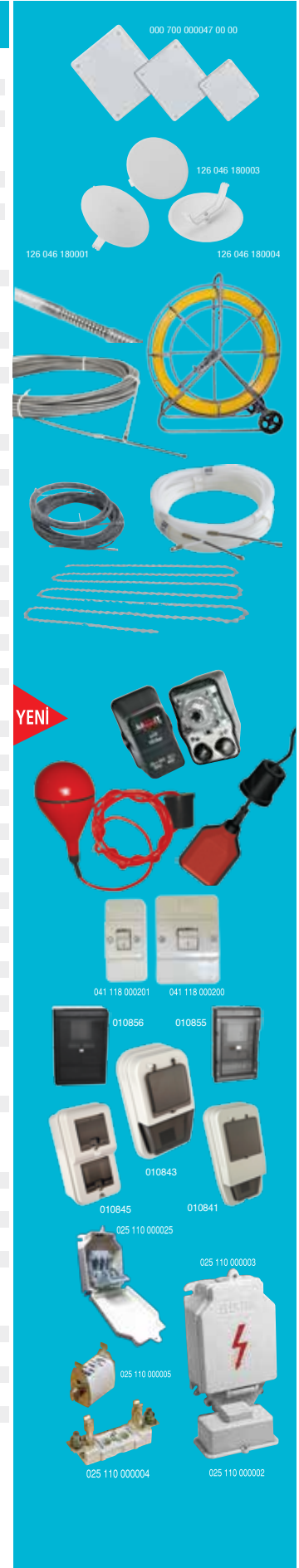

COMFORT SİGORTA VE ZAYIF AKIM KUTULARIMIZ İLE
**KENDİNİZİ GÜVENDE
HİSSEDİN**



225x270(İç Ölçü)
Zayıf Akım Kut. (S/Ü)



12'li Sigorta+Zayıf Akım
Kutusu (S/Ü)



24'lü Sigorta+Zayıf Akım
Kutusu (S/Ü)

KENDİNİZİ GÜVENDE HİSSEDEBİLECEĞİNİZ
**SAC ZAYIF AKIM
KUTULARI**





Kod	Açıklama / Stok Cinsi	Amb. Kutu/Bağ	Amb. Kolu/Çv	FİYAT
COMFORT W OTOMAT KUTULARI IP40				
001 057 200001 00 00	COMFORT MÜH. SİGORTA KUTUSU(S/Ü) 1 Lİ	20 ad.	120	3,021
001 057 200002 00 00	COMFORT MÜH. SİGORTA KUTUSU(S/Ü) 1-2 Lİ	20 ad.	80	3,525
001 057 200004 00 00	COMFORT MÜH. SİGORTA KUTUSU(S/Ü) 2-4 Lİ	10 ad.	60	4,435
001 057 100006 00 00	COMFORT SİGORTA KUTUSU (S/Ü) 6 Lİ	1 ad.	20	20,733
001 057 100009 00 00	COMFORT SİGORTA KUTUSU (S/Ü) 9 LÜ	1 ad.	20	24,471
001 057 100012 00 00	COMFORT SİGORTA KUTUSU (S/Ü) 12 Lİ	1 ad.	10	33,084
001 057 100018 00 00	COMFORT SİGORTA KUTUSU (S/Ü) 18 Lİ	1 ad.	10	47,840
001 057 100024 00 00	COMFORT SİGORTA KUTUSU (S/Ü) 24 LÜ	1 ad.	5	55,993
001 057 100036 00 00	COMFORT SİGORTA KUTUSU (S/Ü) 36 Lİ	1 ad.	5	73,241
001 057 000006 00 00	COMFORT SİGORTA KUTUSU (S/A) 6 Lİ	1 ad.	20	19,998
001 057 000009 00 00	COMFORT SİGORTA KUTUSU (S/A) 9 LÜ	1 ad.	20	23,900
001 057 000012 00 00	COMFORT SİGORTA KUTUSU (S/A) 12 Lİ	1 ad.	10	32,126
001 057 000018 00 00	COMFORT SİGORTA KUTUSU (S/A) 18 Lİ	1 ad.	10	45,071
001 057 000024 00 00	COMFORT SİGORTA KUTUSU (S/A) 24 LÜ	1 ad.	5	54,879
001 057 000036 00 00	COMFORT SİGORTA KUTUSU (S/A) 36 Lİ	1 ad.	5	71,654
COMFORT W OTOMAT KUTULARI (ALEV YAYMAYAN) IP40				
001 057 210001 00 00	COMFORT MÜH. SİGORTA (A.YAYMAYAN)(S/Ü) 1 Lİ	20 ad.	120	4,003
001 057 210002 00 00	COMFORT MÜH. SİGORTA (A.YAYMAYAN)(S/Ü) 1-2 Lİ	20 ad.	80	4,704
001 057 210004 00 00	COMFORT MÜH. SİGORTA (A.YAYMAYAN)(S/Ü) 2-4 LÜ	10 ad.	60	6,133
001 057 110006 00 00	COMFORT SİGORTA KUTUSU(S/Ü)(A.YAYMAYAN) 6 Lİ	1 ad.	20	29,298
001 057 110009 00 00	COMFORT SİGORTA KUTUSU(S/Ü)(A.YAYMAYAN) 9 LÜ	1 ad.	20	35,964
001 057 110012 00 00	COMFORT SİGORTA KUTUSU(S/Ü)(A.YAYMAYAN) 12 Lİ	1 ad.	10	49,495
001 057 110018 00 00	COMFORT SİGORTA KUTUSU(S/Ü)(A.YAYMAYAN) 18 Lİ	1 ad.	10	73,220
001 057 110024 00 00	COMFORT SİGORTA KUTUSU(S/Ü)(A.YAYMAYAN) 24 LÜ	1 ad.	5	82,625
001 057 110036 00 00	COMFORT SİGORTA KUTUSU(S/Ü)(A.YAYMAYAN) 36 Lİ	1 ad.	5	103,923
001 057 010006 00 00	COMFORT SİGORTA KUTUSU(S/A) A.YAYMAYAN 6 Lİ	1 ad.	20	28,447
001 057 010009 00 00	COMFORT SİGORTA KUTUSU(S/A) A.YAYMAYAN 9 LÜ	1 ad.	20	34,818
001 057 010012 00 00	COMFORT SİGORTA KUTUSU(S/A) A.YAYMAYAN 12 Lİ	1 ad.	10	47,640
001 057 010018 00 00	COMFORT SİGORTA KUTUSU(S/A) A.YAYMAYAN 18 Lİ	1 ad.	10	67,921
001 057 010024 00 00	COMFORT SİGORTA KUTUSU(S/A) A.YAYMAYAN 24 LÜ	1 ad.	5	78,816
001 057 010036 00 00	COMFORT SİGORTA KUTUSU(S/A) A.YAYMAYAN 36 Lİ	1 ad.	5	100,306
COMFORT W OTOMAT KUTULARI H.FREE (ALEV YAYAN) IP40				
001 057 220001 00 00	COMFORT MÜH. SİGORTA KUTUSU H.FREE (ALEV YAYAN)(S/Ü) 1 Lİ	20 ad.	120	3,264
001 057 220002 00 00	COMFORT MÜH. SİGORTA KUTUSU H.FREE (ALEV YAYAN)(S/Ü) 1-2 Lİ	20 ad.	80	3,808
001 057 220004 00 00	COMFORT MÜH. SİGORTA KUTUSU H.FREE (ALEV YAYAN)(S/Ü) 2-4 Lİ	10 ad.	60	4,790
001 057 120006 00 00	COMFORT SİGORTA KUTUSU H.FREE (ALEV YAYAN) (S/Ü) 6 Lİ	1 ad.	20	23,755
001 057 120009 00 00	COMFORT SİGORTA KUTUSU H.FREE (ALEV YAYAN) (S/Ü) 9 LÜ	1 ad.	20	28,037
001 057 120012 00 00	COMFORT SİGORTA KUTUSU H.FREE (ALEV YAYAN) (S/Ü) 12 Lİ	1 ad.	10	37,907
001 057 120018 00 00	COMFORT SİGORTA KUTUSU H.FREE (ALEV YAYAN) (S/Ü) 18 Lİ	1 ad.	10	54,813
001 057 120024 00 00	COMFORT SİGORTA KUTUSU H.FREE (ALEV YAYAN) (S/Ü) 24 LÜ	1 ad.	5	64,438
001 057 120036 00 00	COMFORT SİGORTA KUTUSU H.FREE (ALEV YAYAN) (S/Ü) 36 Lİ	1 ad.	5	84,288
001 057 020006 00 00	COMFORT SİGORTA KUTUSU H.FREE (ALEV YAYAN) (S/A) 6 Lİ	1 ad.	20	22,913
001 057 020009 00 00	COMFORT SİGORTA KUTUSU H.FREE (ALEV YAYAN) (S/A) 9 LÜ	1 ad.	20	27,383
001 057 020012 00 00	COMFORT SİGORTA KUTUSU H.FREE (ALEV YAYAN) (S/A) 12 Lİ	1 ad.	10	36,810
001 057 020018 00 00	COMFORT SİGORTA KUTUSU H.FREE (ALEV YAYAN) (S/A) 18 Lİ	1 ad.	10	59,586
001 057 020024 00 00	COMFORT SİGORTA KUTUSU H.FREE (ALEV YAYAN) (S/A) 24 LÜ	1 ad.	5	63,155
001 057 020036 00 00	COMFORT SİGORTA KUTUSU H.FREE (ALEV YAYAN) (S/A) 36 Lİ	1 ad.	5	82,460
COMFORT W OTOMAT ZAYIF AKIM KUTULARI IP40				
001 057 101012 00 00	COMFORT ZAYIF AKIM KUTUSU (S/Ü)(225x270)	1 ad.	10	32,200
001 057 101020 00 00	COMFORT ZAYIF AKIM KUTUSU (S/Ü)(270x340)			HAZIRLIKTA
001 057 101024 00 00	COMFORT 12 Lİ SİGORTA + ZAYIF AKIM KUTUSU (S/Ü)	1 ad.	5	60,854
001 057 101036 00 00	COMFORT 24 LÜ SİGORTA + ZAYIF AKIM KUTUSU (S/Ü)	1 ad.	5	83,296
001 057 001012 00 00	COMFORT ZAYIF AKIM KUTUSU (S/A)(205x250)	1 ad.	10	30,725
001 057 001020 00 00	COMFORT ZAYIF AKIM KUTUSU (S/A)(243x318)			HAZIRLIKTA
001 057 001024 00 00	COMFORT 12 Lİ SİGORTA + ZAYIF AKIM KUTUSU (S/A)	1 ad.	5	58,963
001 057 001036 00 00	COMFORT 24 LÜ SİGORTA + ZAYIF AKIM KUTUSU (S/A)	1 ad.	5	81,045
COMFORT W OTOMAT ZAYIF AKIM KUTULARI H.FREE (ALEV YAYAN) IP40				
001 057 121012 00 00	COMFORT ZAYIF AKIM KUTUSU H.FREE (ALEV YAYAN) (S/Ü)(225x270)	1 ad.	10	36,167
001 057 121020 00 00	COMFORT ZAYIF AKIM KUTUSU H.FREE (ALEV YAYAN) (S/Ü)(270x340)			HAZIRLIKTA
001 057 121024 00 00	COMFORT 12 Lİ SİGORTA + ZAYIF AKIM KUTUSU H.FREE (ALEV YAYAN) (S/Ü)	1 ad.	5	60,855
001 057 121036 00 00	COMFORT 24 LÜ SİGORTA + ZAYIF AKIM KUTUSU H.FREE (ALEV YAYAN) (S/Ü)	1 ad.	5	83,298
001 057 021012 00 00	COMFORT ZAYIF AKIM KUTUSU H.FREE (ALEV YAYAN) (S/A)(205x250)	1 ad.	10	34,511
001 057 021020 00 00	COMFORT ZAYIF AKIM KUTUSU H.FREE (ALEV YAYAN) (S/A)(243x318)			HAZIRLIKTA
001 057 021024 00 00	COMFORT 12 Lİ SİGORTA + ZAYIF AKIM KUTUSU H.FREE (ALEV YAYAN) (S/A)	1 ad.	5	58,963
001 057 021036 00 00	COMFORT 24 LÜ SİGORTA + ZAYIF AKIM KUTUSU H.FREE (ALEV YAYAN) (S/A)	1 ad.	5	81,044
COMFORT W OTOMAT ZAYIF AKIM KUTULARI (ALEV YAYMAYAN) IP40				
001 057 111012 00 00	COMFORT ZAYIF AKIM KUTUSU(A.YAYMAYAN)(S/Ü)(225x270)	1 ad.	10	49,317
001 057 111020 00 00	COMFORT ZAYIF AKIM KUTUSU(A.YAYMAYAN)(S/Ü)(270x340)			HAZIRLIKTA
001 057 111024 00 00	COMFORT 12 Lİ SİGORTA + ZAYIF AKIM KUTUSU(A.YAYMAYAN)(S/Ü)	1 ad.	5	69,990
001 057 111036 00 00	COMFORT 24 LÜ SİGORTA + ZAYIF AKIM KUTUSU(A.YAYMAYAN)(S/Ü)	1 ad.	5	94,709
001 057 011012 00 00	COMFORT ZAYIF AKIM KUTUSU(A.YAYMAYAN)(S/A)(205x250)	1 ad.	10	46,854
001 057 011020 00 00	COMFORT ZAYIF AKIM KUTUSU(A.YAYMAYAN)(S/A)(243x318)			HAZIRLIKTA
001 057 011024 00 00	COMFORT 12 Lİ SİGORTA + ZAYIF AKIM KUTUSU(A.YAYMAYAN)(S/A)	1 ad.	5	71,928
001 057 011036 00 00	COMFORT 24 LÜ SİGORTA + ZAYIF AKIM KUTUSU(A.YAYMAYAN)(S/A)	1 ad.	5	97,824
COMFORT W OTOMAT KUTUSU AKSESUARLARI				
001 057 990001 00 00	S/A COMFORT ALÇIPAN MONTAJ SETİ	1 ad.		1,976
001 057 990002 00 00	COMFORT SU TERAZİSİ	1 ad.		3,850
000 700 000574 00 00	RAY YÜKSELTME PARÇASI (UZUN/KISA)	1 ad.		0,550
001 057 990001 00 00	COMFORT ZAYIF AKIM ÖRTME PARÇASI	50 ad.		4,200

Kod	Açıklama / Stok Cinsi	Amb. Kutu/Bağ	Amb. Kabi/Çvt	FİYAT
COMFORT W OTOMAT ZAYIF AKIM KUTULARI (METAL)				
IP20				
001 058 000012 00 00	12'Lİ SIVA ALTI METAL TABANLI + PLASTİK KAPAKLI OTOMATİK SİGORTA KUTUSU			61,14
001 058 001012 00 00	SIVA ALTI METAL TABANLI + PLASTİK KAPAKLI ZAYIF AKIM KUTUSU (12'Lİ OTOMATİK SİGORTA KUTUSU ÖLÇÜSÜNDE)			61,14
001 058 000024 00 00	24'LÜ SIVA ALTI METAL TABANLI + PLASTİK KAPAKLI OTOMATİK SİGORTA KUTUSU			92,89
001 058 001024 00 00	12 SİGORTALI + ZAYIF AKIM BÖLMELİ SIVA ALTI METAL TABANLI + PLASTİK KAPAKLI KUTU (24'LÜ OTOMATİK SİGORTA KUTUSU ÖLÇÜSÜNDE)			92,89
001 058 000036 00 00	36'Lİ SIVA ALTI METAL TABANLI + PLASTİK KAPAKLI OTOMATİK SİGORTA KUTUSU			113,45
001 058 001036 00 00	24 SİGORTALI + ZAYIF AKIM BÖLMELİ SIVA ALTI METAL TABANLI + PLASTİK KAPAKLI KUTU (36'Lİ OTOMATİK SİGORTA KUTUSU ÖLÇÜSÜNDE)			113,45
001 058 602532 00 00	250 MM X 320 MM METAL SIVA ALTI ZAYIF AKIM KUTUSU (24'LÜ OTOMATİK SİGORTA KUTUSU ÖLÇÜSÜNDE)			132,35
001 058 502532 00 00	250 MM X 320 MM SIVA ALTI METAL TABAN + PLASTİK KAPAKLI ZAYIF AKIM KUTUSU (24'LÜ OTOMATİK SİGORTA KUTUSU ÖLÇÜSÜNDE)			93,50
001 058 602544 00 00	250 MM X 440 MM METAL SIVA ALTI ZAYIF AKIM KUTUSU			179,41
001 058 604040 00 00	400 MM X 400 MM SIVA ALTI METAL ZAYIF AKIM KUTUSU			182,35
001 058 400036 00 00	24 SİGORTALI + ZAYIF AKIM BÖLMELİ SIVA ALTI METAL KUTU			288,24
001 058 400048 00 00	36 SİGORTALI + ZAYIF AKIM BÖLMELİ SIVA ALTI METAL KUTU			358,82



ÖRTME PARÇALARI

001 026 000002 00 00	W OTOMAT ÖRTME PARÇASI (12'Lİ) YENİ TİP	50 ad.	400	0,970
----------------------	---	--------	-----	-------

MEKSBOX W OTOMAT KUTULARI

001 027 200001 00 00	MÜHÜRLÜ W OTOMAT KUTUSU (S/Ü) 1 Lİ	IP30	20 ad.	160	2,176
001 027 200002 00 00	MÜHÜRLÜ W OTOMAT KUTUSU (S/Ü) 2 Lİ		20 ad.	80	3,041
001 027 200004 00 00	MÜHÜRLÜ W OTOMAT KUTUSU (S/Ü) 4 LÜ		10 ad.	80	4,512
001 027 100002 00 00	W OTOMAT KUTUSU (S/Ü) MEKSBOX 2 Lİ		1 ad.	30	10,901
001 027 000002 00 00	W OTOMAT KUTUSU (S/A) MEKSBOX 2 Lİ		1 ad.	30	10,607
001 027 100004 00 00	W OTOMAT KUTUSU (S/Ü) MEKSBOX 4 LÜ		1 ad.	20	12,948
001 027 000004 00 00	W OTOMAT KUTUSU (S/A) MEKSBOX 4 LÜ		1 ad.	20	11,126
001 027 100006 00 00	W OTOMAT KUTUSU (S/Ü) MEKSBOX 6 Lİ		1 ad.	20	17,763
001 027 000006 00 00	W OTOMAT KUTUSU (S/A) MEKSBOX 6 Lİ		1 ad.	20	15,448
001 027 100009 00 00	W OTOMAT KUTUSU (S/Ü) MEKSBOX 9 LÜ		1 ad.	20	23,020
001 027 000009 00 00	W OTOMAT KUTUSU (S/A) MEKSBOX 9 LÜ		1 ad.	20	22,414
001 027 100012 00 00	W OTOMAT KUTUSU (S/Ü) MEKSBOX 12 Lİ		1 ad.	10	29,049
001 027 000012 00 00	W OTOMAT KUTUSU (S/A) MEKSBOX 12 Lİ		1 ad.	10	31,776
001 027 100016 00 00	W OTOMAT KUTUSU (S/Ü) MEKSBOX 16 Lİ		1 ad.	10	36,972
001 027 000016 00 00	W OTOMAT KUTUSU (S/A) MEKSBOX 16 Lİ		1 ad.	10	35,813
001 027 100024 00 00	W OTOMAT KUTUSU (S/Ü) MEKSBOX 24 LÜ		1 ad.	5	53,403
001 027 000024 00 00	W OTOMAT KUTUSU (S/A) MEKSBOX 24 LÜ		1 ad.	5	47,660
001 027 100036 00 00	W OTOMAT KUTUSU (S/Ü) MEKSBOX 36 Lİ		1 ad.	5	70,965
001 027 000036 00 00	W OTOMAT KUTUSU (S/A) MEKSBOX 36 Lİ		1 ad.	5	64,763

MEKSBOX W OTOMAT KUTULARI (ALEV YAYMAYAN)

CE IP30

001 027 210001 00 00	MÜH.W OTOMAT KUTUSU ALEV YAYMAYAN (S/Ü) 1 Lİ		20 ad.	160	4,798
001 027 210002 00 00	MÜH.W OTOMAT KUTUSU ALEV YAYMAYAN (S/Ü) 2 Lİ		20 ad.	80	4,986
001 027 210004 00 00	MÜH.W OTOMAT KUTUSU ALEV YAYMAYAN (S/Ü) 4 LÜ		10 ad.	80	8,099
001 027 110002 00 00	W OTOMAT KUTUSU (S/Ü) ALEV YAYMAYAN 2 Lİ		1 ad.	30	16,305
001 027 010002 00 00	W OTOMAT KUTUSU (S/A) ALEV YAYMAYAN 2 Lİ		1 ad.	30	16,000
001 027 110004 00 00	W OTOMAT KUTUSU (S/Ü) ALEV YAYMAYAN 4 LÜ		1 ad.	20	21,874
001 027 010004 00 00	W OTOMAT KUTUSU (S/A) ALEV YAYMAYAN 4 LÜ		1 ad.	20	20,769
001 027 110006 00 00	W OTOMAT KUTUSU (S/Ü) ALEV YAYMAYAN 6 Lİ		1 ad.	20	28,482
001 027 010006 00 00	W OTOMAT KUTUSU (S/A) ALEV YAYMAYAN 6 Lİ		1 ad.	20	21,464
001 027 110009 00 00	W OTOMAT KUTUSU (S/Ü) ALEV YAYMAYAN 9 LÜ		1 ad.	20	37,978
001 027 010009 00 00	W OTOMAT KUTUSU (S/A) ALEV YAYMAYAN 9 LÜ		1 ad.	20	36,193
001 027 110012 00 00	W OTOMAT KUTUSU (S/Ü) ALEV YAYMAYAN 12 Lİ		1 ad.	10	47,544
001 027 010012 00 00	W OTOMAT KUTUSU (S/A) ALEV YAYMAYAN 12 Lİ		1 ad.	10	37,613
001 027 110016 00 00	W OTOMAT KUTUSU (S/Ü) ALEV YAYMAYAN 16 Lİ		1 ad.	10	53,214
001 027 010016 00 00	W OTOMAT KUTUSU (S/A) ALEV YAYMAYAN 16 Lİ		1 ad.	10	40,414
001 027 110024 00 00	W OTOMAT KUTUSU (S/Ü) ALEV YAYMAYAN 24 LÜ		1 ad.	5	80,836
001 027 010024 00 00	W OTOMAT KUTUSU (S/A) ALEV YAYMAYAN 24 LÜ		1 ad.	5	78,491
001 027 110036 00 00	W OTOMAT KUTUSU (S/Ü) ALEV YAYMAYAN 36 Lİ		1 ad.	5	122,797
001 027 010036 00 00	W OTOMAT KUTUSU (S/A) ALEV YAYMAYAN 36 Lİ		1 ad.	5	91,566





Kod	Açıklama / Stok Cinsi	Amb. Kutu/Bağ	Amb. Koli/Çv	FİYAT
001 049 001020 00 17	TLF. DĞT. KUTUSU (10 - 20) BOŞ PLS. KLT	2 ad.	60	10,816
001 049 201020 00 17	TLF.DĞT.KUTUSU(10-20)BOŞ PLS.(KİLİTLİ) (A. YAYMAYAN)	2 ad.	60	17,892
001 049 011020 00 17	TLF. DĞT. KUTUSU (10 - 20) BOŞ KİLİTLİ	2 ad.	60	19,634
001 049 211020 00 17	TLF.DĞT.KUTUSU(10-20)BOŞ(KİLİTLİ) (A. YAYMAYAN)	2 ad.	60	27,627
001 049 001050 00 17	TLF. DĞT. KUTUSU(10-50) BOŞ PLS.KİLİT	1 ad.	28	22,493
001 049 201050 00 17	TLF.DĞT.KUTUSU(10-50)BOŞ PLS.(KİLİTLİ) (A. YAYMAYAN)	1 ad.	28	34,950
001 049 011050 00 17	TLF. DĞT. KUTUSU(10-50) KİLİTLİ	1 ad.	28	30,725
001 049 211050 00 17	TLF.DĞT.KUTUSU(10-50)(KİLİTLİ) (A. YAYMAYAN)	1 ad.	28	35,692
061 049 015012	H.TDK. (50 - 120) KİLİTLİ TİP. PER. BOŞ.	1 ad.	12	87,434
001 024 000001 00 00	ÇATI (1 MODÜL İÇİN)	1 ad.	1000	1,411
001 024 000002 00 00	ÇATI (2 MODÜL İÇİN)	1 ad.	500	2,821
001 024 000003 00 00	ÇATI (3 MODÜL İÇİN)	1 ad.	400	4,411
001 024 000004 00 00	ÇATI (4 MODÜL İÇİN)	1 ad.	300	5,893
001 024 000005 00 00	ÇATI (5 MODÜL İÇİN)	1 ad.	200	7,374
001 024 000010 00 00	ÇATI (10 MODÜL İÇİN)	1 ad.	100	14,107
888 049 050001	KESMESİZ MODÜL	10 ad.	250	2,280\$
888 049 050002	KESMELİ MODÜL	10 ad.	250	2,511\$
888 049 050003	İRTİBATLAMA ALETİ	1 ad.	50	13,097\$
031 049 040001	DAİRE İÇİ TLF.DĞT. KUTUSU (TEK JAKLI)	10 ad.	50	0,655\$
031 049 040002	DAİRE İÇİ TLF.DĞT. KUTUSU (ÇİFT JAKLI)	10 ad.	50	0,754\$
888 049 050005	TELEFON SİRİRAL KORDONU	1 ad.	100	0,897\$
888 049 050006	TELEFON KÖKEN KORDON (TEK JAKLI)	1 ad.	100	0,744\$
888 049 050007	TELEFON KÖKEN KORDON (ÇİFT JAKLI)	1 ad.	100	0,833\$
888 101 010012	DATA+TEL. SIKMA PENSESİ 8P6P	1 ad.	5	26,193\$
888 049 050011	VT4001 6P4C PLUG	100 ad.	1000	0,042\$
888 049 050010	VT4003 8P8C PLUG	100 ad.	1000	0,088\$
888 049 050016	VT4006 4P4C SPRAL KORUYUCU (FIRDÖNDÜ)	1 ad.	100	1,670\$

DUYLAR

040 109 040002	İTALYAN DUY E 27	50 ad.		2,216
040 109 040001	İTALYAN DUY E 14	100 ad.		2,074
040 109 040005	İTALYAN DUY RONDELASI E27	100 ad.		0,682
040 109 040003	İTALYAN DUY RONDELASI E14	100 ad.		0,568
040 109 030004	MİSFER E 27 BRONZ DUY	50 ad.		5,682
040 109 030003	MİSFER E 14 BRONZ DUY	100 ad.		5,398
024 109 010008	BAKALİT ASMA DUY	50 ad.		1,875
072 109 010001	DUVAR DUY	50 ad.		2,131
072 109 010002	TAVAN DUY	50 ad.		2,131
024 109 010004	TAVAN GLOP DİBİ	24 ad.		2,841
024 109 010003	DUVAR GLOP DİBİ	24 ad.		2,841
024 109 010005	YAĞMUR DUY	50 ad.		1,964

FLORESANT SÖKETLER

004 078 000003	TMS STARTER YUVASI (GEÇMELİ)	100 ad.		0,597
001 078 010004 00 00	FLORESANT TUTUCU AY AYAK (VİDALI TİP)	250 ad.		0,135

FİŞ ÇEŞİTLERİ

001 888 000001 00 00	PRİZMATİK ÇOCUK KORUMA KAPAĞI	100 ad.		2,310
999 999 000186	2 MT. KABLOLU BASKILI TEYP FİŞİ	1 ad.		5,313
024 109 060001	DUY FİŞ PERÇİNLİ	50 ad.		2,216
024 109 060002	DUY PRİZ	50 ad.		5,818
031 114 020005	TV ERKEK FİŞ	100 ad.		0,909
031 114 020006	TV DIŞI FİŞ	100 ad.		0,909
031 114 000050	OK-050 F KONNEKTÖR RG-6	100 ad.		0,568
031 114 000051	OK-051 F KONNEKTÖR RG-59	100 ad.		0,597
031 114 000057	OK-057 F ARA KONNEKTÖR	100 ad.		0,824
031 114 000062	OK-062İ 3RCA-3RCA ARA KABLO	1 ad.		2,446\$
031 114 000065	OK-065İ SCART-3RCA ARA KABLO (IN)	1 ad.		1,951\$
031 114 000063	OK-063İ SCART-SCART ARA KABLO	1 ad.		2,112\$
031 114 000088	OK-88İ JAKLI TELEFON FİŞİ	50 ad.		0,978\$
031 114 000082	OK-082İ 6P4C DIŞI ARA ADAPTÖR	1 ad.		5,443\$

Kod	Açıklama / Stok Cinsi	Amb. Kutu/Bağ	Amb. Koli/Çyl	FİYAT
MUTLUSAN KONTROL KALEMLERİ				
104 119 000001	JUMBO DÜZ KONTROL KALEMİ	12 ad.		2,060
104 119 000002	JUMBO YILDIZ KONTROL KALEMİ	12 ad.		2,273
104 119 000003	KOMBO DÜZ KONTROL KALEMİ	12 ad.		2,273
104 119 000004	KOMBO YILDIZ KONTROL KALEMİ	12 ad.		2,557
104 119 500001	LÜX DÜZ KONTROL KALEMİ	12 ad.		7,441
104 119 500002	LÜX YILDIZ KONTROL KALEMİ	12 ad.		8,929

VIP-TEC KOMBİNE PENSELER

105 101 210160	VT210160 VIP-TEC KOMBİNE PENSE 160MM	6 ad.		58,071
105 101 210180	VT210180 VIP-TEC KOMBİNE PENSE 180MM	6 ad.		66,852
105 101 210200	VT210200 VIP-TEC KOMBİNE PENSE 200MM	6 ad.		78,043
105 101 215160	VT215160 VIP-TEC YAN KESKİ 160MM	6 ad.		59,648
105 101 215180	VT215180 VIP-TEC YAN KESKİ 180MM	6 ad.		69,590
105 101 200160	VT200160 VIP-TEC PLATINIUM KOMBİNE PENSE 160MM	6 ad.		67,893
105 101 200180	VT200180 VIP-TEC PLATINIUM KOMBİNE PENSE 180MM	6 ad.		73,221
105 101 201160	VT201160 VIP-TEC PLATINIUM YAN KESKİ 160MM	6 ad.		67,864
105 101 201180	VT201180 VIP-TEC PLATINIUM YAN KESKİ 180MM	6 ad.		73,310
105 119 210309	VT210309 VIP-TEC MULTIBAG TORN.-PENSE TAKIMI (9 PRÇ)	1 ad.		269,519
105 119 200309	VT200309 VIP-TEC MULTIBAG TORN.-PENSE TAKIMI (9 PRÇ)	1 ad.		324,525

VIP-TEC TORNAVİDALAR

105 101 610031	VT6100/31 VIP-TEC DÜZ UÇLU TORNAVİDA 3.0X75MM	12 ad.		6,310
105 101 610042	VT6100/42 VIP-TEC DÜZ UÇLU TORNAVİDA 4.0X100MM	12 ad.		10,686
105 101 610052	VT6100/52 VIP-TEC DÜZ UÇLU TORNAVİDA 5.5X100MM	12 ad.		12,382
105 101 610063	VT6100/63 VIP-TEC DÜZ UÇLU TORNAVİDA 6.5X125MM	12 ad.		15,686
105 101 620031	VT6200/31 VIP-TEC YILDIZ UÇLU TORNAVİDA PH0X75MM	12 ad.		6,965
105 101 620042	VT6200/42 VIP-TEC YILDIZ UÇLU TORNAVİDA PH1X100MM	12 ad.		10,656
105 101 620062	VT6200/62 VIP-TEC YILDIZ UÇLU TORNAVİDA PH2X100MM	12 ad.		13,692
105 101 620063	VT6200/63 VIP-TEC YILDIZ UÇLU TORNAVİDA PH2X125MM	12 ad.		15,329
105 101 607000	VT6000/7ST1 VIP-TEC ART TORNAVİDA SETİ (7 PRÇ)	1 ad.		82,984
105 119 006190	VT6190 VIP-TEC DÜZ UÇLU KONTROL KALEMİ 3.5MM	24 ad.		11,251
105 119 006191	VT6191 VIP-TEC YILDIZ UÇLU KONTROL KALEMİ PH0	24 ad.		11,251
105 119 006192	VT6192 VIP-TEC CEP KONTROL KALEMİ 4.0MM	24 ad.		10,507
105 119 006193	VT6193 VIP-TEC DÜZ UÇLU KONTROL KALEMİ 3.5MM	24 ad.		11,638

VIPTEC 1000V İZOLELİ ALETLER

105 101 201309	VT201309 VIP-TEC 1000V İZOLELİ PENSE-TORN. ÇANTA (9 PRÇ)	1 ad.		386,882
105 101 201310	VT201310 VIP-TEC 1000V İZOLELİ PENSE-TORN. ÇANTA (10 PRÇ)	1 ad.		598,955
105 101 210318	VT210318 VIP-TEC MULTIBAG JUMBO TAKIM (9 PRÇ)	1 ad.		649,049
105 101 810032	VT8100/32 VIP-TEC 1000V İZOLELİ DÜZ UÇLU TORN. 3.0X100MM	12 ad.		12,977
105 101 810042	VT8100/42 VIP-TEC 1000V İZOLELİ DÜZ UÇLU TORN. 4.0X100MM	12 ad.		17,412
105 101 810053	VT8100/53 VIP-TEC 1000V İZOLELİ DÜZ UÇLU TORN. 5.5X125MM	12 ad.		20,180
105 101 810064	VT8100/64 VIP-TEC 1000V İZOLELİ DÜZ UÇLU TORN. 6.5X125MM	12 ad.		24,467
105 101 820030	VT8200/30 VIP-TEC 1000V İZOLELİ YILDIZ UÇLU TORN. PH0X60MM	12 ad.		12,114
105 101 820041	VT8200/41 VIP-TEC 1000V İZOLELİ YILDIZ UÇLU TORN. PH1X80MM	12 ad.		16,222
105 101 820062	VT8200/62 VIP-TEC 1000V İZOLELİ YILDIZ UÇLU TORN. PH2X100MM	12 ad.		21,044
105 101 820084	VT8200/84 VIP-TEC 1000V İZOLELİ YILDIZ UÇLU TORN. PH3X150MM	12 ad.		32,086
105 101 205160	VT205160 VIP-TEC 1000V İZOLELİ KOMBİNE PENSE 160MM	6 ad.		77,091
105 101 205180	VT205180 VIP-TEC 1000V İZOLELİ KOMBİNE PENSE 180MM	6 ad.		81,615
105 101 206160	VT206160 VIP-TEC 1000V İZOLELİ YAN KESKİ 160MM	6 ad.		77,091
105 101 206180	VT206180 VIP-TEC 1000V İZOLELİ YAN KESKİ 180MM	6 ad.		79,948
105 101 208160	VT208160 VIP-TEC 1000V İZOLELİ EĞRİ KARGABURNU 160MM	6 ad.		70,780

VIPTEC METAL TAKIM ÇANTASI

105 101 105051	VT895105D-51 ELEKTRİKÇİ TİP METAL TAKIM ÇANTASI (51 PRÇ)	1 ad.		1,314,618
----------------	--	-------	--	-----------

JOKARİ KABLO SİYIRMA VE KESME İÇİN EV ALETLERİ

129 087 000351	10160 4-16MM TÜM YUVARLAK KABLO KILIFLARINI SOYMAK İÇİN	1 ad.		19,310 €
129 087 000355	10282 8-28MM TÜM YUVARLAK KABLO KILIFLARINI SOYMAK İÇİN	1 ad.		19,310 €
129 087 000356	10350 27-35MM TÜM YUVARLAK KABLO KILIFLARINI SOYMAK İÇİN	1 ad.		30,155 €
129 087 000359	20050 MAX.2,5MMYE KADAR OLAN İLETKENLER İÇİN,UZUNLUK STOPU 6-15MM ARASI AYARLANABİLİR.	1 ad.		27,444 €

KONTROL KALEMLERİ (İTHAL)

888 119 010003	FHT-159 VOL.TEST K.KALEMİAC/DC 100-250V	12 ad.		0,828 \$
888 119 010007	FHT-608 VOL.TEST K.KALEMİAC/DC 100-250V	12 ad.		1,663 \$
888 119 010006	FHT-304C VOL.TEST K.KALEMİAC/DC 100-250V	12 ad.		0,656 \$
888 119 010010	FHT-2006 VOL.TEST K.KAL.AC 110/220/380V	10 ad.		3,219 \$
888 119 010011	FHT-9818 VOLTAJ TEST KONTROL KALEMİ	25 ad.		2,241 \$
888 119 010001	FHT-023 KONTROL KALEMİ TAKIM KUTUSU	1 ad.		1,719 \$
888 119 010004	FHT-232 VOL.TEST K.KALEMİAC/DC 100-250V	20 ad.		1,250 \$
888 119 010005	FHT-233 VOL.TEST K.KALEMİAC/DC 100-250V	20 ad.		1,219 \$
888 119 010009	FHT-828R DJJ.VOLT.TEST.12,36,55,110,220V	50 ad.		1,622 \$
888 119 010014	FHT-611 İNCE TİP KONT.KALEMİ YILDIZ AC/DC 100-500V	1 ad.		0,875 \$
888 119 010015	FHT-602 KALIN TİP KONT.KALEMİ DÜZ AC/DC 100-500V	1 ad.		0,938 \$
888 119 010016	FHT-612 KALIN TİP KONT.KALEMİ YILDIZ AC/DC 100-500V	1 ad.		0,938 \$
888 119 010018	FHT-958 KOPIK HAT DEDEKTÖRÜ	1 ad.		6,147 \$

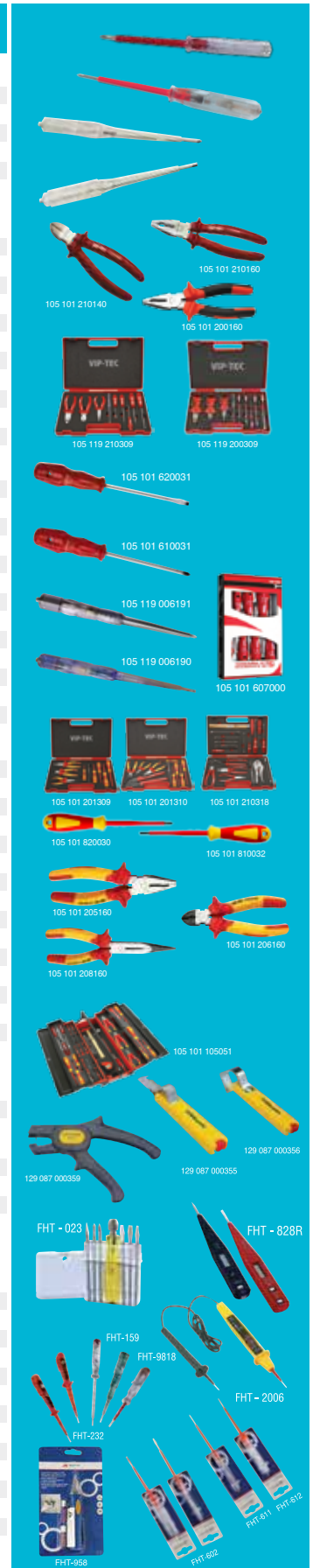



Kod	Açıklama / Stok Cinsi	Amb. (Kutu/Bağ)	Amb. (Koli/Çv.)	FİYAT	
MUTLUSAN BETON ÇİVİLİ KROŞELER					
032 048 070000	NO:0 BETON ÇİVİLİ KROŞE(0.75 YASSIKORD.)	MUTLUSAN	1000ad.	30000	0,027
032 048 070001	NO:1 BETON ÇİVİLİ KROŞE(0.75 YASSIKORD.)	MUTLUSAN	1000ad.	30000	0,027
032 048 070002	NO:2 BETON ÇİVİLİ KROŞE(0.75 YASSIKORD.)	MUTLUSAN	1000ad.	20000	0,027
032 048 070003	NO:3 BETON ÇİVİLİ KROŞE (2X1.5-3X1.5)	MUTLUSAN	1000ad.	20000	0,037
032 048 070004	NO:4 BETON ÇİVİLİ KROŞE (2X4)	MUTLUSAN	1000ad.	20000	0,037
032 048 070005	NO:5 BETON ÇİVİLİ KROŞE (2X4-4X4)	MUTLUSAN	1000ad.	10000	0,051
032 048 070006	NO:6 BETON ÇİVİLİ KROŞE (2X6)	MUTLUSAN	1000ad.	10000	0,051
032 048 070007	NO:7 BETON ÇİVİLİ KROŞE (4X10)	MUTLUSAN	1000ad.	8000	0,111
032 048 070008	NO:8 BETON ÇİVİLİ KROŞE (3X16+10)	MUTLUSAN	600ad.	5000	0,139
032 048 070009	NO:9 BETON ÇİVİLİ KROŞE (3X25+16)	MUTLUSAN	500ad.		0,145
BETON ÇİVİLİ KROŞELER (GÖÇMEN)					
032 048 080000	NO:0 BETON ÇİVİLİ KROŞE(0.75 YASSIKORD.)	GÖÇMEN	1000ad.	40000	0,032
032 048 080001	NO:1 BETON ÇİVİLİ KROŞE(0.75 YASSIKORD.)	GÖÇMEN	1000ad.	40000	0,032
032 048 080002	NO:2 BETON ÇİVİLİ KROŞE(0.75 YASSIKORD.)	GÖÇMEN	1000ad.	40000	0,032
032 048 080003	NO:3 BETON ÇİVİLİ KROŞE (2X1.5-3X1.5)	GÖÇMEN	1000ad.	24000	0,043
032 048 080004	NO:4 BETON ÇİVİLİ KROŞE (2X4)	GÖÇMEN	1000ad.	24000	0,043
032 048 080005	NO:5 BETON ÇİVİLİ KROŞE (2X4-4X4)	GÖÇMEN	1000ad.	20000	0,055
032 048 080006	NO:6 BETON ÇİVİLİ KROŞE (2X6)	GÖÇMEN	1000ad.	18000	0,055
032 048 080007	NO:7 BETON ÇİVİLİ KROŞE (4X10)	GÖÇMEN	800 ad.	10000	0,114
032 048 080008	NO:8 BETON ÇİVİLİ KROŞE (3X16+10)	GÖÇMEN	400 ad.	4800	0,170
032 048 080009	NO:9 BETON ÇİVİLİ KROŞE (3X25+16)	GÖÇMEN	400 ad.	4800	0,216
ANTİGRON KROŞELER					
128 048 000001	NO:1 ANT. KROŞE(2X1.5-2X2.5-3X1.5-3X2.5)		100 ad.	3000	0,196
128 048 000015	NO:1.5 ANTİGRON KROŞE (2X4-2X6-4X4-4X6)		100 ad.	2000	0,214
128 048 000002	NO:2 ANTİGRON KROŞELER (4X10)		100 ad.	1500	0,327
128 048 000003	NO:3 ANTİGRON KROŞELER (4X16-3X25+16)		50 ad.	800	0,491
GALVANİZLİ SAÇ KROŞELER					
001 048 060001 00 00	NO. 1 TEKLİ GALVANİZ SAÇ KROŞE 12MM		1500ad.		0,111
001 048 060002 00 00	NO. 2 TEKLİ GALVANİZ SAÇ KROŞE 14MM		1000ad.		0,104
001 048 060003 00 00	NO. 3 TEKLİ GALVANİZ SAÇ KROŞE 17MM		700ad.		0,134
001 048 060004 00 00	NO. 4 TEKLİ GALVANİZ SAÇ KROŞE 20MM		500ad.		0,161
001 048 060007 00 00	NO. 7 TEKLİ GALVANİZ SAÇ KROŞE 26MM		350ad.		0,213
001 048 060008 00 00	NO. 8 TEKLİ GALVANİZ SAÇ KROŞE 34MM		250ad.		0,320
001 048 060009 00 00	NO. 9 TEKLİ GALVANİZ SAÇ KROŞE 43MM		200ad.		0,435
001 048 060010 00 00	NO. 10 TEKLİ GALVANİZ SAÇ KROŞE 53MM		150ad.		0,499
001 048 060011 00 00	NO. 11 TEKLİ GALVANİZ SAÇ KROŞE 55MM		120ad.		0,592
001 048 070002 00 00	NO. 2 ÇİFTLİ GALVANİZ SAÇ KROŞE 13MM		600ad.		0,143
001 048 070003 00 00	NO. 3 ÇİFTLİ GALVANİZ SAÇ KROŞE 16MM		500ad.		0,170
001 048 070004 00 00	NO. 4 ÇİFTLİ GALVANİZ SAÇ KROŞE 22MM		400ad.		0,183
001 048 070007 00 00	NO. 7 ÇİFTLİ GALVANİZ SAÇ KROŞE 25MM		400ad.		0,229
001 048 070008 00 00	NO. 8 ÇİFTLİ GALVANİZ SAÇ KROŞE 35MM		300ad.		0,316
001 048 070009 00 00	NO. 9 ÇİFTLİ GALVANİZ SAÇ KROŞE 45MM		200ad.		0,395
001 048 070010 00 00	NO. 10 ÇİFTLİ GALVANİZ SAÇ KROŞE 50MM		150ad.		0,462
001 048 070011 00 00	NO. 11 ÇİFTLİ GALVANİZ SAÇ KROŞE 55MM		100ad.		0,720
RAY KROŞE VE TANDIR KROŞELER					
035 048 100001	NO. 1 RAY KROŞE (2X1.5-4X2.5)		350 ad.		0,469
035 048 100002	NO. 2 RAY KROŞE (4X4-4X16)		250 ad.		0,461
001 025 010100 00 00	GALVANİZ KROŞE RAYI (1M)		50 ad.		4,935
035 048 110001	NO. 1 TANDIR KROŞE (2X1.5-2X6)		350 ad.		0,393
035 048 110002	NO. 2 TANDIR KROŞE (4X6)		250 ad.		0,393
035 048 110003	NO. 3 TANDIR KROŞE (4X10)		250 ad.		0,393
035 048 110004	NO. 4 TANDIR KROŞE (4X16)		150 ad.		0,485
035 048 110005	NO. 5 TANDIR KROŞE (3X25+16)		150 ad.		0,485

Kod	Açıklama / Stok Cinsi	Amb. Kutu/Bağ	Amb. Koli/Çi	FİYAT
PLASTİK DÜBELLER				
016 053 000014	BURGULU ALÇIBAN DÜBELİ (YENİ)	100 ad.	10000	0,101
016 053 308100	8X100MM BOŞLUK DÜBELİ	100 ad.	10000	0,129
001 053 000001 00 00	ALÇIPAN DÜBEL	100 ad.	15000	0,137
016 053 100002	MEGA DÜBEL	1000ad.	14000	0,075
001 053 000002 00 00	KANAL DÜBELİ	1000ad.	14000	0,069
888 129 080185	DÜBELLİ KABLO BAĞI 8X18,5	100 ad.	1700	0,209
001 053 000005 00 00	KORNIŞ DÜBELİ	1000ad.	14000	0,095
016 053 000006	6 MM BEYAZ DÜBEL	1000ad.	35000	0,021
016 053 000007	7 MM BEYAZ DÜBEL	1000ad.	25000	0,022
016 053 000008	8 MM BEYAZ DÜBEL	1000ad.	20000	0,025
016 053 000010	10 MM BEYAZ DÜBEL	1000ad.	10000	0,058
016 053 000012	12 MM BEYAZ DÜBEL	250 ad.	2500	0,206
016 053 000106	6 MM RENKLİ DÜBEL (YEŞİL)	1000ad.	35000	0,021
016 053 000107	7 MM RENKLİ DÜBEL (SARI)	1000ad.	25000	0,024
016 053 000108	8 MM RENKLİ DÜBEL (KIRMIZI)	1000ad.	10000	0,026
016 053 000110	10 MM RENKLİ DÜBEL (MAVİ)	1000ad.	10000	0,055
016 053 300008	8 MM ROKET DÜBEL	1000ad.	20000	0,070
016 053 300010	10 MM ROKET DÜBEL	500 ad.	10000	0,105

DÜBELLİ KROŞELER

001 048 090002 00 17	3/13 TEKLİ KABLO KROŞESİ	500 ad.	10000	0,044
001 048 090006 00 17	8/28 TEKLİ KABLO KROŞESİ	500 ad.	5000	0,064
001 048 090001 00 00	ÇİFTLİ KABLO KROŞESİ	100 ad.	2500	0,071
001 048 090003 00 17	16'LİK BORU KELEPÇESİ	100 ad.	2000	0,106
001 048 090004 00 17	20'LİK BORU KELEPÇESİ	100 ad.	1500	0,129
001 048 090005 00 17	25'LİK BORU KELEPÇESİ	100 ad.	1000	0,169

KANCA VİDALAR

013 099 031860	18X60 KANCA VİDA	1 grs.	144	25,181
013 099 031960	19X60 KANCA VİDA	1 grs.	144	32,533
013 099 031970	19X70 KANCA VİDA	1 grs.	144	34,081
013 099 032060	20X60 KANCA VİDA	1 grs.	144	36,075
013 099 032070	20X70 KANCA VİDA	1 grs.	144	37,504
013 099 032080	20X80 KANCA VİDA	1 grs.	100	26,878
013 099 032180	21X80 KANCA VİDA	1 grs.	100	30,420
013 099 021100	21X100 KANCA VİDA	1 grs.	50	17,710

YILDIZ BAŞLI AĞAÇ VİDALARI

013 099 012030	20X30 VİDA YILDIZ BAŞLI	1 grs.	12 grs.	9,912
013 099 012035	20X35 VİDA YILDIZ BAŞLI	1 grs.	12 grs.	10,983
013 099 012040	20X40 VİDA YILDIZ BAŞLI	1 grs.	12 grs.	12,025
013 099 012045	20X45 VİDA YILDIZ BAŞLI	1 grs.	12 grs.	13,394
013 099 012050	20X50 VİDA YILDIZ BAŞLI	1 grs.	12 grs.	14,376
013 099 012060	20X60 VİDA YILDIZ BAŞLI	1 grs.	12 grs.	16,966

SUNTA VİDASI ÇİNKO KAPLAMA

013 099 043535	3,5X35 SUNTA VİDASI (1000 ADET FİYATI)	1 grs.		56,315
013 099 043540	3,5X40 SUNTA VİDASI (500 ADET FİYATI)	1 grs.		30,777
013 099 040425	4X25 SUNTA VİDASI (500 ADET FİYATI)	1 grs.		28,276
013 099 040430	4X30 SUNTA VİDASI (500 ADET FİYATI)	1 grs.		32,146
013 099 040435	4X35 SUNTA VİDASI (500 ADET FİYATI)	1 grs.		35,122
013 099 040440	4X40 SUNTA VİDASI (500 ADET FİYAT)	1 grs.		39,885
013 099 040445	4X45 SUNTA VİDASI (500ADET FİYAT)	1 grs.		42,266
013 099 040460	4X60 SUNTA VİDASI (200 ADET FİYATI)	1 grs.		21,222
013 099 040450	4X50 SUNTA VİDASI (450 ADET FİYATI)	1 grs.		42,301
013 099 044460	4,5X60 SUNTA VİDASI (200 ADET FİYATI)	1 grs.		26,193
013 099 044530	4,5X30 SUNTA VİDASI (500 ADET FİYATI)	1 grs.		50,094
013 099 044535	4,5X35 SUNTA VİDASI (200 ADET FİYATI)	1 grs.		17,710
013 099 044540	4,5X40 SUNTA VİDASI (200 ADET FİYATI)	1 grs.		19,109
013 099 044545	4,5X45 SUNTA VİDASI (200 ADET FİYATI)	1 grs.		20,657
013 099 044550	4,5X50 SUNTA VİDASI (200 ADET FİYATI)	1 grs.		22,919
013 099 040530	5X30 SUNTA VİDASI (200 ADET FİYATI)	1 grs.		18,246
013 099 040535	5X35 SUNTA VİDASI (200 ADET FİYATI)	1 grs.		22,175
013 099 040540	5X40 SUNTA VİDASI (200 ADET FİYATI)	1 grs.		23,336
013 099 040545	5X45 SUNTA VİDASI (200 ADET FİYATI)	1 grs.		26,193
013 099 040550	5X50 SUNTA VİDASI (200 ADET FİYATI)	1 grs.		30,062
013 099 040560	5X60 SUNTA VİDASI (200 ADET FİYATI)	1 grs.		32,086

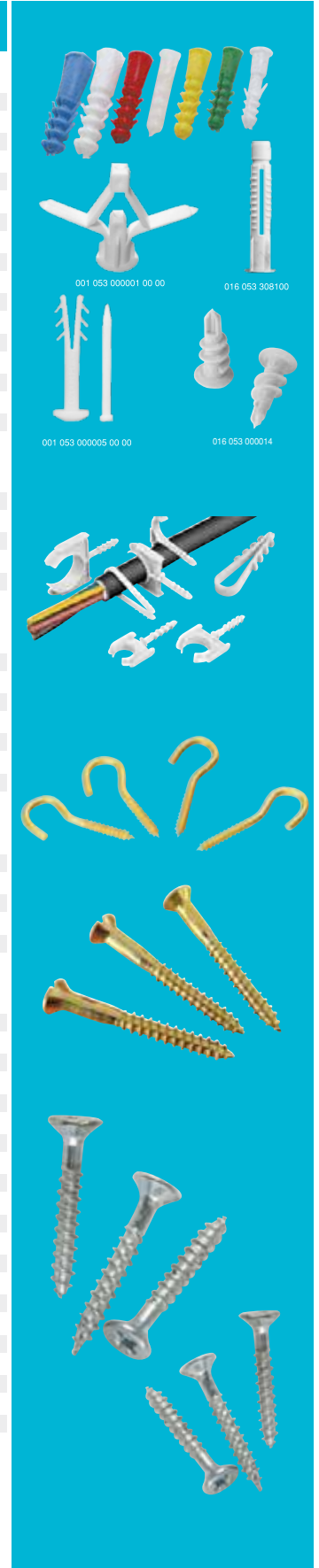



Kod	Açıklama / Stok Cinsi	Amb. (Kutu/Bag)	Amb. (Koli/Çv.)	FİYAT
-----	-----------------------	-----------------	-----------------	-------

GEÇMELİ BUAT KLEMENSLERİ

888 094 260802	BM802 GEÇMELİ BUAT KLEMENSİ (2'Lİ)	400	6400	0,680
888 094 260803	BM803 GEÇMELİ BUAT KLEMENSİ (3'Lİ)	300	4800	0,760
888 094 260804	BM804 GEÇMELİ BUAT KLEMENSİ (4'Lİ)	200	3200	0,944
888 094 260805	BM805 GEÇMELİ BUAT KLEMENSİ (5'Lİ)	200	3200	1,024
015 094 160001	NO. 2 ZEYTİN (BUAT) KLEMENS	1000	5000	0,104

ŞEFFAF İSİYA DAYANIKLI BUAT KLEMENSLER

888 094 000105	NO.2 ŞEFFAF BUAT KLEMENS (1 ADET FİYAT)	560	ad.	0,506
888 094 000205	NO.3 ŞEFFAF BUAT KLEMENS (1 ADET FİYAT)	420	ad.	0,744
888 094 000405	NO.4 ŞEFFAF BUAT KLEMENS (1 ADET FİYAT)	300	ad.	1,191
888 094 000605	NO.5 ŞEFFAF BUAT KLEMENS (1 ADET FİYAT)	160	ad.	1,339

WAGO

BUAT KLEMENSLERİ

€€

999 094 280225	2X2.5 MM WAGO BUAT KLEMENSİ	1000	ad.	0,850
999 094 280325	3X2.5 MM WAGO BUAT KLEMENSİ	1000	ad.	0,950
999 094 280425	4X2.5 MM WAGO BUAT KLEMENSİ	1000	ad.	1,180
999 094 280525	5X2.5 MM WAGO BUAT KLEMENSİ	1000	ad.	1,280
999 094 280825	8X2.5 MM WAGO BUAT KLEMENSİ	500	ad.	2,830

WAGO

KOMPAKT ÇOK AMAÇLI KLEMENS

€€

999 094 300412	221-412 İKİLİ ÇOK AMAÇLI KOMPAKT KLEMENS	1000	ad.	2,040
999 094 300413	221-413 ÜÇLÜ ÇOK AMAÇLI KOMPAKT KLEMENS	500	ad.	2,600
999 094 300415	221-415 BEŞLİ ÇOK AMAÇLI KOMPAKT KLEMENS	250	ad.	4,140

- Nominal akım: 32 A
- Nominal gerilim: 450 V
- Yüksek sıcaklıklar için:
- Sürekli çalışma sıcaklığı: maks. 105 °C
- Ortam sıcaklığı: maks. 85 °C (T85)

- 0.14-4 mm²
(24-12 AWG)
- 0.2-4 mm²
(24-12 AWG)



**Tornavida
Yok
+ Tüm kablo
Tipleri için
+ 100%
Güvenli**



WAGO ÖLÇÜM ALETLERİ



KOD: : 999 094 310810
ÜRÜN ADI : 206-810 MULTİMETRE
FİYAT : 206,269 EURO

- AC-DC True-RMS
- Data-Hold Fonksiyonu, diyet test fonksiyonu, buzzer
- 0,01 A -60/600 DC A aralığı seçimi
- 0,01 A -600 AC A aralığı seçimi 40-400Hz arası
- 600mV 600V AC/DC 40-400Hz arası ölçüm seçimi
- Frekans ölçümü Clamp ile 600Hz - 1KHz(>1A)
- Frekans ölçümü Prob ile 600Hz - 10KHz
- 60 Megaohm a kadar direnç, 60mF a kadar kapasite ölçümü
- 4 Dijit LCD Ekran ve otomatik kapanma fonksiyonu
- LED Lamba ile aydınlanma
- CAT III 600 V ve IP44
- TÜV/GS onaylı, EC/EN 61010-1 (DIN VDE 0411)
- 5 YIL GARANTİ



KOD: : 999 094 310315
ÜRÜN ADI : 206-315 CLAMP AMPER METRE
FİYAT : 202,192 EURO

- AC-DC True-RMS Akım ölçümü
- Data-Hold Fonksiyonu
- Max. kablı çapı ø 21 mm
- Dar alanlarda rahat kullanım için küçük boyutlar
- 0,01 A -40 A aralığı seçim yada
- 0,1 A -200 A aralığı seçim
- Saniyede 3 kez deger yenileme
- Otomatik kapanma fonksiyonu
- CAT III 300 V ve IP44
- TÜV/GS onaylı
- IEC/EN 61010-1 (DIN VDE 0411)
- 5 YIL GARANTİ



KOD: : 999 094 310816
ÜRÜN ADI : 06-816 CLAMP AMPER METRE
FİYAT : 318,780 EURO

- AC-DC True-RMS Akım/Gerilim ölçümlü multimetre
- Data-Hold Fonksiyonu, diyet test fonksiyonu, buzzer
- 0,01 A -60/600 DC A aralığı seçimi
- 0,01 A -600 AC A aralığı seçimi 40 -400Hz arası
- 600mV -600V AC/DC 40 -400Hz arası ölçüm seçimi
- Frekans ölçümü Clamp ile 600Hz - 1KHz (>1A)
- Frekans ölçümü Prob ile 600Hz - 10KHz
- 60 Megaohm a kadar direnç, 60mF a kadar kapasitör ölçümü
- 4 Dijit LCD Ekran ve otomatik kapanma fonksiyonu
- LED lamba ile aydınlatma
- CAT III 600 V ve IP44
- TÜV/GS onaylı, IEC/EN 61010-1 (DIN VDE 0411)
- 5 YIL GARANTİ



KOD: : 999 094 310806
ÜRÜN ADI : 206-806 LED GÖSTERGELİ VOLT M.
FİYAT : 114,743 EURO

- IP65 su ve tozdan koruma
- 6-1000 VAC/DC otomatik gösterim
- AC>100 V gerilimi temassız tespit
- 2 kutup (R-L) faz sırası testi ve faz gösterimi
- 2000 Ω a kadar ölçüm ve Buzzer test
- SCHUKO ve CEE prizler için tek el kullanımı
- LED Lamba özelliği ve otomatik arka plan ışığı
- 35V üzeri hayatli gerilimlerde sesli uyarı
- Otomatik kapanma fonksiyonu
- CAT IV 1000 V, IEC/EN 61243-3
- TÜV/GS onaylı
- 5 YIL GARANTİ



KOD: : 999 094 310807
ÜRÜN ADI : 206-807 PROFİ LCD PLUS
FİYAT : 181,684 EURO

- LCD ekranlı
- IP65 su ve tozdan koruma
- 6-1000 VAC/DC otomatik gösterim
- AC>100 V gerilimi temassız tespit
- 2 kutup (R-L) faz sırası testi ve faz gösterimi
- 2000 Ω a kadar ölçüm ve Buzzer test
- SCHUKO ve CEE prizler için tek el kullanımı
- LED Lamba özelliği ve otomatik arka plan ışığı
- 35V üzeri hayatli gerilimlerde sesli uyarı
- Otomatik kapanma fonksiyonu
- CAT IV 1000 V, IEC/EN 61243-3
- TÜV/GS onaylı
- 5 YIL GARANTİ



KOD: : 999 094 310804
ÜRÜN ADI : 206-804 TEST BOY
FİYAT : 53,279 EURO

- Elektrik olan kabloların, prizlerin, arızalı ampullerin tespiti için ideal
- 12-1000 VAC arası tespit
- IP44 ABS Plastik
- CAT III 1000V, IEC/EN 61010-1
- 45 gr ağırlık
- Sesli ve görsel uyarı
- LED fener özelliği
- 2xAAA pil ile çalışır
- 5 YIL GARANTİ

Kod	Açıklama / Stok Cinsi	Amb. Kutu/Bağ	Amb. Koli/Çif	FİYAT
GEÇMELİ SOKET KLEMENS				
999 999 991212	12'LI GEÇMELİ SOKET KLEMENS	25 ad.		15,775
METAL ÜZERİ BAKIR VE NİKEL KAPLAMALI SIRA KLEMENSLER				
015 094 153001	NO. 1 NİKEL KAPLAMA SIRA KLEMENSLER SİYAH (2.5-4 MM2)	50 ad.	1000	1,989
015 094 153002	NO. 2 NİKEL KAPLAMA SIRA KLEMENSLER SİYAH (4-6 MM2)	50 ad.	1000	2,415
015 094 153003	NO. 3 NİKEL KAPLAMA SIRA KLEMENSLER SİYAH (6-10 MM2)	50 ad.	400	3,836
015 094 153004	NO. 4 NİKEL KAPLAMA SIRA KLEMENSLER SİYAH (10-16 MM2)	50 ad.	400	4,262
YANMAZ (v2) METAL ÜZERİ BAKIR VE NİKEL KAPLAMALI SIRA KLEMENSLER				
015 094 173001	NO. 1 YANMAZ (v2) NİKEL KAPLAMA KLEMENSLER ŞEFFAF (2.5-4 MM2)	50 ad.	1000	2,273
015 094 173002	NO. 2 YANMAZ (v2) NİKEL KAPLAMA KLEMENSLER ŞEFFAF (4-6 MM2)	50 ad.	1000	3,125
015 094 173003	NO. 3 YANMAZ (v2) NİKEL KAPLAMA KLEMENSLER ŞEFFAF (6-10 MM2)	50 ad.	400	4,262
015 094 173004	NO. 4 YANMAZ (v2) NİKEL KAPLAMA KLEMENSLER ŞEFFAF (10-16 MM2)	50 ad.	400	5,114
ALEV ALMAZ (v0) METAL ÜZERİ BAKIR VE NİKEL KAPLAMALI SIRA KLEMENSLER				
015 094 174001	NO. 1 ALEV ALMAZ (v0) NİKEL KAPLAMA KLEMENSLER KAHVERENGİ (2.5-4 MM2)	50 ad.	1000	2,557
015 094 174002	NO. 2 ALEV ALMAZ (v0) NİKEL KAPLAMA KLEMENSLER KAHVERENGİ (4-6 MM2)	50 ad.	1000	3,551
015 094 174003	NO. 3 ALEV ALMAZ (v0) NİKEL KAPLAMA KLEMENSLER KAHVERENGİ (6-10 MM2)	50 ad.	400	4,688
015 094 174004	NO. 4 ALEV ALMAZ (v0) NİKEL KAPLAMA KLEMENSLER KAHVERENGİ (10-16 MM2)	50 ad.	400	5,540
EKO SERİSİ PLASTİK SIRA KLEMENSLER				
015 094 151001	NO. 1 SIRA KLEMENSLER (EKO) (2.5-4 MM2)	50 ad.	1000	2,232
015 094 151002	NO. 2 SIRA KLEMENSLER (EKO) (4-6 MM2)	50 ad.	800	2,619
015 094 151003	NO. 3 SIRA KLEMENSLER (EKO) (6-10 MM2)	50 ad.	500	2,976
015 094 151004	NO. 4 SIRA KLEMENSLER (EKO) (10-16 MM2)	50 ad.	500	3,423
015 094 151005	NO. 5 SIRA KLEMENSLER (EKO) (16-25 MM2)	50 ad.	500	4,465
EKO SERİSİ ISIYA DAYANIKLI PLASTİK SIRA KLEMENSLER				
015 094 171001	NO. 1 ISIYA DAYANIKLI KLEMENSLER (EKO) (2.5-4 MM2)	50 ad.	1000	2,679
015 094 171002	NO. 2 ISIYA DAYANIKLI KLEMENSLER (EKO) (4-6 MM2)	50 ad.	800	2,976
015 094 171003	NO. 3 ISIYA DAYANIKLI KLEMENSLER (EKO) (6-10 MM2)	50 ad.	500	3,423
015 094 171004	NO. 4 ISIYA DAYANIKLI KLEMENSLER (EKO) (10-16 MM2)	50 ad.	500	3,869
015 094 171005	NO. 5 ISIYA DAYANIKLI KLEMENSLER (EKO) (16-25 MM2)	50 ad.	500	5,209
PLASTİK SIRA KLEMENSLER				
015 094 150001	NO. 1 SIRA KLEMENSLER (2.5-4 MM2)	50 ad.	1000	2,590
015 094 150002	NO. 2 SIRA KLEMENSLER (4-6 MM2)	50 ad.	800	3,125
015 094 150003	NO. 3 SIRA KLEMENSLER (6-10 MM2)	50 ad.	500	4,256
015 094 150004	NO. 4 SIRA KLEMENSLER (10-16 MM2)	50 ad.	500	4,792
015 094 150005	NO. 5 SIRA KLEMENSLER (16-25 MM2)	50 ad.	500	5,566
ISIYA DAYANIKLI SIRA KLEMENSLER				
015 094 170001	NO. 1 ISIYA DAYANIKLI KLEMENSLER (2.5-4 MM2)	50 ad.	1000	2,828
015 094 170002	NO. 2 ISIYA DAYANIKLI KLEMENSLER (4-6 MM2)	50 ad.	800	3,572
015 094 170003	NO. 3 ISIYA DAYANIKLI KLEMENSLER (6-10 MM2)	50 ad.	500	4,911
015 094 170004	NO. 4 ISIYA DAYANIKLI KLEMENSLER (10-16 MM2)	50 ad.	500	5,209
015 094 170005	NO. 5 ISIYA DAYANIKLI KLEMENSLER (16-25 MM2)	50 ad.	500	6,310
PORSELEN KLEMENSLER				
015 094 180002	NO. 1-2'Lİ PORSELEN KLEMENS	300 ad.		1,072
015 094 180003	NO. 1-3'LÜ PORSELEN KLEMENS	220 ad.		1,548
015 094 180004	NO. 2-2'Lİ PORSELEN KLEMENS	200 ad.		1,548
015 094 180005	NO. 2-3'LÜ PORSELEN KLEMENS	177 ad.		2,084
015 094 180006	NO. 3-2'Lİ PORSELEN KLEMENS	104 ad.		2,084
015 094 180007	NO. 3-3'Lİ PORSELEN KLEMENS	64 ad.		2,828
U KLEMENSLER				
014 094 030006	6'LİK U KLEMENSİ	300 ad.		1,637
014 094 030010	10'LÜK U KLEMENSİ	250 ad.		2,590
014 094 030016	16'LİK U KLEMENSİ	100 ad.		3,869
014 094 030025	25'LİK U KLEMENSİ	100 ad.		5,120
014 094 030035	35'LİK U KLEMENSİ	75 ad.		5,983
014 094 030050	50'LİK U KLEMENSİ	50 ad.		8,513
014 094 030070	70'LİK U KLEMENSİ	40 ad.		10,775
014 094 030095	95'LİK U KLEMENSİ	25 ad.		16,222
014 094 030120	120'LİK U KLEMENSİ	20 ad.		17,918
014 094 030150	150'LİK U KLEMENSİ	15 ad.		23,484
MOTOR KLEMENSLER				
022 094 200001	NO. 1 MOTOR KLEMENS	50 ad.		3,406
022 094 200002	NO. 2 MOTOR KLEMENS	50 ad.		3,963
022 094 200003	NO. 3 MOTOR KLEMENS	50 ad.		5,135
022 094 200004	NO. 4 MOTOR KLEMENS	40 ad.		7,470
022 094 200005	NO. 5 MOTOR KLEMENS	15 ad.		13,891
022 094 200006	NO. 6 MOTOR KLEMENS	6 ad.		24,567
TIRNAKLI KLEMENSLER				
014 094 100001	NO:1 TIRNAKLI KLEMENS 16MM	500 ad.		2,834
014 094 100002	NO:2 TIRNAKLI KLEMENS 25MM	250 ad.		3,828
014 094 100003	NO:3 TIRNAKLI KLEMENS 35MM	100 ad.		5,060
014 094 100004	NO:4 TIRNAKLI KLEMENS 50MM	100 ad.		7,411
014 094 100005	NO:5 TIRNAKLI KLEMENS 70MM	100 ad.		9,168
014 094 100006	NO:6-7 TIRNAKLI KLEMENS 95MM	50 ad.		18,246





Kod	Açıklama / Stok Cinsi	Amb. (Kutu/Bag)	Amb. (Koli/Çv.)	FİYAT
KAPI VE MERDİVEN OTOMATIĞI				
027 112 000001	GİZLİ KAPI OTOMATIĞI (DOKUNMATİK)	1 ad.	20	56,553
027 112 000002	GİZLİ KAPI OTOMATIĞI (BASMATİK)	1 ad.	20	56,553
027 112 000007	ELEK. KİLİTLİ (ANAHTARLI) KAPI OTOMATIĞI	1 ad.	12	107,153
027 112 000009	ELEKTRİKLİ KİLİTLİ KAPI OTOMATIĞI (BİLYELİ)	1 ad.	12	107,153
027 112 000003	BUTONLU KAPI OTOMATIĞI	1 ad.	30	40,182
028 112 000004	KAPI OTOMATIĞI (NORMAL)	1 ad.	30	38,694
027 112 000005	MERDİVEN OTOMATIĞI (RAYLI)	1 ad.	30	32,741
027 112 000006	MERDİVEN OTOMATIĞI (NORMAL)	1 ad.	30	32,741
ZİL BUTONU ÇEŞİTLERİ				
037 106 000005	1'Lİ DEKORATİF TİP PLASTİK ZİL BUTONU	1 ad.	40 ad.	3,430
037 106 020001	1'Lİ ALÜMİNYUM ZİL BUTONU 1.KALİTE	1 ad.		4,762
037 106 020002	2'Lİ ALÜMİNYUM ZİL BUTONU 1.KALİTE	1 ad.		9,525
037 106 020003	3'LÜ ALÜMİNYUM ZİL BUTONU 1.KALİTE	1 ad.		14,287
037 106 020004	4'LÜ ALÜMİNYUM ZİL BUTONU 1.KALİTE	1 ad.		19,049
037 106 020005	5'Lİ ALÜMİNYUM ZİL BUTONU 1.KALİTE	1 ad.		23,812
037 106 020006	6'Lİ ALÜMİNYUM ZİL BUTONU 1.KALİTE	1 ad.		28,574
037 106 020007	7'Lİ ALÜMİNYUM ZİL BUTONU 1.KALİTE	1 ad.		33,336
037 106 020008	8'Lİ ALÜMİNYUM ZİL BUTONU 1.KALİTE	1 ad.		38,099
037 106 020009	9'LU ALÜMİNYUM ZİL BUTONU 1.KALİTE	1 ad.		42,861
037 106 020010	10'LU ALÜMİNYUM ZİL BUTONU 1.KALİTE	1 ad.		47,624
ZİLLER VE ZİL TRAFOLARI				
027 105 010012	ZİL TRAFOSU 12 V	1 ad.	80	16,073
027 105 010015	ZİL TRAFOSU 15 V	1 ad.	30	28,276
028 105 020003	KAMPANA ZİL 220 V	1 ad.	24	52,088
028 105 020004	KAMPANA ZİL 12V, 24V, 110V	1 ad.	24	59,529
028 105 020000	MUNZAM ZİL ROLESİ	1 ad.	100	32,741
018 105 000006	KANARYA ZİL (TEK SES)	1 ad.	50	11,162
018 105 000007	KANARYA ZİL (ÜÇ SES)	1 ad.	50	12,204
018 105 000001	TELEFON ZİLİ (AYARLI)	1 ad.	50	13,394
018 105 000002	DİNG DONG ZİL ELEKTRONİK (3 SES)	1 ad.	50	14,882
018 105 000003	MEKANİK DİNG DONG ZİL	1 ad.	20	53,576
018 105 000004	KONUŞAN ZİL 120 MELODİ	1 ad.	30	21,431
DIYAFON MERKEZİ VE ŞUBELERİ				
018 104 000001	DIYAFON MERKEZİ 1"LI	1 ad.		119,059
018 104 000002	DIYAFON MERKEZİ 2"LI	1 ad.		125,012
018 104 000003	DIYAFON MERKEZİ 3"LU	1 ad.		130,965
018 104 000004	DIYAFON MERKEZİ 4"LU	1 ad.		136,918
018 104 000005	DIYAFON MERKEZİ 5"LI	1 ad.		142,871
018 104 000099	DIYAFON ŞUBESİ	1 ad.		11,906
İTHAL ÜRÜNLERİMİZ				
065 133 001018	10X18 İZOLE BANT – NITTO	10 ad.	250 ad.	0,393 \$
065 133 001019	10X19 İZOLE BANT - GLOBE	10 ad.	500 ad.	0,599 \$
999 999 000081	9V PİLLİ DUMAN DEDEKTÖRÜ	1 ad.		14,824 \$
999 999 000080	KABLOLU GAZ DEDEKTÖRÜ	1 ad.		14,287 \$
888 038 250027	360 DERECE PIR HAREKET SENSÖRÜ	1 ad.		16,153 \$
999 133 011019	ERİYEN BANT	1 ad.		2,446 \$
065 133 020000	ÇİFT TARAFLI BANT 1mm 20mm x 50mt	50 mt.		6,406 €
065 133 020003	ÇİFT TARAFLI BANT 1mm 25mm x 50mt	50 mt.		8,007 €
065 133 020001	ÇİFT TARAFLI BANT 1mm 30mm x 50mt	50 mt.		9,609 €



ÜRÜN KODU
888 038 218000

ÜRÜN ADI
Q218 KABLOSUZ KAPI ZİLİ
LEDLİ 100 MT. 32MELODİ

AMBALAJ ADET / KOLİ
1 ad. / 10

FİYAT
14,469 \$



ÜRÜN KODU
888 038 007000

ÜRÜN ADI
007-D KAPI/PENCERE
ALARMI 2 SESLİ

AMBALAJ ADET / KOLİ
1 ad. / 10

FİYAT
4,672 \$



ÜRÜN KODU
888 038 008000

ÜRÜN ADI
008-C LEDLİ İNFAR. PIR. SEN.
ALARM/KAPI ZİL 32M.8MT

AMBALAJ ADET / KOLİ
1 ad. / 10

FİYAT
15,799 \$



ÜRÜN KODU
018 105 114800

ÜRÜN ADI
A-148 KAPI ZİLİ
(32 MELODİLİ)

AMBALAJ ADET / KOLİ
1 ad. / 10

FİYAT
19,448 \$



ÜRÜN KODU
018 105 158100

ÜRÜN ADI
X-581 KAPI ZİLİ
(32 MELODİLİ)

AMBALAJ ADET / KOLİ
1 ad. / 10

FİYAT
19,448 \$



ÜRÜN KODU
018 105 162800

ÜRÜN ADI
WA-628 KAPI ZİLİ
(32 MELODİLİ) BEYAZ

AMBALAJ ADET / KOLİ
1 ad. / 10

FİYAT
21,538 \$



ÜRÜN KODU
018 105 162811

ÜRÜN ADI
WA-628 KAPI ZİLİ
(32 MELODİLİ) SİYAH

AMBALAJ ADET / KOLİ
1 ad. / 10

FİYAT
21,538 \$



ÜRÜN KODU
018 105 163800

ÜRÜN ADI
WA-638 KAPI ZİLİ
(32 MELODİLİ) BEYAZ

AMBALAJ ADET / KOLİ
1 ad. / 10

FİYAT
21,538 \$



ÜRÜN KODU
018 105 163811

ÜRÜN ADI
WA-638 KAPI ZİLİ
(32 MELODİLİ) SİYAH

AMBALAJ ADET / KOLİ
1 ad. / 10

FİYAT
21,538 \$

YANGIN ALGILAMA SİSTEMLERİ



Kod	Açıklama / Stok Cinsi	Amb. (Kutu/Bag)	Amb. (Kali/Çv.)	TL
DÖNER LAMBA FLAŞÖR SİREN REFKONTAK				
001 111 020004 00 00	DÖNER LAMBA 220 V AC	1 ad.		104,176
001 111 020001 00 00	DÖNER LAMBA 12 V AC	1 ad.		104,176
001 111 020002 00 00	DÖNER LAMBA 24 V AC	1 ad.		104,176
001 111 030003 00 00	FLAŞÖRLÜ İKAZ LAMBASI 220 V	1 ad.		62,506
026 111 020005	12 V.DC.MIKNATISLI DÖNER LAMBA(OTO TİPİ)	1 ad.		148,824
102 111 000012	LEDLİ FLAŞÖRLÜ ELEKTRONİK SİREN 12V	1 ad.		49,112
102 111 000024	LEDLİ FLAŞÖRLÜ ELEKTRONİK SİREN 24V	1 ad.		49,112
102 111 000220	LEDLİ FLAŞÖRLÜ ELEKTRONİK SİREN 220V	1 ad.		53,576
026 111 000001	UÇAK İKAZ LAMBASI (AMPULLÜ)	1 ad.		148,824
026 111 000002	UÇAK İKAZ LAMBA SEHPASI	1 ad.		104,363
888 111 050004	MS190 MINI SİREN (105 db)	1 ad.		18,040 \$
001 999 050005 00 00	MS290P PLASTİK SİREN 220V (80 db.)	1 ad.		21,389
026 111 010001	AS. 1 MOTORLU SİREN (PLS. GÖV.)220V,150W (110 db.)	1 ad.		89,294
026 111 010002	AS. 2 MOTORLU SİREN (PLS.GÖV.)220V,200W (115 db.)	1 ad.		133,941
026 111 010003	AS. 1 MOTORLU SİREN (METAL.GÖV.)220V,150W (112 db.)	1 ad.		148,824
026 111 010004	AS. 2 MOTORLU SİREN (METAL.GÖV.)220V,200W (117 db.)	1 ad.		184,541
026 111 010005	AS.3 MOTORLU SİREN 220V-280W (150 db.)	1 ad.		1.012,000

ALARM KORNA VE YANGIN İHBAR BUTONU

Kod	Açıklama / Stok Cinsi	Amb. (Kutu/Bag)	Amb. (Kali/Çv.)	TL
010 090 050050	RESETELEBİLİR BUTON	2 ad.		47,624
010 090 050051	RESETELEBİLİR BUTON (KAPAKLI)	1 ad.		52,088
028 120 010006	ALARM KORNA PLASTİK	1 ad.		50,600
028 120 010005	ALARM KORNA DÖKÜM	1 ad.		53,576





Kod	Açıklama / Stok Cinsi	Amb. (Kutu/Bağ)	Amb. (Koli/Çkt)	FİYAT
YANGIN İHBAR KONTROL PANELLERİ STANDART				
006 086 601004	EFIRE ECP-1004 4 ZONLU KONTROL PANELİ	1 ad.		220,00 \$
006 086 601008	EFIRE ECP-1008 8 ZONLU KONTROL PANELİ	1 ad.		240,00 \$
006 086 601012	EFIRE ECP-1012 12 ZONLU KONTROL PANELİ	1 ad.		270,00 \$
006 086 601016	EFIRE ECP-1016 16 ZONLU KONTROL PANELİ	1 ad.		320,00 \$
006 086 601036	EFIRE-EEXP-1 4 ALGILAMA + 1 SÖNDÜRME BÖLGEİ PANELİ	1 ad.		425,00 \$
006 086 601040	EFIRE-EEXP-2 4 ALGILAMA + 2 SÖNDÜRME BÖLGEİ PANELİ	1 ad.		475,00 \$
YANGIN İHBAR KONTROL TEKRARLAMA PANELLERİ				
006 086 001005	EFIRE ECP-RP 4 ZONLU TEKRARLAMA PANELİ	1 ad.		180,00 \$
006 086 001007	EFIRE ECP-RP 8 ZONLU TEKRARLAMA PANELİ	1 ad.		195,00 \$
006 086 001012	EFIRE ECP-RP 12 ZONLU TEKRARLAMA PANELİ	1 ad.		210,00 \$
006 086 001017	EFIRE ECP-RP 16 ZONLU TEKRARLAMA PANELİ	1 ad.		300,00 \$
006 086 200015	E-NW-485 TEKRARLAMA PANEL NETWORK KARTI	1 ad.		75,00 \$
KURU VE SIZDIRMAZ TİP BAKIM GEREKTİRMEYEN AKÜLER				
006 086 101220	BAT-1220 12V / 2AH. KURU TİP AKÜ	1 ad.		29,00 \$
006 086 101270	BAT-1270 12V / 7AH. KURU TİP AKÜ	1 ad.		35,00 \$
YANGIN İHBAR DEDEKTÖRLERİ				
006 086 200001	EFIRE EOD OPTİK DUMAN DEDEKTÖRÜ	1 ad.		19,00 \$
006 086 200005	EFIRE EHD-58 SABİT SICAKLIK DEDEKTÖRÜ-58 C	1 ad.		14,00 \$
006 086 200006	EFIRE EHD-82 SABİT SICAKLIK DEDEKTÖRÜ-82 C	1 ad.		14,00 \$
006 086 200002	EFIRE ERD SICAKLIK ARTIŞ HIZI DEDEKTÖRÜ	1 ad.		14,00 \$
006 086 326225	EFIRE ECD KOMBİNE (DUMAN+İSİ) DEDEKTÖRÜ	1 ad.		26,00 \$
006 086 200003	EFIRE EDB STANDART DEDEKTÖR SOKETİ	1 ad.		3,00 \$
YANGIN İHBAR BUTON, SİRENLERİ VE AKSESUARLARI				
006 086 300001	EFIRE EYİB YNG.İHB.BUT. VE KASASI 12-24V	1 ad.		12,00 \$
006 086 401224	AS-1224 ELEKTRONİK SİREN	1 ad.		13,00 \$
006 086 500009	AS-1224-LED FLAŞÖRLÜ ELEKTRONİK SİREN	1 ad.		25,00 \$
006 086 700009	E-PIL-PARALEL İHBAR LAMBASI	1 ad.		12,00 \$
999 999 777149	EGD 200-220-LPG GAZ DEDEKTÖRÜ 220V	1 ad.		30,00 \$
999 999 777164	EGD 200-24-LPG GAZ DEDEKTÖRÜ 12-24V	1 ad.		30,00 \$
006 086 400220	AS220-ELEKTRONİK SİREN 220V	1 ad.		15,00 \$
006 086 500010	AS220-LED ELEKTRONİK SİREN 220V	1 ad.		27,00 \$
006 125 100110	EFIRE EYİB NO/NC-YANGIN İHBAR BUTONU NO/NC ÇIKIŞLI 220V	1 ad.		14,00 \$
006 125 100120	EFIRE-EFB-6" YANGIN ÇANI	1 ad.		26,00 \$
ÖZEL AMAÇLI ÜRÜNLER				
006 086 700010	DLFB-R-İŞİN TİPİ BEAM DEDEKTÖR 3-100 MT / SD3	1 ad.		810,00 €
006 086 700011	DLFB30-R-İŞİN TİPİ BEAM DEDEKTÖR 30MT / SD3	1 ad.		677,00 €
885 325 000138	NB-138-12VDC-SU BASKIN DEDEKTÖRÜ RÖLE ÇIKIŞI / WIZMART	1 ad.		26,00 \$
885 325 000606	NB-606-4-SIGARA DUMANI ALGILAMA DEDEKTÖRÜ 24V / WIZMART	1 ad.		55,00 \$
885 326 002000	FS2000E-DAHİLİ ORTAM ALEV DEDEKTÖRÜ / PULNIX	1 ad.		445,00 \$
885 326 005000	FS5000E-HARİCİ ORTAM ALEV DEDEKTÖRÜ / PULNIX	1 ad.		860,00 \$
999 999 000581	NFE-MEKANİK DEPREM SENSÖRÜ	1 ad.		450,00 \$
999 999 001191	SİSLIFT-2 ELEKTRONİK DEPREM SENSÖRÜ	1 ad.		250,00 \$
006 086 601044	EWLD-1224 SU BASKIN DEDEKTÖRÜ 12-24V	1 ad.		24,00 \$
ADRESLİ YANGIN İHBAR PANELLERİ VE AKSESUARLARI				
006 086 510240	SAYA 1 LOOP ADRESLİ PANEL 240 ADRES	1 ad.		950,00 €
006 086 530720	SAYA 3 LOOP ADRESLİ PANEL 720 ADRES	1 ad.		1.650,00 €
006 086 210001	V2100-1 LOOP ADRESLİ PANEL 240 ADRES / VELOX	1 ad.		1.625,00 \$
006 086 220002	V2200-2 LOOP ADRESLİ PANEL 480 ADRES / VELOX	1 ad.		2.625,00 \$
006 086 440033	4400-3L-3 LOOP ADRESLİ PANEL-720 ADRES / VELOX	1 ad.		5.658,00 \$
006 086 004020	4020-TEKRARLAMA PANELİ 4000 SERİ PANELLER İÇİN / VELOX	1 ad.		2.080,00 \$
006 086 004420	4420-RS 485 PANELLER NETWORK KARTI / VELOX	1 ad.		550,00 \$
006 086 500001	S-485 SAYA PANALLER İÇİN NETWORK KARTI	1 ad.		400,00 €
006 086 511000	SAYA-RP SAYA TEKRARLAMA PANELİ	1 ad.		685,00 €
ADRESLİ YANGIN İHBAR DEDEKTÖRLERİ				
888 888 000100	LV100-ADRESLİ DUMAN DEDEKTÖRÜ / VELOX	1 ad.		39,13 \$
888 888 000350	LV350-ADRESLİ İSİ DEDEKTÖRÜ / VELOX	1 ad.		39,13 \$
888 888 000200	LV200-ADRESLİ KOMBİNE DEDEKTÖRÜ / VELOX	1 ad.		44,50 \$
888 888 040900	40900-ADRESLİ DEDEKTÖR SOKETİ / VELOX	1 ad.		4,00 \$
YANGIN İHBAR BUTON, SİRENLERİ VE MODÜLLER				
888 888 040800	40800-ADRESLİ YANGIN İHBAR BUTONU / VELOX	1 ad.		48,00 \$
888 888 040300	40300-ADRESLİ SİREN / VELOX	1 ad.		90,87 \$
888 888 040002	40002-2 Lİ ÇIKIŞ RÖLE MODÜLÜ / VELOX	1 ad.		61,00 \$
888 888 040010	40010-SİREN KONTROL MODÜLÜ (HARİCEN BESLENİR) / VELOX	1 ad.		74,00 \$
888 888 040100	40100-TEKLİ GİRİŞ İZLEME MODÜLÜ / VELOX	1 ad.		53,00 \$
888 888 040102	40102-TEKLİ GİRİŞ (İZLEME) 2'Lİ ÇIKIŞ RÖLE MODÜLÜ / VELOX	1 ad.		88,00 \$
888 888 040110	40110-TEKLİ GİRİŞ (İZLEME) VE SİREN KONTROL MODÜLÜ / VELOX	1 ad.		85,00 \$
888 888 040500	40500-KONVANSİYONEL ZON MODÜLÜ / VELOX	1 ad.		173,00 \$



GLOBAL
FIRE EQUIPMENT
Manufacturers of Fire Detection Equipment



Kod	Açıklama / Stok Cinsi	FİYAT
KONVANSİYONEL YANGIN İHBAR KONTROL PANELLERİ		
006 089 000001	ORION1 1 ZONLU KONTROL PANELİ - MINI KASA	170,00 \$
006 089 000002	ORION2 2 ZONLU KONTROL PANELİ - MINI KASA	190,00 \$
006 089 000003	ORION4 4 ZONLU KONTROL PANELİ - ORTA KASA	210,00 \$
006 089 000004	ORION8 8 ZONLU KONTROL PANELİ - ORTA KASA	230,00 \$
006 089 000005	ORION12 PLUS 12 ZONLU KONTROL PANELİ - GENİŞ KASA	360,00 \$
006 089 000006	ORION16 PLUS 16 ZONLU KONTROL PANELİ - GENİŞ KASA	440,00 \$
KONVANSİYONEL YANGIN İHBAR KONTROL TEKRARLAMA PANELLERİ		
006 089 000008	ORION MINI REP MINI TEKRARLAMA PANELİ - 4 VE 8 ZON İÇİN	225,00 \$
006 089 000009	ORION PLUS REP TEKRARLAMA PANELİ - 12 VE 16 ZON İÇİN	340,00 \$
006 089 000010	J-NET-INT-485 TEKRARLAMA PANELİ İÇİN NETWORK KARTI, UZAK MESAFELER İÇİN	210,00 \$
006 089 000011	ORION-INT-RS232 TEKRARLAMA PANELİ İÇİN NETWORK KARTI, YAKIN MESAFELER İÇİN-10 MT.	93,00 \$
KONVANSİYONEL YANGIN İHBAR KONTROL PANELLERİ		
006 089 000012	GFE-S-2L OPTİK DUMAN DEDEKTÖRÜ	21,00 \$
006 089 000013	GFE-H-2L SABİT SICAKLIK DEDEKTÖRÜ	19,00 \$
006 089 000014	GFE-SH-2L KOMBİNE (DUMAN+ISI) DEDEKTÖRÜ	33,50 \$
006 089 000015	SD119-2L OPTİK DUMAN DEDEKTÖRÜ - SENTEK	16,00 \$
006 089 000016	HD-912-2L SABİT SICAKLIK DEDEKTÖRÜ - SENTEK	15,00 \$
006 089 000017	SD119-2HL KOMBİNE (DUMAN+ISI) DEDEKTÖRÜ - SENTEK	24,00 \$
006 089 000018	SD-B STANDART DEDEKTÖR SOKET	3,00 \$
KONVANSİYONEL YANGIN İHBAR BUTON, SİREN ve AKSESUARLARI		
006 089 000019	GFE-MCPC YANGIN İHBAR BUTONU VE MONTAJ KASASI	12,00 \$
006 089 000020	GFE-MCPC-220 YANGIN İHBAR BUTONU VE MONTAJ KASASI, 220V	14,00 \$
006 089 000021	VULCAN-CS ELEKTRONİK SİREN	15,00 \$
006 089 000022	VULCAN-CB ELEKTRONİK FLAŞÖR	23,00 \$
006 089 000023	VULCAN-CSB FLAŞÖRLÜ ELEKTRONİK SİREN	23,00 \$
006 089 000024	VULCAN-CS 220 ELEKTRONİK SİREN, 220V	15,00 \$
ÖZEL AMAÇLI VE STAND ALONE ÜRÜNLER		
006 089 000025	SD119-4-12 OPTİK DUMAN DEDEKTÖRÜ VE SOKETİ, RÖLELİ, 12-24V	30,00 \$
006 089 000026	SD119-4SH-12 KOMBİNE(OPTİK+DUMAN) DEDEKTÖRÜ VE SOKETİ, RÖLELİ,12-24V	35,00 \$
006 089 000027	GFE-GAS-C 1224 LPG VE DOĞAL GAZ ALGILAMA DEDEKTÖRÜ, 12-24V	32,00 \$
006 089 000028	GFE-GAS-C 220 LPG VE DOĞAL GAZ ALGILAMA DEDEKTÖRÜ, 220V	32,00 \$
006 089 000029	DLFB-R İŞİN TİPİ BEAM DEDEKTÖR 3-100 MT.	840,00 €
006 089 000030	DLFB30-R İŞİN TİPİ BEAM DEDEKTÖR 30 MT.	650,00 €
006 089 000031	NB-138R-12V SU BASKINI ALGILAMA DEDEKTÖRÜ, RÖLE ÇIKIŞLI, 12V	25,00 \$
006 089 000032	GS506 PİLLİ DUMAN DEDEKTÖRÜ, 9V	12,00 \$
006 089 000033	RI9000 PARALEL İHBAR LAMBASI	8,00 €
006 089 000034	FS2000E DAHİLİ ORTAM ALEV DEDEKTÖRÜ	470,00 \$
006 089 000035	FS5000E HARİCİ ORTAM ALEV DEDEKTÖRÜ	930,00 \$
İNTELLİGENT ADRESLİ YANGIN İHBAR PANELLERİ VE AKSESUARLAR		
006 089 000036	JNR-V4-1 1 LOOP ADRESLİ YANGIN ALGILAMA PANEL, UFAK KASA, 125 ADRES	890,00 €
006 089 000037	JNR-V4-2 2 LOOP ADRESLİ YANGIN ALGILAMA PANEL, UFAK KASA, 250 ADRES	1.260,00 €
006 089 000038	J-NET-SC-001 1 LOOP ADRESLİ YANGIN ALGILAMA PANEL, ORTA KASA, 125 ADRES	1.520,00 €
006 089 000039	J-NET-SC-002 2 LOOP ADRESLİ YANGIN ALGILAMA PANEL, ORTA KASA, 250 ADRES	1.785,00 €
006 089 000040	J-NET-SC-003 3 LOOP ADRESLİ YANGIN ALGILAMA PANEL, ORTA KASA, 375 ADRES	2.060,00 €
006 089 000041	J-NET-SC-004 4 LOOP ADRESLİ YANGIN ALGILAMA PANEL, ORTA KASA, 500 ADRES	2.615,00 €
006 089 000042	JUNIOR-MINI-REP TEKRARLAMA (REPEATER) PANELİ	655,00 €
006 089 000043	J-NET-INT-485 NETWORK HABELŞME KARTI	190,00 €
İNTELLİGENT ADRESLİ YANGIN İHBAR DEDEKTÖRLERİ		
006 089 000044	GFE-ZEOS-AS-S ADRESLİ OPTİK DUMAN DEDEKTÖRÜ	34,00 €
006 089 000045	GFE-ZEOS-AS-H ADRESLİ SCAKLIK DEDEKTÖRÜ	34,00 €
006 089 000046	GFE-ZEOS-AS-SH ADRESLİ KOMBİNE (OPTİK+ISI) DEDEKTÖRÜ	42,00 €
006 089 000047	GFE-ZEOS-AS-SI ADRESLİ OPTİK DUMAN DEDEKTÖRÜ, KISA DEVRE İZOLATÖRLÜ	42,00 €
006 089 000048	GFE-ZEOS-AS-HI ADRESLİ SCAKLIK DEDEKTÖRÜ, KISA DEVRE İZOLATÖRLÜ	42,00 €
006 089 000049	GFE-ZEOS-AS-SHI ADRESLİ KOMBİNE (OPTİK+ISI) DEDEKTÖRÜ, KISA DEVRE İZOLATÖRLÜ	44,00 €
006 089 000050	GFE-ZEOS-BASE ADRESLİ ZEOS DEDEKTÖR SOKETİ	4,00 €
006 089 000051	GFE-GAS-A ADRESLİ GAZ DEDEKTÖRÜ	55,00 €
İNTELLİGENT ADRESLİ YANGIN İHBAR BUTON, SİREN VE MODÜLLERİ		
006 089 000052	GFE-MCPE-A ADRESLİ YANGIN İHBAR BUTONU VE MONTAJ KASASI	44,00 €
006 089 000053	VALKYRIE AS ADRESLİ ELEKTRONİK SİREN	63,00 €
006 089 000054	VALKYRIE AB ADRESLİ ELEKTRONİK FLAŞÖR	63,00 €
006 089 000055	VALKYRIE ASB ADRESLİ ELEKTRONİK FLAŞÖRLÜ SİREN	84,00 €
MODÜLLER		
006 089 000056	3 I/O - PLUS 1 CH GİRİŞ - ÇIKIŞ RÖLE MODÜLÜ - 1'Lİ	74,00 €
006 089 000057	3 I/O - PLUS 2 CH GİRİŞ - ÇIKIŞ RÖLE MODÜLÜ - 2'Lİ	99,00 €
006 089 000058	3 I/O - PLUS 3 CH GİRİŞ - ÇIKIŞ RÖLE MODÜLÜ - 3'LÜ	120,00 €
006 089 000059	4 INPUT 4 GİRİŞLİ KONTAK İZLEME MODÜLÜ	115,00 €
006 089 000060	8 INPUT 8 GİRİŞLİ KONTAK İZLEME MODÜLÜ	220,00 €
006 089 000061	GFE-AD-ISO KISA DEVRE İZOLATÖR MODÜLÜ	42,00 €
006 089 000062	LSC-ISO LOOP SİREN KONTROL MODÜLÜ	74,00 €
006 089 000063	ZMU KONVANSİYONEL BÖLGE DENETİM MODÜLÜ - BUTON, BEAM VE GAZ DEDEKTÖRÜ	89,00 €
006 089 000064	MAM-RED KONTAK İZLEME MODÜLÜ	23,00 €





Kod	Açıklama / Stok Cinsi	FİYAT
MAXLOGIC SERİSİ KONVANSİYONEL YANGIN ALARM SANTRALLERİ		
006 090 022102	ML-22102 KONVANSİYONEL YANGIN ALARM SANTRALI, 2 BÖLGE	475,00\$
006 090 022104	ML-22104 KONVANSİYONEL YANGIN ALARM SANTRALI, 4 BÖLGE	500,00\$
006 090 022108	ML-22108 KONVANSİYONEL YANGIN ALARM SANTRALI, 8 BÖLGE	600,00\$
006 090 022116	ML-22116 KONVANSİYONEL YANGIN ALARM SANTRALI, 16 BÖLGE	700,00\$
MAXLOGIC KONVANSİYONEL STANDART YANGIN ALGILAMA DEDEKTÖRLERİ		
006 090 002110	ML-2110 OPTİK DUMAN DEDEKTÖRÜ	28,00\$
006 090 002120	ML-2120 KOMBİNE SICAKLIK DEDEKTÖRÜ	24,00\$
006 090 002130	ML-2130 SABİT SICAKLIK DEDEKTÖRÜ	24,00\$
006 090 002140	ML-2140 MULTİSENSÖR DEDEKTÖRÜ	42,00\$
006 090 000140	ML-0140 DEDEKTÖR SOKETİ	6,00\$
MAVİGARD KONVANSİYONEL RÖLE ÇIKIŞLI YANGIN ALGILAMA DEDEKTÖRLERİ		
006 090 002100	MGR-2100 OPTİK DUMAN DEDEKTÖRÜ, RÖLE ÇIKIŞLI, 12V DC	28,00\$
006 090 002500	MGR-2500 MULTİSENSÖR DEDEKTÖR (OPTİK DUMAN+SICAKLIK), RÖLE ÇIKIŞLI, 12V DC	42,00\$
006 090 003500	MG-3500 DEDEKTÖR SOKETİ (MGR SERİSİ İÇİN)	6,00\$
MAXLOGIC KONVANSİYONEL İŞİN (BEAM) TİPİ DUMAN DEDEKTÖRLERİ		
006 090 002170	ML-2170 İŞİN (BEAM) TİPİ DUMAN DEDEKTÖRÜ (ALICI-VERİCİ DAHİL)	1.350,00\$
006 090 002171	ML-2171 İŞİN (BEAM) TİPİ DUMAN DEDEKTÖRÜ ALICISI	900,00\$
006 090 002172	ML-2172 İŞİN (BEAM) TİPİ DUMAN DEDEKTÖRÜ VERİCİSİ	450,00\$
006 090 002173	ML-2173 REFLEKTÖRLÜ İŞİN (BEAM) TİPİ DUMAN DEDEK. (ALICI-VERİCİ-REFLEKTÖR DAHİL)	1.225,00\$
006 090 002174	ML-2174 REFLEKTÖRLÜ İŞİN (BEAM) TİPİ DUMAN DEDEKTÖRÜ, ALICI-VERİCİ ÜNİTESİ	1.225,00\$
006 090 000171	ML-0171 İŞİN (BEAM) TİPİ DUMAN DEDEKTÖRÜ REFLEKTÖRÜ, 1'Lİ	100,00\$
006 090 000174	ML-0174 İŞİN (BEAM) TİPİ DUMAN DEDEKTÖRÜ REFLEKTÖRÜ, 4'LÜ	400,00\$
MAXLOGIC ELEKTRONİK SİREN, FLAŞÖRLÜ SİREN VE AKSESUARLAR		
006 090 002410	ELEKTRONİK SİREN, KIRMIZI 24V DC	50,00\$
006 090 002420	ELEKTRONİK FLAŞÖR	55,00\$
006 090 002430	FLAŞÖRLÜ ELEKTRONİK SİREN, KIRMIZI 24V DC	65,00\$
006 090 002710	KONVANSİYONEL SİSTEM YANGIN ALARM BUTONU, RESETLENEBİLİR	22,00\$
MAVİGARD İKİ ALARM SEVİYESİ ÇIKIŞLI, ELEKTROKİMYASAL SENSÖRLÜ KONVANSİYONEL GAZ DEDEKTÖRLERİ		
006 090 002012	GD2R-12EC KARBONMONOKSİT GAZ DEDEK. (CO), 12V DC, 2 ALR. SEV. ÇIKIŞLI, ELEKTROKİMYASAL	150,00\$
006 090 002024	GD2R-24EC KARBONMONOKSİT GAZ DEDEK. (CO), 24V DC, 2 ALR. SEV. ÇIKIŞLI, ELEKTROKİMYASAL	150,00\$
006 090 002220	GD2R-220EC KARBONMONOKSİT GAZ DEDEK. (CO), 230V AC, 2 ALR. SEV. ÇIKIŞLI, ELEKTROKİMYASAL	150,00\$
006 090 000120	ML-0120 SIVA ÜSTÜ BAĞLANTI KUTUSU	15,00\$
GD / GDR / TGDR SERİSİ KONVANSİYONEL GAZ DEDEKTÖRLERİ		
006 090 041224	GDR-1224L LPG (BÜTAN+PROPAN) DEDEKTÖRÜ, 12/24V DC, RÖLE ÇIKIŞLI	60,00\$
006 090 051224	GDR-1224M METAN (DOĞALGAZ) DEDEKTÖRÜ, 12/24V DC, RÖLE ÇIKIŞLI	60,00\$
006 090 040220	GDR-220L LPG (BÜTAN+PROPAN) DEDEKTÖRÜ, 230V AC, RÖLE ÇIKIŞLI	60,00\$
006 090 050220	GDR-220M METAN (DOĞALGAZ) DEDEKTÖRÜ, 230V AC, RÖLE ÇIKIŞLI	60,00\$
006 090 060220	GD-220L LPG (BÜTAN+PROPAN) DEDEKTÖRÜ, 230V AC	60,00\$
006 090 070220	GD-220M METAN (DOĞALGAZ) DEDEKTÖRÜ, 230V AC	60,00\$
006 090 080220	GD-220EC KARBONMONOKSİT DEDEKTÖRÜ, 230V AC, ELEKTROKİMYASAL	130,00\$
006 090 061224	TGDR-1224M TAVAN TİPİ DOĞALGAZ (METAN) DEDEKTÖRÜ, 12/24V DC, RÖLELİ	60,00\$
006 090 000120	ML-0120 SIVA ÜSTÜ BAĞLANTI KUTUSU	15,00\$
MAXLOGIC SERİSİ AKILLI ADRESLİ YANGIN ALARM SANTRALLERİ, 8 ÇEVİRİME KADAR		
006 090 001230	ML-1230 YANGIN ALARM SANTRALI, ÇEVİRİMSİZ	1.250,00\$
006 090 001231	ML-1231 YANGIN ALARM SANTRALI, 1 ÇEVİRİM, 127 ADRES	1.750,00\$
006 090 001232	ML-1232 YANGIN ALARM SANTRALI, 2 ÇEVİRİM, 254 ADRES	2.500,00\$
006 090 001233	ML-1233 YANGIN ALARM SANTRALI, 3 ÇEVİRİM, 381 ADRES	3.250,00\$
006 090 001234	ML-1234 YANGIN ALARM SANTRALI, 4 ÇEVİRİM, 508 ADRES	4.000,00\$
MAVİGARD / MAXLOGIC AKILLI ADRESLİ YANGIN ALGILAMA DEDEKTÖRLERİ		
006 090 009100	MG-9100 OPTİK DUMAN DEDEKTÖRÜ	60,00\$
006 090 009300	MG-9300 ISI DEDEKTÖRÜ	60,00\$
006 090 009400	MG-9400 MULTİSENSÖR DEDEKTÖRÜ (OPTİK DUMAN+ISI)	90,00\$
006 090 001110	ML-1110 OPTİK DUMAN DEDEKTÖRÜ	70,00\$
006 090 001130	ML-1130 SICAKLIK DEDEKTÖRÜ	70,00\$
006 090 001140	ML-1140 MULTİSENSÖR DEDEKTÖRÜ	100,00\$
006 090 051110	ML-1110.SCI OPTİK DUMAN DEDEKTÖRÜ, KISA DEVRE İZOLATÖRLÜ	80,00\$
006 090 051130	ML-1130.SCI SICAKLIK DEDEKTÖRÜ, KISA DEVRE İZOLATÖRLÜ	80,00\$
006 090 051140	ML-1140.SCI MULTİSENSÖR DEDEKTÖRÜ, KISA DEVRE İZOLATÖRLÜ	120,00\$
006 090 000140	ML-0140 DEDEKTÖR SOKETİ	6,00\$
006 090 003510	MG-3510 DEDEKTÖR SOKETİ	6,00\$
MAXLOGIC AKILLI ADRESLİ YANGIN ALGILAMA VE ALARM SİSTEMLERİ İÇİN AKSESUARLAR		
006 090 001410	ML-1410 ADRESLİ SİREN	140,00\$
006 090 051410	ML-1410.SCI ADRESLİ SİREN, KISA DEVRE İZOLATÖRLÜ	160,00\$
006 090 001420	ML-1420 ADRESLİ FLAŞÖR	160,00\$
006 090 051420	ML-1420.SCI ADRESLİ FLAŞÖR, KISA DEVRE İZOLATÖRLÜ	180,00\$
006 090 001430	ML-1430 ADRESLİ FLAŞÖRLÜ SİREN	180,00\$
006 090 051430	ML-1430.SCI ADRESLİ FLAŞÖRLÜ SİREN, KISA DEVRE İZOLATÖRLÜ	200,00\$
006 090 001710	ML-1710 ADRESLENEBİLİR YANGIN ALARM BUT., RESETLENEBİLİR, MONTAJ KASASI DAHİL	70,00\$
006 090 051710	ML-1710.SCI ADRESLENEBİLİR YANGIN ALR. BUT., KISA DEVRE İZOLATÖRLÜ, RESETLENEBİLİR	90,00\$
MAVİGARD AGD SERİSİ AKILLI ADRESLİ GAZ DEDEKTÖRLERİ		
006 090 011224	AGD-1224L/VIP LPG (BÜTAN+PROPAN) DEDEKTÖRÜ, 12/24V DC	135,00\$
006 090 021224	AGD-1224M/VIP METAN (DOĞALGAZ) DEDEKTÖRÜ, 12/24V DC	135,00\$
006 090 031224	AGD-1224EC/VIP KARBONMONOKSİT DEDEKTÖRÜ, 24V DC, ELEKTROKİMYASAL	200,00\$
006 090 010220	AGD-220L/VIP LPG (BÜTAN+PROPAN) DEDEKTÖRÜ, 230V AC	160,00\$
006 090 020220	AGD-220M/VIP METAN (DOĞALGAZ) DEDEKTÖRÜ, 230V AC	160,00\$
006 090 030220	AGD-220EC/VIP KARBONMONOKSİT DEDEKTÖRÜ, 230V AC, ELEKTROKİMYASAL	200,00\$
006 090 000120	ML-0120 SIVA ÜSTÜ BAĞLANTI KUTUSU	15,00\$
MAXLOGIC AKILLI ADRESLİ İŞİN (BEAM) TİPİ DUMAN DEDEKTÖRLERİ		
006 090 001170	ML-1170 İŞİN (BEAM) TİPİ DUMAN DEDEK. (ALICI-VERİCİ DAHİL)	1.625,00\$
006 090 051170	ML-1170.SCI İŞİN (BEAM) TİPİ DUMAN DEDEK. KISA DEVRE İZOLATÖRLÜ (ALICI-VERİCİ DAHİL)	1.650,00\$
006 090 001171	ML-1171 İŞİN (BEAM) TİPİ DUMAN DEDEK. ALICISI	1.050,00\$
006 090 051171	ML-1171.SCI İŞİN (BEAM) TİPİ DUMAN DEDEK. ALICISI, KISA DEVRE İZOLATÖRLÜ	1.100,00\$
006 090 001172	ML-1172 İŞİN (BEAM) TİPİ DUMAN DEDEK. VERİCİSİ	550,00\$
006 090 001173	ML-1173 REFLEKTÖRLÜ İŞİN (BEAM) TİPİ DUMAN DEDEK. (ALICI-VERİCİ-REFLEKTÖR DAHİL)	1.500,00\$
006 090 051173	ML-1173.SCI REFLEKTÖRLÜ İŞİN (BEAM) TİPİ DUMAN DEDEK.KISA DEVRE İZOLATÖRLÜ (ALICI-VERİCİ-REFL. DAHİL)	1.525,00\$
006 090 001174	ML-1174 REFLEKTÖRLÜ İŞİN (BEAM) TİPİ DUMAN DEDEK. ALICI-VERİCİ ÜNİTESİ	1.475,00\$
006 090 051174	ML-1174.SCI REFLEKTÖRLÜ İŞİN (BEAM) TİPİ DUMAN DEDEK. ALICI-VERİCİ ÜNİTESİ, KISA DEVRE İZOLATÖRLÜ	1.525,00\$



ASPIRATÖR ÇEŞİTLERİ



MUTLUSAN ASPİRATÖR ÇEŞİTLERİ



Ürün Kodu : 001 111 000100 00 00
Ürün Adı : MUTLUSAN 100 ASPİRATÖR
Amb. Ad./Koli : 1/20

FİYAT : 30,685



Ürün Kodu : 001 111 000120 00 00
Ürün Adı : MUTLUSAN 120 ASPİRATÖR
Amb. Ad./Koli : 1/20

FİYAT : 32,389



Ürün Kodu : 001 111 000150 00 00
Ürün Adı : MUTLUSAN 150 ASPİRATÖR
Amb. Ad./Koli : 1/20

FİYAT : 42,476



Ürün Kodu : 001 111 000200 00 00
Ürün Adı : MUTLUSAN 200 ASPİRATÖR
Amb. Ad./Koli : 1/20

FİYAT : 80,974

AIRCOL ASPİRATÖR ÇEŞİTLERİ



ÜRÜN KODU
029 088 110100
ÜRÜN ADI
AIRCOL 100
ASPİRATÖR
AMBALAJ ADET / KOLİ
1 ad. / 10
FİYAT
50,588 TL



ÜRÜN KODU
029 088 130049
ÜRÜN ADI
AIRCOL COMFORT 100
ASPİRATÖR (KROM)
AMBALAJ ADET / KOLİ
1 ad. / 10
FİYAT
68,235 TL



ÜRÜN KODU
029 088 120100
ÜRÜN ADI
AIRCOL 100 ASPİRATÖR
(OTOMATİK PANJURLU)
AMBALAJ ADET / KOLİ
1 ad. / 10
FİYAT
89,412 TL



ÜRÜN KODU
029 088 110120
ÜRÜN ADI
AIRCOL 120
ASPİRATÖR
AMBALAJ ADET / KOLİ
1 ad. / 10
FİYAT
56,471 TL



ÜRÜN KODU
029 088 130120
ÜRÜN ADI
AIRCOL COMFORT 120
ASPİRATÖR (KROM)
AMBALAJ ADET / KOLİ
1 ad. / 10
FİYAT
81,176 TL



ÜRÜN KODU
029 088 120120
ÜRÜN ADI
AIRCOL 120 ASPİRATÖR
(OTOMATİK PANJURLU)
AMBALAJ ADET / KOLİ
1 ad. / 10
FİYAT
103,529 TL



ÜRÜN KODU
029 088 110150
ÜRÜN ADI
AIRCOL 150
ASPİRATÖR
AMBALAJ ADET / KOLİ
1 ad. / 10
FİYAT
72,941 TL



ÜRÜN KODU
029 088 130051
ÜRÜN ADI
AIRCOL COMFORT 150
ASPİRATÖR (KROM)
AMBALAJ ADET / KOLİ
1 ad. / 10
FİYAT
90,588 TL



ÜRÜN KODU
029 088 120150
ÜRÜN ADI
AIRCOL 150 ASPİRATÖR
(OTOMATİK PANJURLU)
AMBALAJ ADET / KOLİ
1 ad. / 10
FİYAT
123,529 TL



ÜRÜN KODU
029 088 110200
ÜRÜN ADI
AIRCOL 200
ASPİRATÖR
AMBALAJ ADET / KOLİ
1 ad. / 10
FİYAT
101,176 TL



ÜRÜN KODU
029 088 130052
ÜRÜN ADI
AIRCOL COMFORT 200
ASPİRATÖR (KROM)
AMBALAJ ADET / KOLİ
1 ad. / 10
FİYAT
141,176 TL



ÜRÜN KODU
029 088 140250
ÜRÜN ADI
AIRCOL 250-K ASP.
(TAVAN TİPİ)
AMBALAJ ADET / KOLİ
1 ad. / 6
FİYAT
176,471 TL

AIRCOL ASPİRATÖR ÇEŞİTLERİ

 <p>ÜRÜN KODU 029 088 130043 ÜRÜN ADI AIRCOL-100KT KANAL TİPİ ASPİRATÖR AMBALAJ ADET / KOLİ 1 ad. / 10 FİYAT 43,529 TL</p>	 <p>ÜRÜN KODU 029 088 130150 ÜRÜN ADI AIRCOL 150-K ASPİRATÖR (KAPAKLI) AMBALAJ ADET / KOLİ 1 ad. / 10 FİYAT 94,118 TL</p>	 <p>ÜRÜN KODU 029 088 130046 ÜRÜN ADI AIRCOL-LÜX DUVAR VE TAVAN TİPİ ASPİRATÖR AMBALAJ ADET / KOLİ 1 ad. / 6 FİYAT 188,235 TL</p>
 <p>ÜRÜN KODU 029 088 130044 ÜRÜN ADI AIRCOL-120KT KANAL TİPİ ASPİRATÖR AMBALAJ ADET / KOLİ 1 ad. / 10 FİYAT 50,588 TL</p>	 <p>ÜRÜN KODU 029 088 130200 ÜRÜN ADI AIRCOL 200-K ASPİRATÖR (KAPAKLI) AMBALAJ ADET / KOLİ 1 ad. / 10 FİYAT 104,706 TL</p>	 <p>ÜRÜN KODU 029 088 130250 ÜRÜN ADI AIRCOL 250-2DF DUVAR TAVAN TİPİ ASPİRATÖR AMBALAJ ADET / KOLİ 1 ad. / 10 FİYAT 211,765 TL</p>
 <p>ÜRÜN KODU 029 088 130045 ÜRÜN ADI AIRCOL-150KT KANAL TİPİ ASPİRATÖR AMBALAJ ADET / KOLİ 1 ad. / 10 FİYAT 64,706 TL</p>	 <p>ÜRÜN KODU 029 088 131150 ÜRÜN ADI AIRCOL-150C MP CAM VE DUVAR TİPİ ASPİRATÖR AMBALAJ ADET / KOLİ 1 ad. / 10 FİYAT 137,647 TL</p>	 <p>ÜRÜN KODU 029 088 130055 ÜRÜN ADI AIRCOL SUMMER TAVAN TİPİ ASPİRATÖR AMBALAJ ADET / KOLİ 1 ad. / 6 FİYAT 123,529 TL</p>
 <p>ÜRÜN KODU 029 088 125100 ÜRÜN ADI AIRCOL 100-SM ASPİRATÖR (SWİTCHLİ) AMBALAJ ADET / KOLİ 1 ad. / 10 FİYAT 61,176 TL</p>	 <p>ÜRÜN KODU 029 088 132150 ÜRÜN ADI AIRCOL-150C OP CAM VE DUVAR TİPİ ASPİRATÖR AMBALAJ ADET / KOLİ 1 ad. / 10 FİYAT 158,824 TL</p>	 <p>ÜRÜN KODU 029 088 130042 ÜRÜN ADI AIRCOL SPRİNG LIGHT TAVAN TİPİ ASPİRATÖR AMBALAJ ADET / KOLİ 1 ad. / 6 FİYAT 147,059 TL</p>
 <p>ÜRÜN KODU 029 088 125120 ÜRÜN ADI AIRCOL 120-SM ASPİRATÖR (SWİTCHLİ) AMBALAJ ADET / KOLİ 1 ad. / 10 FİYAT 70,588 TL</p>	 <p>ÜRÜN KODU 029 088 130020 ÜRÜN ADI AIRCOL 20-K ASPİRATÖR (KAPAKLI) AMBALAJ ADET / KOLİ 1 ad. / 10 FİYAT 123,529 TL</p>	 <p>ÜRÜN KODU 029 088 130025 ÜRÜN ADI AIRCOL 25-K ASPİRATÖR (KAPAKLI) AMBALAJ ADET / KOLİ 1 ad. / 10 FİYAT 144,706 TL</p>
 <p>ÜRÜN KODU 029 088 136200 ÜRÜN ADI AIRCOL-200 KF RADYAL KANAL İÇİ FAN AMBALAJ ADET / KOLİ 1 ad. FİYAT 335,294 TL</p>	 <p>ÜRÜN KODU 029 088 137120 ÜRÜN ADI AIRCOL-120 AKS SALYANGOZ RADYAL FAN AMBALAJ ADET / KOLİ 1 ad. FİYAT 247,059 TL</p>	

	Kod	Açıklama / Stok Cinsi	Amb. (Kutu/Bag)	Amb. (Koli/Çv.)	FİYAT
	AIRCOL MS SERİSİ AKSİYEL FANLAR				
	029 088 170200	AIRCOL-200 MS AKSİYEL FAN	1 ad.		241,176
	029 088 170250	AIRCOL-250 MS AKSİYEL FAN	1 ad.		282,353
	029 088 170300	AIRCOL-300 MS AKSİYEL FAN	1 ad.		317,647
	AIRCOL S SERİSİ KARE MODEL AKSİYEL FANLAR				
	029 088 175300	AIRCOL-300 S KARE MODEL	1 ad.		282,353
	029 088 175400	AIRCOL-400 S KARE MODEL	1 ad.		311,765
	029 088 175450	AIRCOL-450 S KARE MODEL	1 ad.		541,176
029 088 075500	AIRCOL-500 S KARE MODEL	1 ad.		588,235	
	AIRCOL S SERİSİ SANAYİ TİPİ AKSİYEL FANLAR				
	029 088 130030	AIRCOL-300 S SANAYİ TİPİ	1 ad.		258,824
	029 088 130040	AIRCOL-400 S SANAYİ TİPİ	1 ad.		282,353
	029 088 130047	AIRCOL-450 S SANAYİ TİPİ	1 ad.		494,118
029 088 130048	AIRCOL-500 S SANAYİ TİPİ	1 ad.		529,412	
	AC AKSİYEL KAPAKLI ASPİRATÖRLER				
	080 088 200160	BK160MM KAPAKLI ASPİRATÖR (40WATT 1200 DEV/DAK)	1 ad.		155,294
	080 088 200200	BK200MM KAPAKLI ASPİRATÖR (40WAT 1200 DEV/DAK)	1 ad.		181,176
	080 088 200250	BK250MM KAPAKLI ASPİRATÖR (50WAT 1100 DEV/DAK)	1 ad.		220,000
080 088 200300	BK300MM KAPAKLI ASPİRATÖR (60WAT 1050 DEV/DAK)	1 ad.		271,765	
	AC AKSİYEL BACA ASPİRATÖRLER				
	080 088 160160	BB160MM BACA ASPİRATÖR (40WATT 1200 DEV/DAK)	1 ad.		142,353
	080 088 160200	BB200MM BACA ASPİRATÖR (40WAT 1200 DEV/DAK)	1 ad.		168,235
	080 088 160250	BB250MM BACA ASPİRATÖR (50WAT 1100 DEV/DAK)	1 ad.		207,059
080 088 160300	BB300MM BACA ASPİRATÖR (60WAT 1050 DEV/DAK)	1 ad.		245,882	
	MONOFAZE SANAYİ TİPİ ASPİRATÖRLER				
	080 088 002250	BSM250-2K MONOFAZE SANAYİ ASP.(180W 2900 DEV/DAK)	1 ad.		401,824
	080 088 000250	BSM250 MONOFAZE SANAYİ ASP.(160W 1480 DEV/DAK)	1 ad.		349,735
	080 088 000300	BSM300 MONOFAZE SANAYİ ASP.(180W 1400 DEV/DAK)	1 ad.		364,618
	080 088 000350	BSM350 MONOFAZE SANAYİ ASP.(200W 1450 DEV/DAK)	1 ad.		386,941
	080 088 000400	BSM400 MONOFAZE SANAYİ ASP.(220W 1450 DEV/DAK)	1 ad.		424,147
	080 088 000450	BSM450 MONOFAZE SANAYİ ASP.(240W 1400 DEV/DAK)	1 ad.		461,353
	080 088 000500	BSM500 MONOFAZE SANAYİ ASP.(280W 1400 DEV/DAK)	1 ad.		491,118
	080 088 000550	BSM550 MONOFAZE SANAYİ ASP.(290W 1400 DEV/DAK)	1 ad.		625,059
	080 088 000600	BSM600 MONOFAZE SANAYİ ASP.(310W 1400 DEV/DAK)	1 ad.		625,059
		TRİFAZE SANAYİ TİPİ ASPİRATÖRLER			
080 088 102250		BST250-2K TRİFAZE SANAYİ ASP.(180W 2800 DEV/DAK)	1 ad.		401,824
080 088 100250		BST250 TRİFAZE SANAYİ ASP.(100W 1400 DEV/DAK)	1 ad.		349,735
080 088 100300		BST300 TRİFAZE SANAYİ ASP.(125W 1400 DEV/DAK)	1 ad.		364,618
080 088 100350		BST350 TRİFAZE SANAYİ ASP.(175W 1400 DEV/DAK)	1 ad.		386,941
080 088 100400		BST400 TRİFAZE SANAYİ ASP.(170W 1400 DEV/DAK)	1 ad.		424,147
080 088 100450		BST450 TRİFAZE SANAYİ ASP.(210W 1400 DEV/DAK)	1 ad.		461,353
080 088 100500		BST500 TRİFAZE SANAYİ ASP.(230W 1400 DEV/DAK)	1 ad.		491,118
080 088 100550		BST550 TRİFAZE SANAYİ ASP.(220W 1400 DEV/DAK)	1 ad.		625,059
080 088 100600		BST600 TRİFAZE SANAYİ ASP.(200W 1400 DEV/DAK)	1 ad.		625,059
	AC RADYAL FANLAR (SAC GÖVDELİ)				
	080 088 012550	BDRS 125-50 AC RADYAL FAN (97W 2450 DEV/DAK)	1 ad.		282,765
	080 088 012060	BDRS 120-60 AC RADYAL FAN (90W 2400 DEV/DAK)	1 ad.		282,765
	080 088 014060	BDRS 140-60 AC RADYAL FAN (160W 2300 DEV/DAK)	1 ad.		327,412
080 088 016060	BDRS 160-60 AC RADYAL FAN (225W 2200 DEV/DAK)	1 ad.		372,059	
	AC TEK GİRİŞLİ SALYANGOZ FANLAR				
	080 088 000140	OBR140M-2K SALYANGOZ FAN (250W 2800 D/D)	1 ad.		414,118
	080 088 002200	OBR200M-2K SALYANGOZ FAN (620W 2800 D/D)	1 ad.		452,941
	080 088 002400	OBR200M-4K SALYANGOZ FAN (200W 1450 D/D)	1 ad.		452,941
	080 088 002220	OBR200T-2K SALYANGOZ FAN (600W 2800 D/D)	1 ad.		452,941
	080 088 002410	OBR200T-4K SALYANGOZ FAN (130W 1400 D/D)	1 ad.		452,941

**LED
AYDINLATMA**



LED Panel Montaj Tipleri

LED Panel Installation Types

Bu Üründe
OSRAM LED ve
PHILIPS Driver
kullanılmıştır.



Sıva Altı

Recessed LED Panel

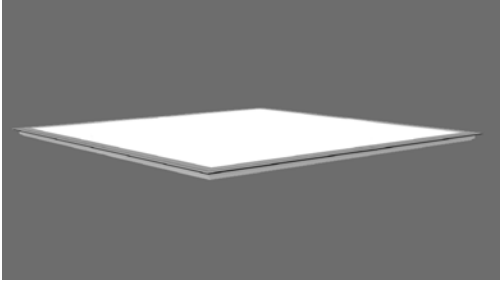

Boyut	595x595x16 mm
Ağırlık	3 kg
Giriş Voltajı	220-240 V AC - 50/60hz
Işık Kaynağı	OSRAM LED
Tüketil Gücü	35 W
Işık Renkleri	3000K, 6500K
Kullanım Ömrü	50.000 h(L ₇₀)
Ortam Sıcaklığı	-25 °C / +45 °C
Işık Akışı	3000 lm
Verimlilik	85 lm/W
Genksel Geriverim Değeri	≥ 80 (typ.85)
Garanti (Yıl)	3

KOD	AÇIKLAMA	Ambalaj	Fiyat
006 087 00 xxxx	60x60 Slim Led Panel	1 ad.	86,318 \$

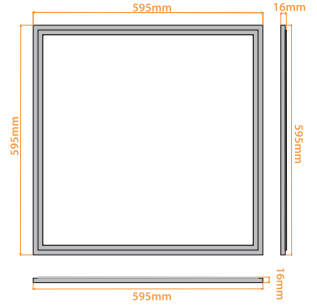

Clip-in

Clip-in



Boyut	597x597x25 mm
Ağırlık	3 kg
Giriş Voltajı	220-240 V AC - 50/60hz
Işık Kaynağı	OSRAM LED
Tüketil Gücü	35 W
Işık Renkleri	3000K, 6500K
Kullanım Ömrü	50.000 h(L ₇₀)
Ortam Sıcaklığı	-25 °C / +45 °C
Işık Akışı	3000 lm
Verimlilik	85 lm/W
Genksel Geriverim Değeri	≥ 80 (typ.85)
Garanti (Yıl)	3

KOD	AÇIKLAMA	Ambalaj	Fiyat
006 087 00 xxxx	60x60 Slim Led Panel	1 ad.	86,318 \$
999 999 999322	Clip-in Aparat 60x60	1 ad.	14,882 \$

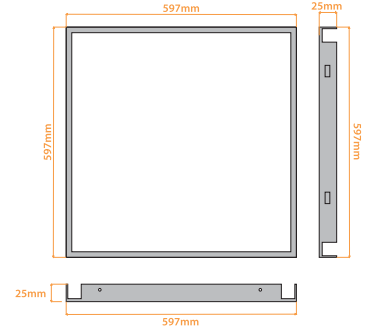

Alçı Tavan

LED Panel for gypsum ceiling



Boyut	595x595x16 mm
Ağırlık	3 kg
Giriş Voltajı	220-240 V AC - 50/60hz
Işık Kaynağı	OSRAM LED
Tüketil Gücü	35 W
Işık Renkleri	3000K, 6500K
Kullanım Ömrü	50.000 h(L ₇₀)
Ortam Sıcaklığı	-25 °C / +45 °C
Işık Akışı	3000 lm
Verimlilik	85 lm/W
Genksel Geriverim Değeri	≥ 80 (typ.85)
Garanti (Yıl)	3

KOD	AÇIKLAMA	Ambalaj	Fiyat
006 087 00 xxxx	60x60 Slim Led Panel	1 ad.	86,318 \$
999 999 999320	Alçıpan Aparat 60x60	1 ad.	8,929 \$

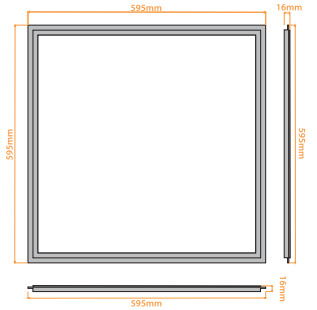

Sıva Üstü

Surface Mounted LED Panel



Boyut	597x597x50 mm
Ağırlık	3 kg
Giriş Voltajı	220-240 V AC - 50/60hz
Işık Kaynağı	OSRAM LED
Tüketil Gücü	35 W
Işık Renkleri	3000K, 6500K
Kullanım Ömrü	70.000 h(L ₇₀)
Ortam Sıcaklığı	-25 °C / +45 °C
Işık Akışı	3000 lm
Verimlilik	85 lm/W
Genksel Geriverim Değeri	≥ 80 (typ.85)
Garanti (Yıl)	3

KOD	AÇIKLAMA	Ambalaj	Fiyat
006 087 00 xxxx	60x60 Slim Led Panel	1 ad.	86,318 \$
999 999 999321	S/Ü Aparat 60x60	1 ad.	20,835 \$

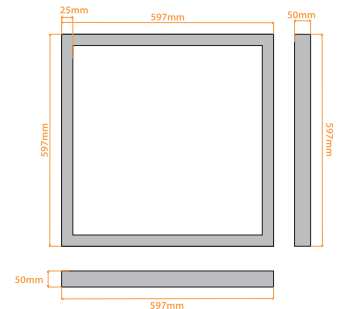

*Renk Kodu için sonu xxxx ile belirtilen kodlar için ışık renk kodunu lütfen siparişte bildiriniz.

**Aynı Markalı Ürünün 30x30 30x60 30x115 Ölçüleri Bulunmaktadır. Bu Ürünler için Fiyat İsteyiniz.



DOWNLIGHT BACKLIGHT LED ARMATÜRLER

Kod	Wat	Ölçüsü	Kelvin	Lumen	CRI	Armatür Ölçüsü(mm)	Kesim Ölçüsü(mm)	IP Sınıfı	Kutu/Koli	Fiyat
016 038 302008	8	2,5	3000	720	85+	90x25	80	20	1/40	25,60 \$
016 038 302012	12	4	3000	1116	85+	122x25	105	20	1/40	31,55 \$
016 038 302018	18	6	3000	1710	85+	175x25	155	20	1/25	35,12 \$
016 038 302023	23	8	3000	2230	85+	225x25	200	20	1/25	44,65 \$
016 038 402008	8	2,5	4000	720	85+	90x25	80	20	1/40	25,60 \$
016 038 402012	12	4	4000	1116	85+	122x25	105	20	1/40	31,55 \$
016 038 402018	18	6	4000	1710	85+	175x25	155	20	1/25	35,12 \$
016 038 402023	23	8	4000	2230	85+	225x25	200	20	1/25	44,65 \$
016 038 602008	8	2,5	6000	720	85+	90x25	80	20	1/40	25,60 \$
016 038 602012	12	4	6000	1116	85+	122x25	105	20	1/40	31,55 \$
016 038 602018	18	6	6000	1710	85+	175x25	155	20	1/25	35,12 \$
016 038 602023	23	8	6000	2230	85+	225x25	200	20	1/25	44,65 \$

ACİL KİT / RADAR SENSÖR / DALİ SİSTEM için Fiyat Alınır



Bu Üründe

LED: **OSRAM** ve **SAMSUNG**
Driver: **OSRAM** ve **PHILIPS**

BACKLIGHT
LED 30x30
ARMATÜR

30x30 LED ARMATÜR - CLIPP-IN TAVAN

Kod	Wat	Kelvin	Lumen	CRI	Armatür Ölçüsü(mm)	Kesim Ölçüsü(mm)	IP Sınıfı	Kutu/Koli	Fiyat
016 038 314030	15	3000	1515	85+	297x297x45		40	2/10	49,11 \$
016 038 314040	15	4000	1515	85+	297x297x45		40	2/10	49,11 \$
016 038 314060	15	6000	1515	85+	297x297x45		40	2/10	49,11 \$
016 038 315430	15	3000	1515	85+	297x297x45		54	2/10	62,51 \$
016 038 315440	15	4000	1515	85+	297x297x45		54	2/10	62,51 \$
016 038 315460	15	6000	1515	85+	297x297x45		54	2/10	62,51 \$

30x30 LED ARMATÜR - TAŞYÜNÜ TAVAN

Kod	Wat	Kelvin	Lumen	CRI	Armatür Ölçüsü(mm)	Kesim Ölçüsü(mm)	IP Sınıfı	Kutu/Koli	Fiyat
016 038 324030	15	3000	1515	85+	297x297x45		40	2/10	44,05 \$
016 038 324040	15	4000	1515	85+	297x297x45		40	2/10	44,05 \$
016 038 324060	15	6000	1515	85+	297x297x45		40	2/10	44,05 \$
016 038 325430	15	3000	1515	85+	297x297x45		54	2/10	57,45 \$
016 038 325440	15	4000	1515	85+	297x297x45		54	2/10	57,45 \$
016 038 325460	15	6000	1515	85+	297x297x45		54	2/10	57,45 \$

30x30 LED ARMATÜR - ALÇIPAN TAVAN

Kod	Wat	Kelvin	Lumen	CRI	Armatür Ölçüsü(mm)	Kesim Ölçüsü(mm)	IP Sınıfı	Kutu/Koli	Fiyat
016 038 334030	15	3000	1515	85+	297x297x45	275X275	40	2/10	46,14 \$
016 038 334040	15	4000	1515	85+	297x297x45	275X275	40	2/10	46,14 \$
016 038 334060	15	6000	1515	85+	297x297x45	275X275	40	2/10	46,14 \$
016 038 335430	15	3000	1515	85+	297x297x45	275X275	54	2/10	59,53 \$
016 038 335440	15	4000	1515	85+	297x297x45	275X275	54	2/10	59,53 \$
016 038 335460	15	6000	1515	85+	297x297x45	275X275	54	2/10	59,53 \$

30x30 LED ARMATÜR -SIVA ÜSTÜ

Kod	Wat	Kelvin	Lumen	CRI	Armatür Ölçüsü(mm)	Kesim Ölçüsü(mm)	IP Sınıfı	Kutu/Koli	Fiyat
016 038 344030	15	3000	1515	85+	310X310		40	2/10	52,09 \$
016 038 344040	15	4000	1515	85+	310X310		40	2/10	52,09 \$
016 038 344060	15	6000	1515	85+	310X310		40	2/10	52,09 \$
016 038 345430	15	3000	1515	85+	310X310		54	2/10	65,48 \$
016 038 345440	15	4000	1515	85+	310X310		54	2/10	65,48 \$
016 038 345460	15	6000	1515	85+	310X310		54	2/10	65,48 \$

ACİL KİT / RADAR SENSÖR / DALİ SİSTEM için Fiyat Alınır



Bu Üründe
LED: **OSRAM** ve **SAMSUNG**
Driver: **OSRAM** ve **PHILIPS**

BACKLIGHT LED 60x60 ARMATÜR

60x60 LED ARMATÜR - CLIPP-IN TAVAN

Kod	Wat	Kelvin	Lumen	CRI	Armatür Ölçüsü(mm)	Kesim Ölçüsü(mm)	IP Sınıfı	Kutu/Koli	Fiyat
016 038 614030	35	3000	3390	85+	595X595x65		40	2/8	83,34 \$
016 038 614040	35	4000	3390	85+	595X595x65		40	2/8	83,34 \$
016 038 614060	35	6000	3390	85+	595X595x65		40	2/8	83,34 \$
016 038 615430	35	3000	3390	85+	595X595x65		54	2/8	98,22 \$
016 038 615440	35	4000	3390	85+	595X595x65		54	2/8	98,22 \$
016 038 615460	35	6000	3390	85+	595X595x65		54	2/8	98,22 \$

60x60 LED ARMATÜR - TAŞYÜNÜ TAVAN

Kod	Wat	Kelvin	Lumen	CRI	Armatür Ölçüsü(mm)	Kesim Ölçüsü(mm)	IP Sınıfı	Kutu/Koli	Fiyat
016 038 624030	35	3000	3390	85+	595X595x65		40	2/8	69,95 \$
016 038 624040	35	4000	3390	85+	595X595x65		40	2/8	69,95 \$
016 038 624060	35	6000	3390	85+	595X595x65		40	2/8	69,95 \$
016 038 625430	35	3000	3390	85+	595X595x65		54	2/8	86,32 \$
016 038 625440	35	4000	3390	85+	595X595x65		54	2/8	86,32 \$
016 038 625460	35	6000	3390	85+	595X595x65		54	2/8	86,32 \$

60x60 LED ARMATÜR - ALÇIPAN TAVAN

Kod	Wat	Kelvin	Lumen	CRI	Armatür Ölçüsü(mm)	Kesim Ölçüsü(mm)	IP Sınıfı	Kutu/Koli	Fiyat
016 038 634030	35	3000	3390	85+	595X595x65	575X575	40	2/8	74,41 \$
016 038 634040	35	4000	3390	85+	595X595x65	575X575	40	2/8	74,41 \$
016 038 634060	35	6000	3390	85+	595X595x65	575X575	40	2/8	74,41 \$
016 038 635430	35	3000	3390	85+	595X595x65	575X575	54	2/8	89,29 \$
016 038 635440	35	4000	3390	85+	595X595x65	575X575	54	2/8	89,29 \$
016 038 635460	35	6000	3390	85+	595X595x65	575X575	54	2/8	89,29 \$

60x60 LED ARMATÜR - SIVA ÜSTÜ

Kod	Wat	Kelvin	Lumen	CRI	Armatür Ölçüsü(mm)	Kesim Ölçüsü(mm)	IP Sınıfı	Kutu/Koli	Fiyat
016 038 644030	35	3000	3390	85+	610X610x75		40	2/4	87,81 \$
016 038 644040	35	4000	3390	85+	610X610x75		40	2/4	87,81 \$
016 038 644060	35	6000	3390	85+	610X610x75		40	2/4	87,81 \$
016 038 645430	35	3000	3390	85+	610X610x75		54	2/4	101,20 \$
016 038 645440	35	4000	3390	85+	610X610x75		54	2/4	101,20 \$
016 038 645460	35	6000	3390	85+	610X610x75		54	2/4	101,20 \$

ACİL KİT / RADAR SENSÖR / DALİ SİSTEM için Fiyat Alınız



Bu Üründe
LED: **OSRAM** ve **SAMSUNG**
Driver: **OSRAM** ve **PHILIPS**

BACKLIGHT HYGIENE BACKLIGHT 60x60

60x60 HYGIENE BACKLIGHT LED ARMATÜR

Kod	Wat	Kelvin	Lumen	CRI	Armatür Ölçüsü(mm)	Kesim Ölçüsü(mm)	IP Sınıfı	Kutu/Koli	Fiyat
016 038 755470	42	3000	4000	85+	595X595X82	575X575	65	2/4	223,24 \$
016 038 755480	42	4000	4000	85+	595X595X82	575X575	65	2/4	223,24 \$
016 038 755490	42	6000	4000	85+	595X595X82	575X575	65	2/4	223,24 \$

ACİL KİT / RADAR SENSÖR / DALİ SİSTEM için Fiyat Alınız



60 CM MONOBLOK POLİKARBON GÖVDE VE CAM ETANJ ARMATÜR

Kod	Wat	Kelvin	Lümen	CRI	Armatür Ölç. mm	IP Sınıfı	Adet	Fiyat
090 038 600500	17	3000	1826	85	83-600-87	65	1	50,60 \$
090 038 600501	17	4000	1826	85	83-600-87	65	1	50,60 \$
090 038 600502	17	6000	1826	85	83-600-87	65	1	50,60 \$

90 CM MONOBLOK POLİKARBON GÖVDE VE CAM ETANJ ARMATÜR

Kod	Wat	Kelvin	Lümen	CRI	Armatür Ölç. mm	IP Sınıfı	Adet	Fiyat
090 038 900258	25	3000	2739	85	83-900-87	65	1	56,55 \$
090 038 900259	25	4000	2739	85	83-900-87	65	1	56,55 \$
090 038 900260	25	6000	2739	85	83-900-87	65	1	56,55 \$

120 CM MONOBLOK POLİKARBON GÖVDE VE CAM ETANJ ARMATÜR

Kod	Wat	Kelvin	Lümen	CRI	Armatür Ölç. mm	IP Sınıfı	Adet	Fiyat
090 038 120259	34	3000	3652	85	83-1200-87	65	1	65,48 \$
090 038 120260	34	4000	3652	85	83-1200-87	65	1	65,48 \$
090 038 120261	34	6000	3652	85	83-1200-87	65	1	65,48 \$

150 CM MONOBLOK POLİKARBON GÖVDE VE CAM ETANJ ARMATÜR

Kod	Wat	Kelvin	Lümen	CRI	Armatür Ölç. mm	IP Sınıfı	Adet	Fiyat
090 038 150500	42	3000	4564	85	83-1500-87	65	1	80,36 \$
090 038 150501	42	4000	4564	85	83-1500-87	65	1	80,36 \$
090 038 150502	42	6000	4564	85	83-1500-87	65	1	80,36 \$



Bu Üründe
LED: **OSRAM** ve **SAMSUNG**
Driver: **OSRAM** ve **PHILIPS**

ALÜMİNYUM
GÖVDE
PC CAM
LED ETANJ ARMATÜR



60 CM ALÜMİNYUM GÖVDE ve PC CAM LED ETANJ ARMATÜRLER

Kod	Wat	Kelvin	Lumen	CRI	Armatür Ölçüsü(mm)	IP Sınıfı	Kutu/Koli	Fiyat
016 038 705430	10	3000	950	85+	600X85x115	54	1	62,51 \$
016 038 705440	10	4000	950	85+	600X85x115	54	1	62,51 \$
016 038 705460	10	6000	950	85+	600X85x115	54	1	62,51 \$
016 038 715430	20	3000	1900	85+	600X85x115	54	1	68,46 \$
016 038 715440	20	4000	1900	85+	600X85x115	54	1	68,46 \$
016 038 715460	20	6000	1900	85+	600X85x115	54	1	68,46 \$

120 CM ALÜMİNYUM GÖVDE ve PC CAM LED ETANJ ARMATÜRLER

Kod	Wat	Kelvin	Lumen	CRI	Armatür Ölçüsü(mm)	IP Sınıfı	Kutu/Koli	Fiyat
016 038 725430	20	3000	1900	85+	1200X85x115	54	1	89,29 \$
016 038 725440	20	4000	1900	85+	1200X85x115	54	1	89,29 \$
016 038 725460	20	6000	1900	85+	1200X85x115	54	1	89,29 \$
016 038 735430	40	3000	3800	85+	1200X85x115	54	1	104,18 \$
016 038 735440	40	4000	3800	85+	1200X85x115	54	1	104,18 \$
016 038 735460	40	6000	3800	85+	1200X85x115	54	1	104,18 \$

150 CM ALÜMİNYUM GÖVDE ve PC CAM LED ETANJ ARMATÜRLER

Kod	Wat	Kelvin	Lumen	CRI	Armatür Ölçüsü(mm)	IP Sınıfı	Kutu/Koli	Fiyat
016 038 745430	40	3000	3800	85+	1500X85x115	54	1	113,11 \$
016 038 745440	40	4000	3800	85+	1500X85x115	54	1	113,11 \$
016 038 745460	40	6000	3800	85+	1500X85x115	54	1	113,11 \$
016 038 755430	50	3000	4700	85+	1500X85x115	54	1	127,99 \$
016 038 755440	50	4000	4700	85+	1500X85x115	54	1	127,99 \$
016 038 755460	50	6000	4700	85+	1500X85x115	54	1	127,99 \$

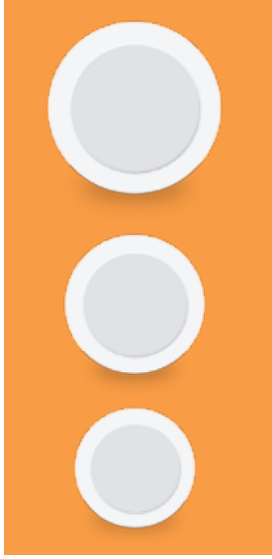

SIVA ALTI YUVARLAK SLİM LED PANELLER

Kod	Wat	Kelvin	Lümen	CRI	Arm. Ölç. (mm)	Kes. Ölç. (mm)	Kutu/Koli	Fiyat
016 242 000970	3	3000	300	>80	20x85	70	1/100	3,00 \$
016 242 000975	3	4000	300	>80	20x85	70	1/100	3,00 \$
016 242 000980	3	6000	300	>80	20x85	70	1/100	3,00 \$
016 242 000990	6	3000	600	>80	20x120	105	1/100	4,53 \$
016 242 000995	6	4000	600	>80	20x120	105	1/100	4,53 \$
016 242 001000	6	6000	600	>80	20x120	105	1/100	4,53 \$
016 242 001010	9	3000	900	>80	20x146	130	1/60	5,60 \$
016 242 001015	9	4000	900	>80	20x146	130	1/60	5,60 \$
016 242 001020	9	6000	900	>80	20x146	130	1/60	5,60 \$
016 242 001030	12	3000	1200	>80	20x170	155	1/40	7,09 \$
016 242 001035	12	4000	1200	>80	20x170	155	1/40	7,09 \$
016 242 001040	12	6000	1200	>80	20x170	155	1/40	7,09 \$
016 242 001050	15	3000	1500	>80	20x190	175	1/40	7,88 \$
016 242 001055	15	4000	1500	>80	20x190	175	1/40	7,88 \$
016 242 001060	15	6000	1500	>80	20x190	175	1/40	7,88 \$
016 242 001070	18	3000	1800	>80	20x220	205	1/20	8,66 \$
016 242 001075	18	4000	1800	>80	20x220	205	1/20	8,66 \$
016 242 001080	18	6000	1800	>80	20x220	205	1/20	8,66 \$
016 242 001090	24	3000	2400	>80	20x300	280	1/10	17,83 \$
016 242 001095	24	4000	2400	>80	20x300	280	1/10	17,83 \$
016 242 001100	24	6000	2400	>80	20x300	280	1/10	17,83 \$

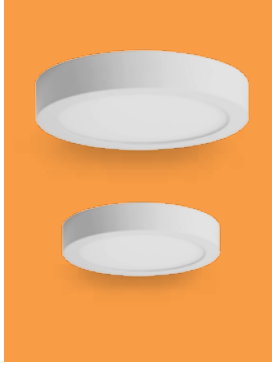

SIVA ÜSTÜ YUVARLAK LED PANELLER

Kod	Wat	Kelvin	Lümen	CRI	Arm. Ölçüsü (mm)	Kutu/Koli	Fiyat
016 242 001420	6	3000	600	>80	30x120	1/60	6,05 \$
016 242 001425	6	4000	600	>80	30x120	1/60	6,05 \$
016 242 001430	6	6000	600	>80	30x120	1/60	6,05 \$
016 242 001440	12	3000	1200	>80	30x174	1/40	8,88 \$
016 242 001445	12	4000	1200	>80	30x174	1/40	8,88 \$
016 242 001450	12	6000	1200	>80	30x174	1/40	8,88 \$
016 242 001550	18	3000	1800	>80	30x220	1/20	14,23 \$
016 242 001555	18	4000	1800	>80	30x220	1/20	14,23 \$
016 242 001560	18	6000	1800	>80	30x220	1/20	14,23 \$
016 242 001170	24	3000	2400	>80	30x300	1/10	18,05 \$
016 242 001175	24	4000	2400	>80	30x300	1/10	18,05 \$
016 242 001180	24	6000	2400	>80	30x300	1/10	18,05 \$



LED PROJKTÖRLER

Kod	Wat	Kelvin	Lümen	CRI	Kutu/Koli	Fiyat
016 302 001600	20	6000	2000	>80	1/24	12,34 \$
016 302 001630	30	6000	3000	>80	1/24	18,98 \$
016 302 001660	50	6000	5000	>80	1/12	25,87 \$
016 302 001690	80	6000	8000	>80	1/10	47,65 \$
016 302 001720	100	6000	10000	>80	1/10	60,00 \$
016 302 001750	150	6000	15000	>80	1/5	100,00 \$
016 302 001780	200	6000	20000	>80	1/5	135,00 \$



KOD	AÇIKLAMA	BOYUT	LUMEN	GÜÇ	IŞIK SICAKLIĞI	AMBALAJ	FİYAT
016 040 100001	Wallwasher 12 Ledli	35 cm	900 lm	12W	3000K	1ad.	71,882 \$
016 040 100002	Wallwasher 12 Ledli	35 cm	963 lm	12W	6500K	1ad.	71,882 \$
016 040 100003	Wallwasher 18 Ledli	50 cm	1550 lm	18W	3000K	1ad.	98,581 \$
016 040 100004	Wallwasher 18 Ledli	50 cm	1605 lm	18W	6500K	1ad.	98,581 \$
016 040 100005	Wallwasher 36 Ledli	100 cm	3000 lm	32W	3000K	1ad.	159,167 \$
016 040 100006	Wallwasher 36 Ledli	100 cm	3210 lm	32W	6500K	1ad.	159,167 \$

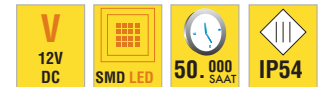

KOD	AÇIKLAMA	BOYUT	GÜÇ	IŞIK SICAKLIĞI	AMBALAJ	FİYAT
016 040 200001	Led Bar (Led Trafosu Hariç)	25 cm	4W	3500K	1ad.	7,496 \$
016 040 200002	Led Bar (Led Trafosu Hariç)	25 cm	4W	6000K	1ad.	7,496 \$
016 040 200003	Led Bar (Led Trafosu Hariç)	50 cm	7,5W	3500K	1ad.	12,990 \$
016 040 200004	Led Bar (Led Trafosu Hariç)	50 cm	7,5W	6000K	1ad.	12,990 \$
016 040 200005	Led Bar (Led Trafosu Hariç)	75 cm	10,5W	3500K	1ad.	20,743 \$
016 040 200006	Led Bar (Led Trafosu Hariç)	75 cm	10,5W	6000K	1ad.	20,743 \$
016 040 200007	Led Bar (Led Trafosu Hariç)	100 cm	15W	3500K	1ad.	22,694 \$
016 040 200008	Led Bar (Led Trafosu Hariç)	100 cm	15W	6000K	1ad.	22,694 \$



36 W UFO LED AMPUL

Kod	: 016 038 001063
Wat	: 36
Kelvin	: 6400
Lümen	: 2400
Kutu/Koli	: 1/12
Fiyat	: 66,971



24 W SİMİT LED ARMATÜR

Kod	: 016 038 001059
Wat	: 24
Kelvin	: 6400
Lümen	: 2400
Kutu/Koli	: 1/24
Fiyat	: 66,971



36 W E27 LED AMPUL

Kod	: 016 038 001058
Wat	: 36
Kelvin	: 6400
Lümen	: 3800
Kutu/Koli	: 1/24
Fiyat	: 66,971



5 W LED SPOT

Kod	Wat	Kelvin	Lümen	Kutu/Koli		
016 038 001060	5	BEYAZ	6400	500	1/24	11,162
016 038 002060	5	ALTIN	6400	500	1/24	14,138
016 038 003060	5	KROM	6400	500	1/24	14,138
016 038 004060	5	CEVİZ	6400	500	1/24	14,138



Radar Sensörlü



YENİ
ÜRÜNLERİMİZ

LED Mikrodalga (Radar) Sensörlü Tavan Aydınlatma

Güç: 15W

Çalışma Voltajı: 85V-270V

Ölçü(MM) :260 MM

Metal Taban / Plastik Gövde

LED :SMD 57/30

Lümen: 900-980 lm

Renk :6500k

Çalışma süresi : 50 000h

Radar sensörü Algılama : Çap: = 10-12 M

Yüksek duyarlılık

Çalışma açısı :180° x 360°

KOLİ ADEDİ : 20

Fiyat:
124,268 TL



Ürün Kodu: 016 038 250081

Ürün Adı : Radar Sens. Led Arm Sofia-1

Ürün Kodu: 016 038 250082

Ürün Adı : Radar Sens. Led Arm Sofia-2



Ürün Kodu: 016 038 250083

Ürün Adı : Radar Sens. Led Arm Sofia-3

Ürün Kodu: 016 038 250084

Ürün Adı : Radar Sens. Led Arm Sofia-4

LED Tavan Aydınlatma

Metal Taban / Plastik Gövde

Güç: 15W

Çalışma Voltajı: 85V-270V

Ölçü(MM) :260 MM

LED :SMD 57/30

Lümen: 900-980 lm

Renk :6500k

Çalışma süresi : 50 000 S

KOLİ ADEDİ : 20

Fiyat:
90,782 TL



Ürün Kodu: 016 038 250071

Ürün Adı : Led Aydınlatma Sidem-1

Ürün Kodu: 016 038 250072

Ürün Adı : Led Aydınlatma Sidem-2



Ürün Kodu: 016 038 250073

Ürün Adı : Led Aydınlatma Sidem-3

Ürün Kodu: 016 038 250074

Ürün Adı : Led Aydınlatma Sidem-4

AYDINLATMA ÜRÜNLERİ





Kod	Açıklama / Stok Cinsi	Amb. (Kutu/Bağ)	Amb. (Koli/Çift)	FİYAT
ETANJ ARMATÜRLER AKRİLİK CAM-PC GÖVDE (MEKANİK BALANSTLI)				
066 038 910118	T-2000-04 1X18 ETANJ ARMATÜR(AKRİLİK CAM)(MEKANİK BALANS)	2 ad.	12	71,598
066 038 910218	T-2000-03 2X18 ETANJ ARMATÜR (AKRİLİK CAM)(MEKANİK BALANS)	2 ad.	12	74,439
066 038 910136	T-2000-02 1X36 ETANJ ARMATÜR (AKRİLİK CAM)(MEKANİK BALANS)	2 ad.	12	79,553
066 038 910236	T-2000-01 2X36 ETANJ ARMATÜR (AKRİLİK CAM)(MEKANİK BALANS)	2 ad.	12	100,862
ETANJ ARMATÜRLER AKRİLİK CAM-PC GÖVDE (ELEKTRONİK BALANSTLI)				
090 038 190136	T-2000-02 1X36 ETANJ ARMATÜR (ELEKTRONİK BALANSTLI)	2 ad.	12	92,338
090 038 190236	T-2000-01 2X36 ETANJ ARMATÜR ELEKTRONİK BALANSTLI)	2 ad.	12	99,441
ETANJ ARMATÜRLER PC CAM-PC GÖVDE (MEKANİK BALANSTLI)				
090 038 210118	TIBA-118 1X18 W ETANJ ARMATÜR PC(MEKANİK BALANSTLI)	2 ad.	12	75,291
090 038 210136	TIBA-136 1X36 W ETANJ ARMATÜR PC(MEKANİK BALANSTLI)	2 ad.	12	89,497
090 038 210218	TIBA-218 2X18 W ETANJ ARMATÜR PC(MEKANİK BALANSTLI)	2 ad.	12	83,815
090 038 210236	TIBA-236 2X36 W ETANJ ARMATÜR PC(MEKANİK BALANSTLI)	2 ad.	12	112,226
ETANJ ARMATÜRLER PC CAM-PC GÖVDE (ELEKTRONİK BALANSTLI)				
090 038 120118	TIBA-118 1X18 IP 65 ETANJ ARMATÜR (ELEKTRONİK BALANSTLI)	2 ad.	12	83,815
090 038 120218	TIBA-218 2X18 IP 65 ETANJ ARMATÜR (ELEKTRONİK BALANSTLI)	2 ad.	12	90,918
090 038 120136	TIBA-136 1X36 IP 65 ETANJ ARMATÜR (ELEKTRONİK BALANSTLI)	2 ad.	12	95,179
090 038 120236	TIBA-236 2X36 IP 65 ETANJ ARMATÜR (ELEKTRONİK BALANSTLI)	2 ad.	12	123,591
ETANJ ARMATÜRLER PC CAM-PC GÖVDE (OSRAM ELEKTRONİK BALANSTLI)				
090 038 220118	TIBA-118 1X18 W ETANJ ARMATÜR PC (OSRAM ELEKTRONİK BALANSTLI)	2 ad.	12	105,124
090 038 220136	TIBA-136 1X36 W ETANJ ARMATÜR PC (OSRAM ELEKTRONİK BALANSTLI)	2 ad.	12	133,535
090 038 220218	TIBA-218 2X18 W ETANJ ARMATÜR PC (OSRAM ELEKTRONİK BALANSTLI)	2 ad.	12	125,012
090 038 220236	TIBA-236 2X36 W ETANJ ARMATÜR PC (OSRAM ELEKTRONİK BALANSTLI)	2 ad.	12	140,638

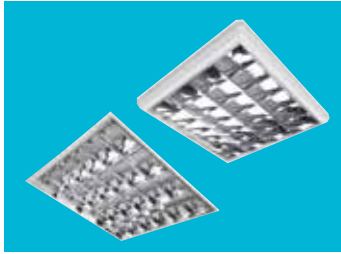

T 8 S/Ü ÇİFTPARABOLİK ARMATÜRLER (MEKANİK BALANSTLI)				
090 039 171218	2X18 W S/Ü ÇİFT PARABOLİK ARMATÜR	1	ad.	90,918
090 039 151418	4X18 W S/Ü ÇİFT PARABOLİK ARMATÜR	1	ad.	136,376
090 039 171236	2X36 W S/Ü ÇİFT PARABOLİK ARMATÜR	1	ad.	136,376
T 8 S/A ÇİFTPARABOLİK ARMATÜRLER (MEKANİK BALANSTLI)				
090 039 161218	2X18 W S/A ÇİFT PARABOLİK ARMATÜR	1	ad.	90,918
090 039 141418	4X18 W S/A ÇİFT PARABOLİK ARMATÜR	1	ad.	136,376
090 039 161236	2X36 W S/A ÇİFT PARABOLİK ARMATÜR	1	ad.	136,376



BATTEN TMS BANT TİPİ T8 LAMBALI ARMATÜR (MEKANİK BALANSTLI)				
078 038 900118	1x18 W BATTEN TMS BANT TİPİ T8 LAMBALI ARMATÜR (MEKANİK BALANSTLI)	1 ad.	6	31,821
078 038 900136	1x36 W BATTEN TMS BANT TİPİ T8 LAMBALI ARMATÜR (MEKANİK BALANSTLI)	1 ad.	6	40,487
078 038 900218	2x18 W BATTEN TMS BANT TİPİ T8 LAMBALI ARMATÜR (MEKANİK BALANSTLI)	1 ad.	6	36,083
078 038 900236	2x36 W BATTEN TMS BANT TİPİ T8 LAMBALI ARMATÜR (MEKANİK BALANSTLI)	1 ad.	6	57,676



T 8 S/Ü ÇİFTPARABOLİK ARMATÜRLER (ELEKTRONİK BALANSTLI)				
090 038 000118	TIL-118-SM S/Ü 1X18 ÇİFTPARABOLİK ARMATÜR (ELEKTRONİK BALANSTLI)	1	ad.	110,806
090 038 000218	TIL-218-SM S/Ü 2X18 ÇİFTPARABOLİK ARMATÜR (ELEKTRONİK BALANSTLI)	1	ad.	122,171
090 038 000418	TIL-418-SM S/Ü 4X18 ÇİFTPARABOLİK ARMATÜR (ELEKTRONİK BALANSTLI)	1	ad.	161,947
090 038 000136	TIL-136-SM S/Ü 1X36 ÇİFTPARABOLİK ARMATÜR (ELEKTRONİK BALANSTLI)	1	ad.	130,694
090 038 000236	TIL-236-SM S/Ü 2X36 ÇİFTPARABOLİK ARMATÜR (ELEKTRONİK BALANSTLI)	1	ad.	161,947
T 8 S/A ÇİFTPARABOLİK ARMATÜRLER (ELEKTRONİK BALANSTLI)				
090 038 100118	TIL-118-RM S/A 1X18 ÇİFTPARABOLİK ARMATÜR (ELEKTRONİK BALANSTLI)	1	ad.	110,806
090 038 100218	TIL-218-RM S/A 2X18 ÇİFTPARABOLİK ARMATÜR (ELEKTRONİK BALANSTLI)	1	ad.	122,171
090 038 100418	TIL-418-RM S/A 4X18 ÇİFTPARABOLİK ARMATÜR (ELEKTRONİK BALANSTLI)	1	ad.	161,947
090 038 100136	TIL-136-RM S/A 1X36 ÇİFTPARABOLİK ARMATÜR (ELEKTRONİK BALANSTLI)	1	ad.	130,694
090 038 100236	TIL-236-RM S/A 2X36 ÇİFTPARABOLİK ARMATÜR (ELEKTRONİK BALANSTLI)	1	ad.	161,947



İTHAL PROJEKTÖRLER				
888 038 273150	150 W PROJEKTÖR (NORMAL)	1	ad.	44,647
888 038 273500	500 W PROJEKTÖR (NORMAL)	1	ad.	56,553
888 038 273100	1000 W PROJEKTÖR (NORMAL)	1	ad.	98,224

ARMATÜR Çeşitleri





NEMLİYER ARMATÜR ÇEŞİTLERİ



ÜRÜN KODU
016 038 700511
ÜRÜN ADI
NEMLİYER ALÜMİNYUM
KFS. CAM ARM. (SİYAH)
AMBALAJ ADET / KOLİ
1/20
FİYAT
34,094 TL



ÜRÜN KODU
016 038 411100
ÜRÜN ADI
AQUA KAFESLİ APLİK
(BEYAZ) IP54
AMBALAJ ADET / KOLİ
1/20
FİYAT
13,496 TL

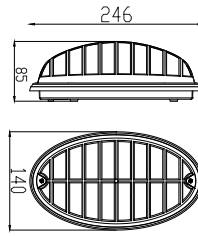

ÜRÜN KODU
016 038 411111
ÜRÜN ADI
AQUA KAFESLİ APLİK
(SİYAH) IP54
AMBALAJ ADET / KOLİ
1/20
FİYAT
13,496 TL



ÜRÜN KODU
016 038 411300
ÜRÜN ADI
OPAK KAFESLİ ARMATÜR
(BEYAZ) IP54
AMBALAJ ADET / KOLİ
1/24
FİYAT
13,496 TL

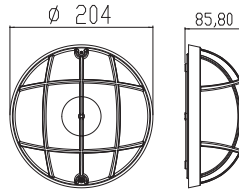

ÜRÜN KODU
016 038 411311
ÜRÜN ADI
OPAK KAFESLİ ARMATÜR
(SİYAH) IP54
AMBALAJ ADET / KOLİ
1/24
FİYAT
13,496 TL



ÜRÜN KODU
016 038 410600
ÜRÜN ADI
ELİPS OPAL ARMATÜR
(BEYAZ) IP65
AMBALAJ ADET / KOLİ
1/10
FİYAT
28,412 TL

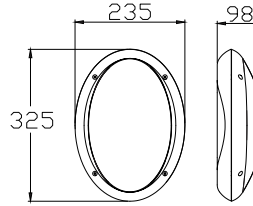

ÜRÜN KODU
016 038 410611
ÜRÜN ADI
ELİPS OPAL ARMATÜR
(SİYAH) IP65
AMBALAJ ADET / KOLİ
1/10
FİYAT
28,412 TL



ÜRÜN KODU
016 038 410500
ÜRÜN ADI
OPAL ARMATÜR
(BEYAZ) IP65
AMBALAJ ADET / KOLİ
1/10
FİYAT
28,412 TL

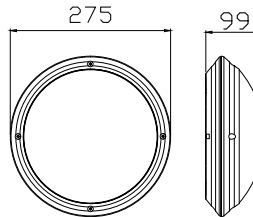

ÜRÜN KODU
016 038 410511
ÜRÜN ADI
OPAL ARMATÜR
(SİYAH) IP65
AMBALAJ ADET / KOLİ
1/10
FİYAT
28,412 TL





NEMLİYER ARMATÜR ÇEŞİTLERİ



ÜRÜN KODU
016 038 700100
ÜRÜN ADI
DOLUNAY OPAK ARMATÜR
(BEYAZ) IP54
AMBALAJ ADET / KOLİ
1/10
FİYAT
18,894 TL

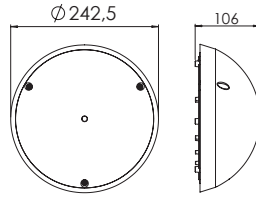

ÜRÜN KODU
016 038 700111
ÜRÜN ADI
DOLUNAY OPAK ARMATÜR
(SİYAH) IP54
AMBALAJ ADET / KOLİ
1/10
FİYAT
18,894 TL



ÜRÜN KODU
016 038 700200
ÜRÜN ADI
DOLUNAY ŞEFFAF
ARMATÜR (BEYAZ) IP54
AMBALAJ ADET / KOLİ
1/10
FİYAT
18,894 TL

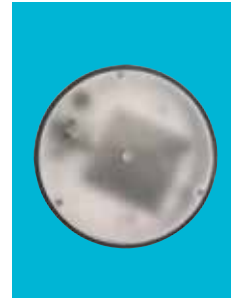
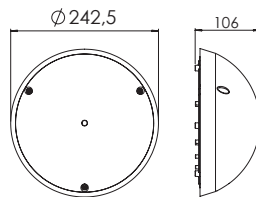

ÜRÜN KODU
016 038 700211
ÜRÜN ADI
DOLUNAY ŞEFFAF
ARMATÜR (SİYAH) IP54
AMBALAJ ADET / KOLİ
1/10
FİYAT
18,894 TL



ÜRÜN KODU
016 038 700300
ÜRÜN ADI
DOLUNAY OPAK APLİK
(BEYAZ) IP54
AMBALAJ ADET / KOLİ
1/20
FİYAT
18,894 TL

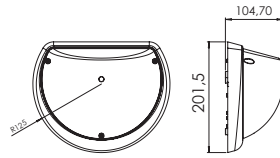

ÜRÜN KODU
016 038 700311
ÜRÜN ADI
DOLUNAY OPAK APLİK
(SİYAH) IP54
AMBALAJ ADET / KOLİ
1/20
FİYAT
18,894 TL



ÜRÜN KODU
016 038 700400
ÜRÜN ADI
DOLUNAY ŞEFFAF APLİK
(BEYAZ) IP54
AMBALAJ ADET / KOLİ
1/20
FİYAT
18,894 TL

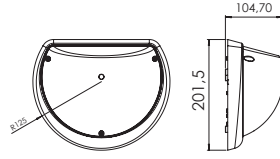

ÜRÜN KODU
016 038 700411
ÜRÜN ADI
DOLUNAY ŞEFFAF APLİK
(SİYAH) IP54
AMBALAJ ADET / KOLİ
1/20
FİYAT
18,894 TL



ÜRÜN KODU
016 038 410800
ÜRÜN ADI
OPAK ARMATÜR
(BEYAZ) IP54
AMBALAJ ADET / KOLİ
1/16
FİYAT
18,041 TL

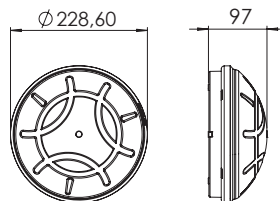

ÜRÜN KODU
016 038 410811
ÜRÜN ADI
OPAK ARMATÜR
(SİYAH) IP54
AMBALAJ ADET / KOLİ
1/16
FİYAT
18,041 TL



ARMATÜR ÇEŞİTLERİ



ÜRÜN KODU
016 038 250028
ÜRÜN ADI
OVAL DÜZ
ARMATÜR
AMBALAJ ADET / KOLİ
48
FİYAT
8,697 TL



ÜRÜN KODU
016 038 270001
ÜRÜN ADI
LEDLİ OVAL KAFESLİ
ARMATÜR
AMBALAJ ADET / KOLİ
20
FİYAT
44,647 TL



ÜRÜN KODU
016 038 250029
ÜRÜN ADI
OVAL KAFESLİ
ARMATÜR
AMBALAJ ADET / KOLİ
48
FİYAT
9,013 TL



ÜRÜN KODU
016 038 501018
ÜRÜN ADI
POLİKARBON GÖVDE
KAFESLİ CAM ARMATÜR IP40
AMBALAJ ADET / KOLİ
2/20
FİYAT
26,707 TL



ÜRÜN KODU
001 038 150101 00 00
ÜRÜN ADI
BEGONYA NEMLİYER
TAVAN ARMATÜRÜ (KLASİK)
AMBALAJ ADET / KOLİ
12
FİYAT
20,057 TL



ÜRÜN KODU
016 038 500017
ÜRÜN ADI
POLİKARBON GÖVDE
KAFESLİ CAM ARMATÜR IP40
AMBALAJ ADET / KOLİ
2/20
FİYAT
23,866 TL



ÜRÜN KODU
001 038 130101 00 00
ÜRÜN ADI
BEGONYA NEMLİYER
TAVAN ARMATÜRÜ (DİKEY)
AMBALAJ ADET / KOLİ
12
FİYAT
21,184 TL



ÜRÜN KODU
016 038 502018
ÜRÜN ADI
POLİKARBON GÖVDE TEL
KAFESLİ CAM ARM. IP 40
AMBALAJ ADET / KOLİ
2/20
FİYAT
41,481 TL



ÜRÜN KODU
001 038 140101 00 00
ÜRÜN ADI
BEGONYA NEMLİYER
TAVAN ARMATÜRÜ (YATAY)
AMBALAJ ADET / KOLİ
12
FİYAT
21,785 TL



ARMATÜR ÇEŞİTLERİ



ÜRÜN KODU
016 038 250013
ÜRÜN ADI
DUVAR APLİK
(KRALİÇE)
AMBALAJ ADET / KOLİ
12/48
FİYAT
7,387 TL



ÜRÜN KODU
001 038 090101 00 00
ÜRÜN ADI
YASEMİN DUVAR
APLİK
AMBALAJ ADET / KOLİ
2/24
FİYAT
12,146 TL



ÜRÜN KODU
078 039 100005
ÜRÜN ADI
NERGİS APLİK
AMBALAJ ADET / KOLİ
8/64
FİYAT
9,802 TL



ÜRÜN KODU
001 038 080101 00 00
ÜRÜN ADI
YASEMİN OVAL
ARMATÜR
AMBALAJ ADET / KOLİ
2/24
FİYAT
12,311 TL



ÜRÜN KODU
001 038 020201 00 00
ÜRÜN ADI
FULYA DUVAR APLİK
AMBALAJ ADET / KOLİ
2/20
FİYAT
9,859 TL



ÜRÜN KODU
001 038 190201 00 00
ÜRÜN ADI
PİRAMİT APLİK
AMBALAJ ADET / KOLİ
24
FİYAT
12,885 TL



ÜRÜN KODU
001 038 010201 00 00
ÜRÜN ADI
MANOLYA DUVAR
APLİK
AMBALAJ ADET / KOLİ
2/20
FİYAT
10,762 TL

Kod	Açıklama / Stok Cinsi	Amb. (Kutu)	Amb. Birimi	FİYAT
T-5 LEDLİ ARMATÜRLER				
102 038 518012	CLAT 5-18 W (51 CM)(12V)	1	ad.	48,300
102 038 518220	CLAT 5-18 W (51 CM)(220V)	1	ad.	52,562
102 038 513012	CLAT 5-13 W (31 CM)(12V)	1	ad.	36,935
102 038 513220	CLAT 5-13 W (31 CM)(220V)	1	ad.	41,197
102 038 510812	CLAT 5-8 W (25 CM)(12V)	1	ad.	32,674
102 038 508220	CLAT 5-8 W (25 CM)(220V)	1	ad.	36,935
MUTLUSAN İTHAL ÜRÜNLERİMİZ				
888 038 000328	L 328 LEDLİ KLASİK GECE LAMBASI AC 230V	10	ad.	3,374 \$
888 038 000368	L 368 LEDLİ ÇOCUK GECE LAMBASI AC230V	10	ad.	3,374 \$
888 038 000378	L 378 LEDLİ KELEBEK GECE LAMBASI AC230V	10	ad.	3,335 \$
888 038 000388	L 388 LEDLİ ÇİÇEK GECE LAMBASI AC230V	10	ad.	3,335 \$



ARMATÜR ÇEŞİTLERİ



ÜRÜN KODU
001 038 250018 00 00
ÜRÜN ADI
HAZIR ASKI TİJ
TAKIMI
AMBALAJ ADET / KOLİ
25/500
FİYAT
2,170 TL



ÜRÜN KODU
001 038 010101 00 00
ÜRÜN ADI
MANOLYA TAVAN
ARMATÜRÜ
AMBALAJ ADET / KOLİ
5
FİYAT
15,706 TL



ÜRÜN KODU
001 038 250019 00 00
ÜRÜN ADI
HAZIR ASKI TİJ
TAKIMI(MUHAFAZALI)
AMBALAJ ADET / KOLİ
25/500
FİYAT
2,464 TL



ÜRÜN KODU
001 038 110101 00 00
ÜRÜN ADI
MERVE TAVAN
ARMATÜRÜ
AMBALAJ ADET / KOLİ
5
FİYAT
17,737 TL



ÜRÜN KODU
001 038 250016 00 00
ÜRÜN ADI
PAPATYA HAZIR ASKI
TİJ TAKIMI
AMBALAJ ADET / KOLİ
25/275
FİYAT
2,379 TL



ÜRÜN KODU
001 038 020101 00 00
ÜRÜN ADI
FULYA TAVAN
ARMATÜRÜ
AMBALAJ ADET / KOLİ
5
FİYAT
16,837 TL



ÜRÜN KODU
001 038 250017 00 00
ÜRÜN ADI
BÜYÜK PAPATYA HAZIR
ASKI TİJ TAKIMI
AMBALAJ ADET / KOLİ
10/80
FİYAT
3,907 TL



ÜRÜN KODU
001 038 180101 00 00
ÜRÜN ADI
AKASYA TAVAN
ARMATÜRÜ
AMBALAJ ADET / KOLİ
5
FİYAT
16,592 TL



ÜRÜN KODU
078 039 100006
ÜRÜN ADI
ÇİFT DUYLU TAVAN
ARMATÜR
AMBALAJ ADET / KOLİ
2/32
FİYAT
18,468 TL

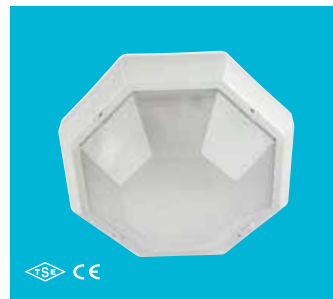

ÜRÜN KODU
001 038 170101 00 00
ÜRÜN ADI
KAMELYA TAVAN
ARMATÜRÜ
AMBALAJ ADET / KOLİ
5
FİYAT
22,025 TL

CAM ARMATÜR ÇEŞİTLERİ



ÜRÜN KODU
079 039 140003
ÜRÜN ADI
DEKORATİF CAM ARMATÜR
ÇİFT DUYLU (BEYAZ)
AMBALAJ ADET / KOLİ
12
FİYAT
51,141 TL



ÜRÜN KODU
078 039 130002
ÜRÜN ADI
CAM ARMATÜR ÇİFT
DUYLU (BEYAZ)
AMBALAJ ADET / KOLİ
12
FİYAT
34,804 TL



ÜRÜN KODU
079 039 140002
ÜRÜN ADI
DEKORATİF CAM ARMATÜR
ÇİFT DUYLU (KROM)
AMBALAJ ADET / KOLİ
12
FİYAT
71,029 TL



ÜRÜN KODU
078 039 130001
ÜRÜN ADI
CAM ARMATÜR ÇİFT
DUYLU (KROM)
AMBALAJ ADET / KOLİ
12
FİYAT
42,618 TL

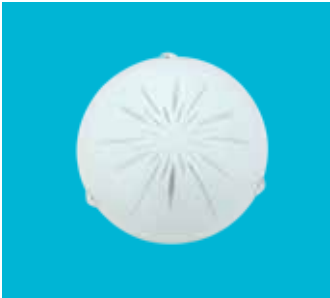

ÜRÜN KODU
079 039 140005
ÜRÜN ADI
CAM ARMATÜR
GÜNEŞ 30 Ø
AMBALAJ ADET / KOLİ
12
FİYAT
34,804 TL



ÜRÜN KODU
078 039 130130
ÜRÜN ADI
CAM ARMATÜR
MARTI 30 Ø
AMBALAJ ADET / KOLİ
12
FİYAT
34,804 TL

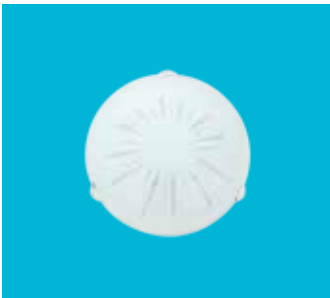

ÜRÜN KODU
079 039 140004
ÜRÜN ADI
CAM ARMATÜR
GÜNEŞ 25 Ø
AMBALAJ ADET / KOLİ
20
FİYAT
31,253 TL



ÜRÜN KODU
078 039 130125
ÜRÜN ADI
CAM ARMATÜR
MARTI 25 Ø
AMBALAJ ADET / KOLİ
12
FİYAT
31,253 TL

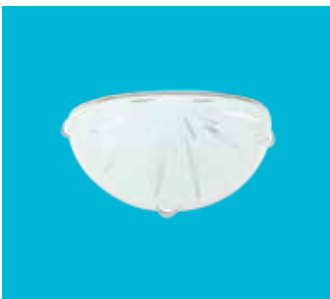

ÜRÜN KODU
079 039 140001
ÜRÜN ADI
YARIM AY CAM APLİK
GÜNEŞ
AMBALAJ ADET / KOLİ
20
FİYAT
30,543 TL



ÜRÜN KODU
078 039 130200
ÜRÜN ADI
YARIMAY CAM APLİK
MARTI
AMBALAJ ADET / KOLİ
20
FİYAT
30,543 TL



ARMATÜR ÇEŞİTLERİ



ÜRÜN KODU
001 038 250022 00 00
ÜRÜN ADI
360 DRC.SENSÖRLÜ TAVAN
ARAMTÜR (2X25 W)
AMBALAJ ADET / KOLİ
10
FİYAT
44,322 TL



ÜRÜN KODU
001 038 250025 00 00
ÜRÜN ADI
COMBO LEDLİ SENS.TAVAN
ARM. 2X25W (PİL DAHİL)
AMBALAJ ADET / KOLİ
10
FİYAT
112,226 TL



ÜRÜN KODU
001 038 250021 00 00
ÜRÜN ADI
360 DRC.SENSÖRLÜ TAVAN
ARMT.(2X25 W)(PİL DAHİL)
AMBALAJ ADET / KOLİ
10
FİYAT
92,026 TL



ÜRÜN KODU
016 038 250044
ÜRÜN ADI
SENSÖRLÜ 80 LEDLİ BEYAZ
ARMATÜR (PİL DAHİL)
AMBALAJ ADET / KOLİ
10
FİYAT
137,512 TL



ÜRÜN KODU
016 038 250061
ÜRÜN ADI
LEDLİ SENSÖRLÜ TAVAN
ARMATÜRÜ
AMBALAJ ADET / KOLİ
10
FİYAT
104,176 TL



ÜRÜN KODU
016 038 600080
ÜRÜN ADI
SENSÖRLÜ 80 LEDLİ KROM
ARMATÜR (PİL DAHİL)
AMBALAJ ADET / KOLİ
10
FİYAT
151,800 TL



ÜRÜN KODU
016 038 250060
ÜRÜN ADI
LEDLİ SENSÖRLÜ TAVAN
ARMATÜRÜ (PİL DAHİL)
AMBALAJ ADET / KOLİ
10
FİYAT
130,965 TL



ÜRÜN KODU
078 039 500100
ÜRÜN ADI
SENSÖRLÜ DUVAR APLİK
E-27 DUYLU
AMBALAJ ADET / KOLİ
20
FİYAT
52,088 TL



ÜRÜN KODU
016 038 250062
ÜRÜN ADI
LEDLİ CAMLI TAVAN
ARMATÜRÜ
AMBALAJ ADET / KOLİ
10
FİYAT
68,459 TL



ÜRÜN KODU
078 039 500110
ÜRÜN ADI
SENSÖRLÜ DUVAR APLİK
LEDLİ
AMBALAJ ADET / KOLİ
20
FİYAT
81,853 TL

ARMATÜR ÇEŞİTLERİ



ÜRÜN KODU
016 038 250031
ÜRÜN ADI
TAVAN GLOP ARMATÜRÜ
(MİNİ)
AMBALAJ ADET / KOLİ
48
FİYAT
5,398 TL



ÜRÜN KODU
001 038 120101 00 00
ÜRÜN ADI
ORKİDE TAVAN
ARMATÜRÜ
AMBALAJ ADET / KOLİ
48
FİYAT
9,259 TL



ÜRÜN KODU
001 038 050101 00 00
ÜRÜN ADI
YASEMİN UFO KÜRE TAVAN
ARMATÜRÜ
AMBALAJ ADET / KOLİ
12
FİYAT
14,425 TL



ÜRÜN KODU
001 038 160101 00 00
ÜRÜN ADI
YONCA TAVAN
ARMATÜRÜ
AMBALAJ ADET / KOLİ
16
FİYAT
9,197 TL



ÜRÜN KODU
001 038 070101 00 00
ÜRÜN ADI
YASEMİN UFO DÜZ TAVAN
ARMATÜRÜ
AMBALAJ ADET / KOLİ
12
FİYAT
14,132 TL



ÜRÜN KODU
001 038 060101 00 00
ÜRÜN ADI
YASEMİN KÜRE TAVAN
ARMATÜRÜ
AMBALAJ ADET / KOLİ
12
FİYAT
12,467 TL



ÜRÜN KODU
001 038 040101 00 00
ÜRÜN ADI
YASEMİN UFO TAVAN
ARMATÜRÜ
AMBALAJ ADET / KOLİ
12
FİYAT
15,317 TL



ÜRÜN KODU
001 038 030101 00 00
ÜRÜN ADI
YASEMİN DÜZ TAVAN
ARMATÜRÜ
AMBALAJ ADET / KOLİ
12
FİYAT
14,396 TL

Yeni



NEHİR SERİSİ ARMATÜR ÇEŞİTLERİ

Kod	Açıklama / Stok Cinsi	Kutu	Koli	FİYAT
024 038 340000	NEHİR SERİSİ AYDINLATMA ARMATÜRÜ (BEYAZ)	1	12	52,382
024 038 340011	NEHİR SERİSİ AYDINLATMA ARMATÜRÜ (SİYAH)	1	12	52,382
024 038 340031	NEHİR SERİSİ AYDINLATMA ARMATÜRÜ (FÜME)	1	12	52,382
024 038 340013	NEHİR SERİSİ AYDINLATMA ARMATÜRÜ (MAVİ)	1	12	52,382
024 038 340032	NEHİR SERİSİ AYDINLATMA ARMATÜRÜ (LİLA)	1	12	52,382
024 038 340033	NEHİR SERİSİ AYDINLATMA ARMATÜRÜ (BAL)	1	12	52,382
024 038 340015	NEHİR SERİSİ AYDINLATMA ARMATÜRÜ (YEŞİL)	1	12	52,382
024 038 340016	NEHİR SERİSİ AYDINLATMA ARMATÜRÜ (KIRMIZI)	1	12	52,382
024 038 341600	NEHİR SERİSİ AYDINLATMA ARMATÜRÜ (KIRMIZI+BEYAZ)	1	12	52,382
024 038 341100	NEHİR SERİSİ AYDINLATMA ARMATÜRÜ (SİYAH+BEYAZ)	1	12	52,382

KIZ ve ERKEK ÇOCUK ODASI ARMATÜRLERİ

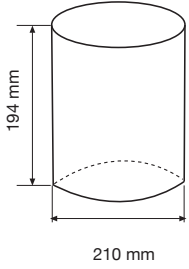

Duy : Porselen
Kablo : 2x0.75 TTR
Ürün Üst Gövdesi : Kristal
PVC Film
Class 1 : IP20



1

ÜRÜN KODU: 024 038 300001
ÜRÜN ADI : ERKEK ÇOCUK ODASI
ARMATÜRÜ MODEL 1
ADET/KOLİ : 1/12
FİYAT : 52,382 TL



2

ÜRÜN KODU: 024 038 300002
ÜRÜN ADI : ERKEK ÇOCUK ODASI
ARMATÜRÜ MODEL 2
ADET/KOLİ : 1/12
FİYAT : 52,382 TL



1

ÜRÜN KODU: 024 038 320001
ÜRÜN ADI : KIZ ÇOCUK ODASI
ARMATÜRÜ MODEL 1
ADET/KOLİ : 1/12
FİYAT : 52,382 TL

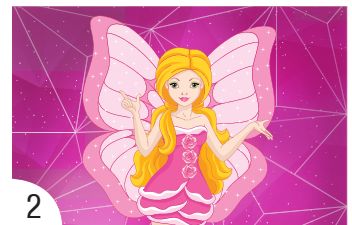

2

ÜRÜN KODU: 024 038 320002
ÜRÜN ADI : KIZ ÇOCUK ODASI
ARMATÜRÜ MODEL 2
ADET/KOLİ : 1/12
FİYAT : 52,382 TL



3

ÜRÜN KODU: 024 038 300003
ÜRÜN ADI : ERKEK ÇOCUK ODASI
ARMATÜRÜ MODEL 3
ADET/KOLİ : 1/12
FİYAT : 52,382 TL



4

ÜRÜN KODU: 024 038 300004
ÜRÜN ADI : ERKEK ÇOCUK ODASI
ARMATÜRÜ MODEL 4
ADET/KOLİ : 1/12
FİYAT : 52,382 TL

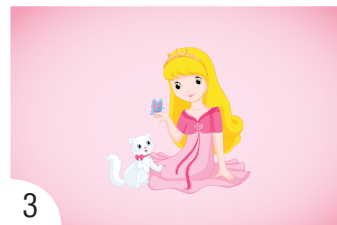

3

ÜRÜN KODU: 024 038 320003
ÜRÜN ADI : KIZ ÇOCUK ODASI
ARMATÜRÜ MODEL 3
ADET/KOLİ : 1/12
FİYAT : 52,382 TL



4

ÜRÜN KODU: 024 038 320004
ÜRÜN ADI : KIZ ÇOCUK ODASI
ARMATÜRÜ MODEL 4
ADET/KOLİ : 1/12
FİYAT : 52,382 TL



**BAHÇE
AYDINLATMA**



MUTLUSAN BAHÇE ARMATÜRLERİ



ÜRÜN KODU
016 038 010116
ÜRÜN ADI
FLORA BAHÇE ARMATÜRÜ
(SİYAH)
AMBALAJ ADET / KOLİ
1/12
FİYAT
28,276 TL



ÜRÜN KODU
016 038 020116
ÜRÜN ADI
FLORA BAHÇE ARMATÜRÜ
(BEYAZ)
AMBALAJ ADET / KOLİ
1/12
FİYAT
28,276 TL



ÜRÜN KODU
016 038 010117
ÜRÜN ADI
FLORA BAHÇE ARMATÜRÜ
APLİK (SİYAH)
AMBALAJ ADET / KOLİ
1/12
FİYAT
28,276 TL



ÜRÜN KODU
016 038 020117
ÜRÜN ADI
FLORA BAHÇE ARMATÜRÜ
APLİK (BEYAZ)
AMBALAJ ADET / KOLİ
1/12
FİYAT
28,276 TL



ÜRÜN KODU
016 038 412011
ÜRÜN ADI
FLORA BAHÇE ARMATÜRÜ
TAVAN TİPİ (SİYAH)
AMBALAJ ADET / KOLİ
1/12
FİYAT
28,276 TL



ÜRÜN KODU
016 038 412000
ÜRÜN ADI
FLORA BAHÇE ARMATÜRÜ
TAVAN TİPİ (BEYAZ)
AMBALAJ ADET / KOLİ
1/12
FİYAT
28,276 TL



ÜRÜN KODU
016 038 412111
ÜRÜN ADI
FLORA BAHÇE ARMATÜRÜ
YARIM APLİK (SİYAH)
AMBALAJ ADET / KOLİ
1/20
FİYAT
17,561 TL



ÜRÜN KODU
016 038 412100
ÜRÜN ADI
FLORA BAHÇE ARMATÜRÜ
YARIM APLİK (BEYAZ)
AMBALAJ ADET / KOLİ
1/20
FİYAT
17,561 TL



GÜÇ
7W
IP
67

DEKORATİF LED AMPUL

Kod		Fiyat
016 038 440001	SAPLAMALI BAHÇE AYDINLATMA ARMATÜRÜ (IP 67) 7W 220V (MAVİ)	163,706 \$
016 038 440002	SAPLAMALI BAHÇE AYDINLATMA ARMATÜRÜ (IP 67) 7W 220V (YEŞİL)	163,706 \$
016 038 440003	SAPLAMALI BAHÇE AYDINLATMA ARMATÜRÜ (IP 67) 7W 220V (KIRMIZI)	163,706 \$
016 038 440004	SAPLAMALI BAHÇE AYDINLATMA ARMATÜRÜ (IP 67) 7W 220V (SICAK BEYAZ)	163,706 \$
016 038 440005	SAPLAMALI BAHÇE AYDINLATMA ARMATÜRÜ (IP 67) 7W 220V (DOĞAL BEYAZ)	163,706 \$





Parklar, Bahçeler ve Kır Düğünlerinde **SU GEÇİRMEZ** Kurulumu Kolay Seyyar Aydınlatma Seti

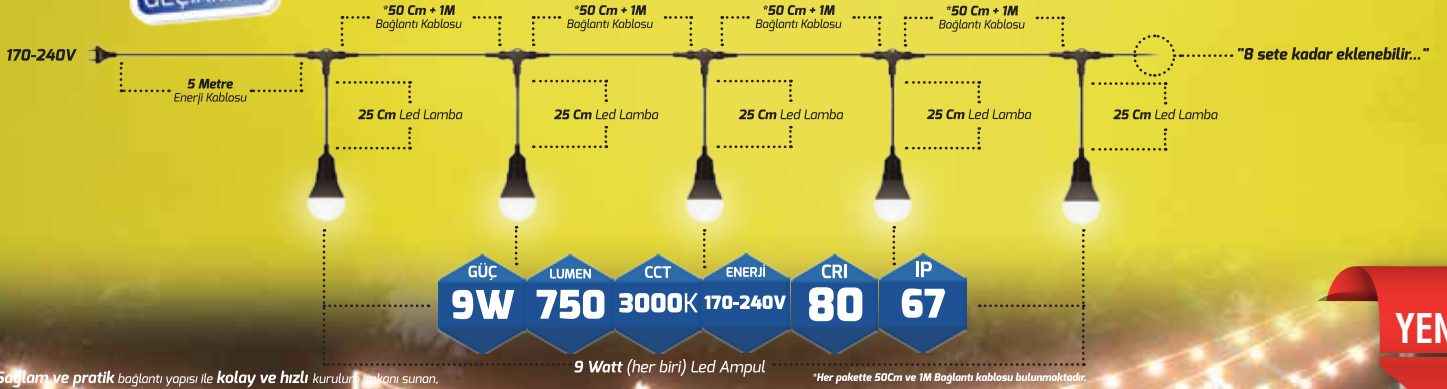

Sağlam ve pratik bağlantı yapısı ile **kolay ve hızlı** kurulumu mümkün sunan,
Olumsuz dış koşullara karşı son derece **dayanıklı**,
Özel tasarımı sayesinde **eklenebilir ve uzatılabilir** LED Lamba Seti.
Her türlü iç ve dış mekan aydınlatma uygulamaları için **ideal çözüm!**

9 Watt (her biri) Led Ampul

*Her pakette 50cm ve 1M Bağlantı Kablosu bulunmaktadır.

KOD	AÇIKLAMA	LUMEN	GÜÇ	IŞIK SICAKLIĞI	AMBALAJ	FİYAT
010 093 100900	9W 5'li Led Lamba Seti Dış Mekan (Su Geçirmez) (Park ve Bahçeler için Kurulumu Kolay Seyyar Aydınlatma Seti)	750 lm	9W	3000K	1 Takım	93,759 \$



010 093 100005 Power Kablo 5 MT 220V (Erkek Soketli) 6,757 \$



010 093 100001 T Bağlantı Adaptörü 2,976 \$

9W



010 093 100901 9W Led + Ara Kablo 25cm + Erkek Konnektör Takımı 750 lm 9W 3000K 12,320 \$



010 093 100000 1 Metre Ara Kablo İki Tarafı Konnektör Takılı 2,976 \$



010 093 100002 Sonlandırma Tapası 0,191 \$

DEKORATİF LED AMPUL

Kod	Fiyat
010 093 100101	8,929 \$
010 093 100102	8,929 \$
010 093 100103	8,929 \$
010 093 100104	8,929 \$
010 093 100105	8,929 \$
010 093 100106	8,929 \$
010 093 100107	8,929 \$



LACİVERT

BEYAZ

SARI

YEŞİL

KIRMIZI

ALTIN

BAKIR

SİYAH

RENKLİ DUY TAKIMI

Kod	Fiyat
010 093 100120	7,441 \$
010 093 100121	6,638 \$

IP68 SU GEÇİRMEZ SAHA MONTAJ KONNEKTÖR ve REKORLARI

Enerjinin kolay dağıtımına yardımcı olan, pratik ve hızlı montaj imkanı sunan, her türlü olumsuz doğa koşullarına son derece dayanıklı, darbelere karşı mukavemetli, **IP68** standartlarına uygun **Saha Montaj Konnektör Rekorları**.



TEKNİK ÖZELLİKLER

Kontakt Adedi : 3
 Min. Kablo Dış Çapı : 5,5mm
 Maks. Kablo Dış Çapı : 8,5mm
 Çalışma Sıcaklığı : -40°C ~ +105°C
 IP Sınıfı : IP68 (1m/30dak.)
 Gövde Materyali : PA6
 Terminal Materyali : Pirinç - Nikel Kaplama
 Conta Malzemesi : Silikon

SAHA MONTAJ I KONNEKTÖR

ÜRÜN KODU
010 093 130416

AMBALAJ ADET / KOLİ
1/10 ad.

FİYAT
5,358 \$



TEKNİK ÖZELLİKLER

Kontakt Adedi : 3
 Min. Kablo Dış Çapı : 5,5mm
 Maks. Kablo Dış Çapı : 8,5mm
 Çalışma Sıcaklığı : -40°C ~ +105°C
 IP Sınıfı : IP68 (1m/30dak.)
 Gövde Materyali : PA6
 Terminal Materyali : Pirinç - Nikel Kaplama
 Conta Malzemesi : Silikon

SAHA MONTAJ T KONNEKTÖR

ÜRÜN KODU
010 093 130315

AMBALAJ ADET / KOLİ
1/5 ad.

FİYAT
8,929 \$



TEKNİK ÖZELLİKLER



Kontakt Adedi : 3
 Min. Kablo Dış Çapı : 5,5mm
 Maks. Kablo Dış Çapı : 8,5mm
 Çalışma Sıcaklığı : -40°C ~ +105°C
 IP Sınıfı : IP68 (1m/30dak.)
 Gövde Materyali : PA6
 Terminal Materyali : Pirinç - Nikel Kaplama
 Conta Malzemesi : Silikon

SAHA MONTAJ PANEL KONNEKTÖR

ÜRÜN KODU
010 093 130200

AMBALAJ ADET / KOLİ
1/10 ad.

FİYAT
5,358 \$

TEKNİK ÖZELLİKLER

Kontakt Adedi : 3
 Min. Kablo Dış Çapı : 5,5mm
 Maks. Kablo Dış Çapı : 8,5mm
 Çalışma Sıcaklığı : -40°C ~ +85°C
 IP Sınıfı : IP68 (60 min. 50m.)
 Gövde Materyali : PA6
 Terminal Materyali : Pirinç - Nikel Kaplama

SAHA MONTAJ DÜZ KONNEKTÖR

ÜRÜN KODU
010 093 130215

AMBALAJ ADET / KOLİ
1/10 ad.

FİYAT
5,358 \$



Teknik Özellikler

Kontakt Adedi : 3
 Min. Kablo Dış Çapı : 5,5mm
 Maks. Kablo Dış Çapı : 8,5mm
 Çalışma Sıcaklığı : -40°C + 105°C
 IP Sınıfı : IP68 (1m/30dak.)
 Gövde Materyali : PA6
 Terminal Materyali : Pirinç - Nikel Kaplama
 Conta Malzemesi : Silikon

1x3
Enerji Dağıtıcı

ÜRÜN KODU
010 093 130420

AMBALAJ ADET / KOLİ
1/10 ad.

FİYAT
23,812 \$



Teknik Özellikler

Kontakt Adedi : 3
 Min. Kablo Dış Çapı : 5,5mm
 Maks. Kablo Dış Çapı : 8,5mm
 Çalışma Sıcaklığı : -40°C + 105°C
 IP Sınıfı : IP68 (1m/30dak.)
 Gövde Materyali : PA6
 Terminal Materyali : Pirinç - Nikel Kaplama
 Conta Malzemesi : Silikon

1x5
Enerji Dağıtıcı

ÜRÜN KODU
010 093 130617

AMBALAJ ADET / KOLİ
1/5 ad.

FİYAT
35,718 \$

LED

ACİL
AYDINLATMA
ARMATÜRLERİ



EXIT - ŞEFFAF ACİL AYDINLATMA ARMATÜRLERİ (LEDLİ) IP20

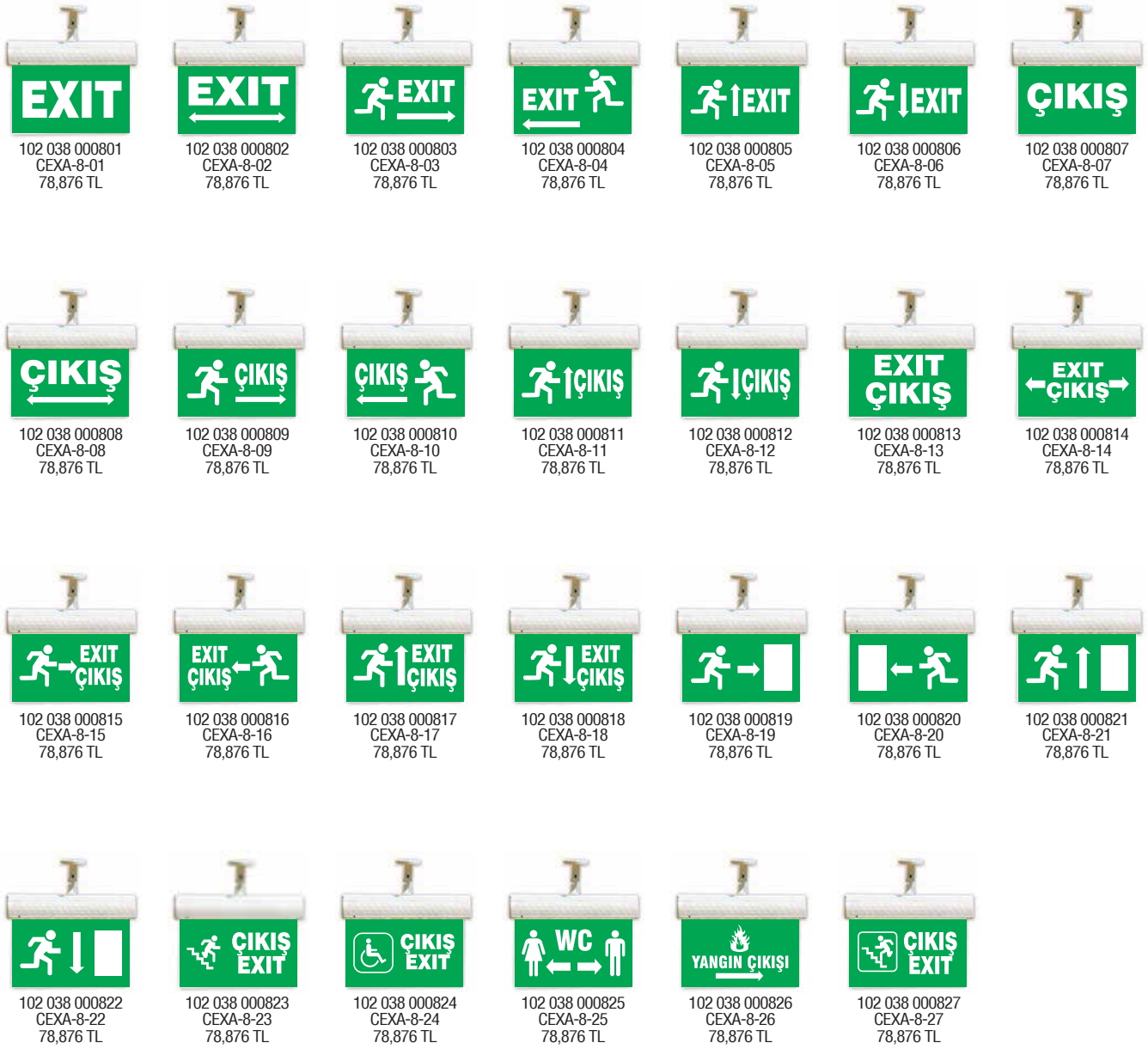

FOSFORLU SERİ ACİL AYDINLATMA ARMATÜRÜ

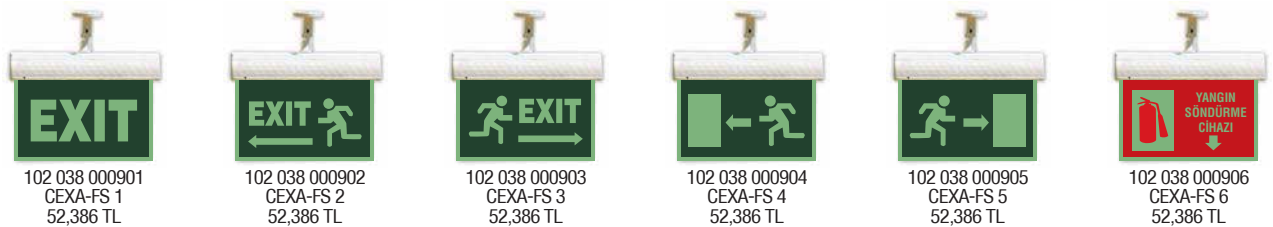

ÇİFT YÜZLÜ YÖN TAVAN SERİSİ LEDLİ ACİL DURUM ARMATÜRLERİ IP20

ÇİFT YÜZLÜ YÖN TAVAN SERİSİ LEDLİ ACİL DURUM ARMATÜRLERİ



Dekoratif ABS gövde
Acilde veya sürekli çalışma
1 veya 3 saat yanma süresi
NI- CD Uzun ömürlü batarya
Pleksiglas üzeri gravür veya UV uygulama
Adetli alımlarda farklı renk seçenekleri
Ultra parlak ledler
Aşırı şarj ve deşarja karşı koruma
Şarj olma süresi 24 saat

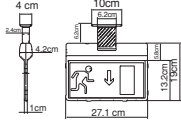

112 038 1000-XX
87,736 TL

ÇİFT YÜZLÜ YÖN DUVAR SERİSİ LEDLİ ACİL DURUM ARMATÜRLERİ



Dekoratif ABS gövde
Acilde veya sürekli çalışma
1 veya 3 saat yanma süresi
NI- CD Uzun ömürlü batarya
Pleksiglas üzeri gravür veya UV uygulama
Adetli alımlarda farklı renk seçenekleri
Ultra parlak ledler
Aşırı şarj ve deşarja karşı koruma
Şarj olma süresi 24 saat

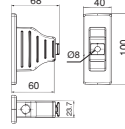

112 038 2000-XX
93,418 TL

BİLGİ SERİSİ LEDLİ ACİL DURUM ARMATÜRLERİ



Acilde 1 veya 3 saat seçeneği
NI-CD Uzun ömürlü batarya
Sürekli veya acilde yanma imkanı
340x90x48 mm ölçülerinde
Akrilik üzeri folyo veya UV boyama
Şarj olma süresi 24 Saat



112 038 4000-XX
80,831 TL

ÇİFT YÜZLÜ SIVA ALTI SERİSİ LEDLİ ACİL DURUM ARMATÜRLERİ



Kombine bir modeldir,
Hem aydınlatma hem de yönlendirmeyi sağlar.
Dekoratif ABS gövde
Acilde veya sürekli çalışma
1 veya 3 saat yanma süresi
NI-CD Uzun ömürlü batarya
Pleksiglas üzeri gravür uygulama
Tavana siva altı uygulama
Ultra parlak ledler
Aşırı şarj ve deşarja karşı koruma
Şarj olma süresi 24 saat



112 038 6000-XX
187,101 TL

ÇİFT YÜZLÜ SIVA ÜSTÜ SERİSİ LEDLİ ACİL DURUM ARMATÜRLERİ





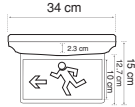









Kombine bir modeldir,
Hem aydınlatma hem de yönlendirmeyi sağlar.
Dekoratif ABS gövde
Acilde veya sürekli çalışma
1 veya 3 saat yanma süresi
NI-CD Uzun ömürlü batarya
Pleksiglas üzeri gravür uygulama
Tavana siva üstü uygulama
Ultra parlak ledler
Aşırı şarj ve deşarja karşı koruma
Şarj olma süresi 24 saat



112 038 5000-XX
180,285 TL

SEMBOLE KOD TABLOSU

01	ÇIKIŞ	02	EXIT	03	
04		05		06	
07		08		09	
10		11		12	
13		14		15	
16	خروج	17	ÇIKIŞ EXIT	18	ACİL ÇIKIŞ

Standart sembol seçenekleri dışında istenilen sembol uygulanabilir.

*Yazı Karakteri Olan Ürünler Tek Yüzlüdür.

*Sipariş Verdiğiniz Ürünün Sembol Kodunu Yazmayı Unutmayınız.

*Ürün Kodunun Son 2 hanesi olan XX Rakamları Ürünün Sembol Kodunu belirtmektedir.

LEDLİ ACİL AYDINLATMA ARMATÜRLERİ



17,34,51 led seçenekleri ile
Acilde veya sürekli çalışma
1 veya 3 saat yanma süresi
NI-CD Uzun ömürlü batarya
Dekoratif ABS gövde
Tavana siva altı uygulama
Ultra parlak ledler
Aşırı şarj ve deşarja karşı koruma
Şarj olma süresi 24 saat
Besleme / Şarj / Hata gösterge ledleri
Dahili test butonu
Düşük bakım maliyeti

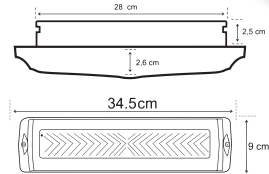
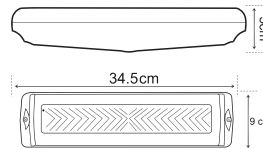

Turkey
Discover the potential

YENİ

Ürün Kodu	Açıklama / Stok Cinsi	Ambalaj (Kutulu)	TL
112 039 011717	17 Ledli S/Ü Acil Aydınlatma Armatürü	1 ad.	134,328
112 039 013434	34 Ledli S/Ü Acil Aydınlatma Armatürü	1 ad.	144,746
112 039 015151	51 Ledli S/Ü Acil Aydınlatma Armatürü	1 ad.	159,628
112 039 121717	17 Ledli S/A Acil Aydınlatma Armatürü	1 ad.	143,258
112 039 123434	34 Ledli S/A Acil Aydınlatma Armatürü	1 ad.	153,675
112 039 125151	51 Ledli S/A Acil Aydınlatma Armatürü	1 ad.	168,558

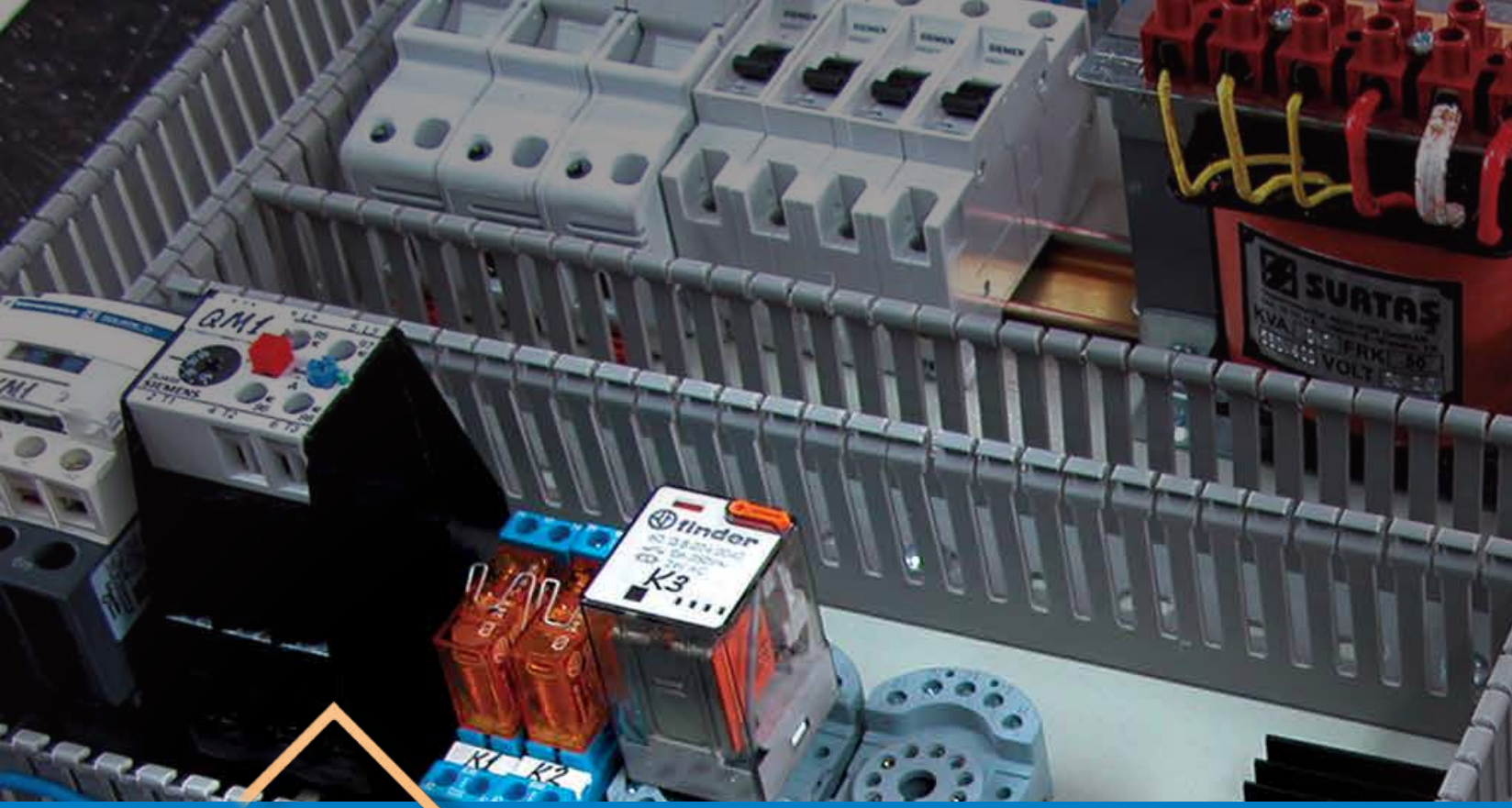

OTOMASYON ve PANO ÜRÜNLER

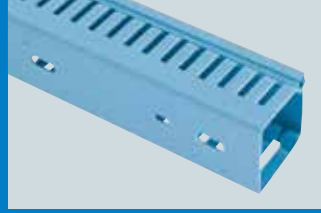

DÜZENLİ ARALIKLARLA MONTAJ DELİKLERİ
ASSEMBLY HOLES WITH REGULAR INTERVALS

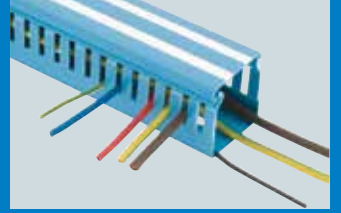

YAZI YAZMAYI KOLAYLAŞTIRAN BEYAZ BANTLAR
EASY TO WRITE WHITE STRIPS

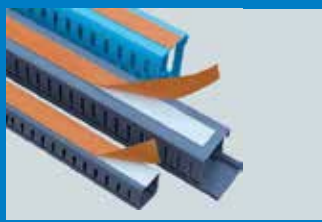

**KOLAY YAPISMAYI SAĞLAYAN,
ÇİFT TARAFLI BANT KULLANILABİLİR**
DOUBLE SIDED ADHESIVE TAPE ASSURING
EASY FIXATION CAN BE USED

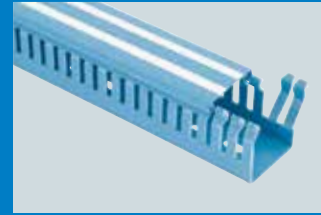

KOLAY KIRILABİLEN KANAL ÇUBUKLARI
EASILY BREAKABLE TRUNKING SLOTS

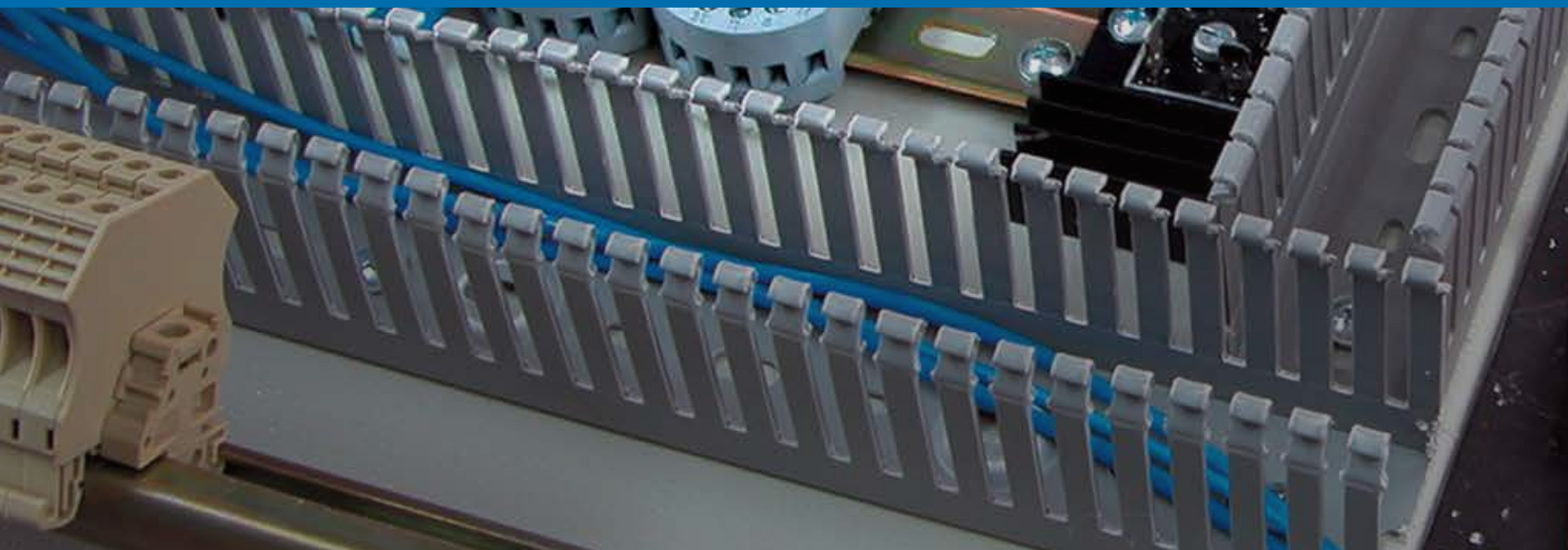
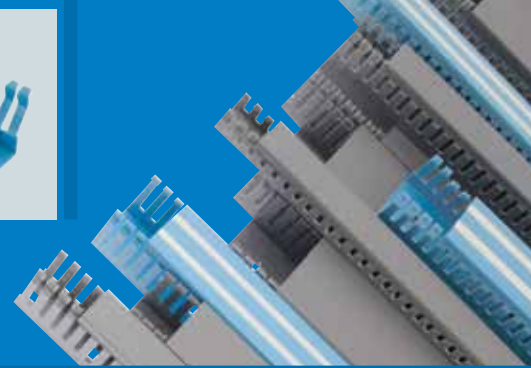

Kod	Açıklama / Stok Cinsi	Amb. (Kutu/Bağ)	Amb. (Kali/Çvl.)	FİYAT
PANO İÇİN SÜPER LÜX KANALLAR (GRİ) HALOGEN FREE (ALEV YAYMAYAN)				
001 065 025025 20 17	25X25 KABLO KAN. HALOGEN FREE (ALEV YAYMAYAN)(DELİKLİ)(GRİ)	1mt. 64	2mt. 128	10,919
001 065 025040 20 17	25X40 KABLO KAN. HALOGEN FREE (ALEV YAYMAYAN)(DELİKLİ)(GRİ)	1mt. 40	2mt. 80	14,359
001 065 040040 20 17	40X40 KABLO KAN. HALOGEN FREE (ALEV YAYMAYAN)(DELİKLİ)(GRİ)	1mt. 25	2mt. 50	19,559
001 065 040060 20 17	40X60 KABLO KAN. HALOGEN FREE (ALEV YAYMAYAN)(DELİKLİ)(GRİ)	1mt. 24	2mt. 48	22,900
PANO İÇİN SÜPER LÜX KANALLAR (GRİ)				
001 005 025025 20 17	25X25 KABLO KAN.(DELİKLİ)(GRİ)	1mt. 64	2mt. 128	3,001
001 005 025040 20 17	25X40 KABLO KAN.(DELİKLİ)(GRİ)	1mt. 40	2mt. 80	4,052
001 005 025060 20 17	25X60 KABLO KAN.(DELİKLİ)(GRİ)	1mt. 36	2mt. 80	6,983
001 005 040040 20 17	40X40 KABLO KAN.(DELİKLİ)(GRİ)	1mt. 25	2mt. 50	5,199
001 005 040060 20 17	40X60 KABLO KAN.(DELİKLİ)(GRİ)	1mt. 24	2mt. 48	6,540
001 005 060040 20 17	60X40 KABLO KAN.(DELİKLİ)(GRİ)	1mt. 24	2mt. 48	6,778
001 005 060060 20 17	60X60 KABLO KAN.(DELİKLİ)(GRİ)	1mt. 16	2mt. 32	8,801
001 005 060080 20 17	60X80 KABLO KAN.(DELİKLİ)(GRİ)	1mt. 12	2mt. 24	13,186
001 005 060100 20 17	60X100 KABLO KAN.(DELİKLİ)(GRİ)	1mt. 8	2mt. 16	15,610
001 005 040080 20 17	40X80 KABLO KAN.(DELİKLİ)(GRİ)	1mt. 18	2mt. 36	10,898
001 005 080060 20 17	80X60 KABLO KAN.(DELİKLİ)(GRİ)	1mt. 12	2mt. 24	13,186
001 005 100060 20 17	100X60 KABLO KAN.(DELİKLİ)(GRİ)	1mt. 8	2mt. 16	15,610
001 005 100100 20 17	100X100 KABLO KAN.(DELİKLİ)(GRİ)	1mt. 4	2mt. 8	21,821
PANO İÇİN SÜPER LÜX KANALLAR (MAVİ-BEYAZ-ŞERİT)				
001 005 025025 20 13	25X25 KABLO KAN.(DELİKLİ)(MAVİ)	1mt. 64	2mt. 128	3,133
001 005 025040 20 13	25X40 KABLO KAN.(DELİKLİ)(MAVİ)	1mt. 40	2mt. 80	4,231
001 005 025060 20 13	25X60 KABLO KAN.(DELİKLİ)(MAVİ)	1mt. 36	2mt. 80	7,290
001 005 040040 20 13	40X40 KABLO KAN.(DELİKLİ)(MAVİ)	1mt. 25	2mt. 50	5,427
001 005 040060 20 13	40X60 KABLO KAN.(DELİKLİ)(MAVİ)	1mt. 24	2mt. 48	6,828
001 005 060040 20 13	60X40 KABLO KAN.(DELİKLİ)(MAVİ)	1mt. 24	2mt. 48	7,077
001 005 060060 20 13	60X60 KABLO KAN.(DELİKLİ)(MAVİ)	1mt. 16	2mt. 32	9,188
001 005 060080 20 13	60X80 KABLO KAN.(DELİKLİ)(MAVİ)	1mt. 12	2mt. 24	13,765
001 005 060100 20 13	60X100 KABLO KAN.(DELİKLİ)(MAVİ)	1mt. 8	2mt. 16	16,296
001 005 040080 20 13	40X80 KABLO KAN.(DELİKLİ)(MAVİ)	1mt. 18	2mt. 36	11,377
001 005 080060 20 13	80X60 KABLO KAN.(DELİKLİ)(MAVİ)	1mt. 12	2mt. 24	13,765
001 005 100060 20 13	100X60 KABLO KAN.(DELİKLİ)(MAVİ)	1mt. 8	2mt. 16	16,296
001 005 100100 20 13	100X100 KABLO KAN.(DELİKLİ)(MAVİ)	1mt. 4	2mt. 8	22,744
YAPIŞKAN BANTLI DELİKLİ KANALLAR (MAVİ-BEYAZ-ŞERİT)				
001 008 025025 20 13	25X25 MM DEL.KANAL YPŞK.BANTLI (MAVİ)	1mt. 64	2mt. 128	3,588
001 008 025040 20 13	25X40 MM DEL.KANAL YPŞK.BANTLI (MAVİ)	1mt. 40	2mt. 80	4,686
001 008 025060 20 13	25X60 MM DEL.KANAL YPŞK.BANTLI (MAVİ)	1mt. 36	2mt. 80	7,745
001 008 040040 20 13	40X40 MM DEL.KANAL YPŞK.BANTLI (MAVİ)	1mt. 25	2mt. 50	6,423
001 008 040060 20 13	40X60 MM DEL.KANAL YPŞK.BANTLI (MAVİ)	1mt. 24	2mt. 48	7,824
001 008 060040 20 13	60X40 MM DEL.KANAL YPŞK.BANTLI (MAVİ)	1mt. 24	2mt. 48	8,641
001 008 060060 20 13	60X60 MM DEL.KANAL YPŞK.BANTLI (MAVİ)	1mt. 16	2mt. 32	11,421
001 008 060080 20 13	60X80 MM DEL.KANAL YPŞK.BANTLI (MAVİ)	1mt. 12	2mt. 24	15,330
001 008 060100 20 13	60X100 MM DEL.KANAL YPŞK.BANTLI (MAVİ)	1mt. 8	2mt. 16	17,860
001 008 040080 20 13	40X80 MM DEL.KANAL YPŞK.BANTLI (MAVİ)	1mt. 18	2mt. 36	12,198
001 008 080060 20 13	80X60 MM DEL.KANAL YPŞK.BANTLI (MAVİ)	1mt. 12	2mt. 24	15,330
001 008 100060 20 13	100X60 MM DEL.KANAL YPŞK.BANTLI (MAVİ)	1mt. 8	2mt. 16	17,860
001 008 100100 20 13	100X100 MM DEL.KANAL YPŞK.BANTLI (MAVİ)	1mt. 4	2mt. 8	23,036
YAPIŞKAN BANTLI DELİKLİ KANALLAR (GRİ)				
001 008 025025 20 17	25X25 MM DEL.KANAL YPŞK.BANTLI (GRİ)	1mt. 64	2mt. 128	3,586
001 008 025040 20 17	25X40 MM DEL.KANAL YPŞK.BANTLI (GRİ)	1mt. 40	2mt. 80	4,684
001 008 025060 20 17	25X60 MM DEL.KANAL YPŞK.BANTLI (GRİ)	1mt. 36	2mt. 80	7,741
001 008 040040 20 17	40X40 MM DEL.KANAL YPŞK.BANTLI (GRİ)	1mt. 25	2mt. 50	6,420
001 008 040060 20 17	40X60 MM DEL.KANAL YPŞK.BANTLI (GRİ)	1mt. 24	2mt. 48	7,820
001 008 060040 20 17	60X40 MM DEL.KANAL YPŞK.BANTLI (GRİ)	1mt. 24	2mt. 48	8,637
001 008 060060 20 17	60X60 MM DEL.KANAL YPŞK.BANTLI (GRİ)	1mt. 16	2mt. 32	11,417
001 008 060080 20 17	60X80 MM DEL.KANAL YPŞK.BANTLI (GRİ)	1mt. 12	2mt. 24	15,324
001 008 060100 20 17	60X100 MM DEL.KANAL YPŞK.BANTLI (GRİ)	1mt. 8	2mt. 16	17,853
001 008 040080 20 17	40X80 MM DEL.KANAL YPŞK.BANTLI (GRİ)	1mt. 18	2mt. 36	12,193
001 008 080060 20 17	80X60 MM DEL.KANAL YPŞK.BANTLI (GRİ)	1mt. 12	2mt. 24	15,324
001 008 100060 20 17	100X60 MM DEL.KANAL YPŞK.BANTLI (GRİ)	1mt. 8	2mt. 16	17,853
001 008 100100 20 17	100X100 MM DEL.KANAL YPŞK.BANTLI (GRİ)	1mt. 4	2mt. 8	23,025
HAREKETLİ KABLO KANALLARI				
888 140 001515	15x15 MM HAREKETLİ KABLO KANALI		1 mt.	26,450€
888 140 001825	18x25 MM HAREKETLİ KABLO KANALI		1 mt.	26,450€
888 140 002025	20x25 MM HAREKETLİ KABLO KANALI		1 mt.	35,785€
888 140 002040	20x40 MM HAREKETLİ KABLO KANALI		1 mt.	37,341€
888 140 002050	20x50 MM HAREKETLİ KABLO KANALI		1 mt.	40,453€
888 140 002540	25x40 MM HAREKETLİ KABLO KANALI		1 mt.	40,453€
888 140 003040	30x40 MM HAREKETLİ KABLO KANALI		1 mt.	46,676€
888 140 003041	MONTAJ AYAKLARI (1 TAKIM)		1 mt.	6,224€

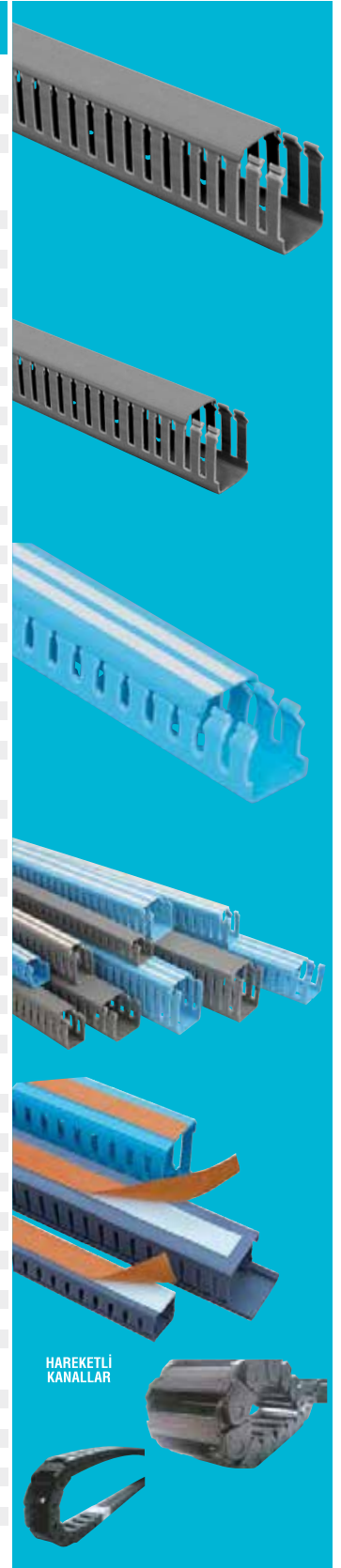

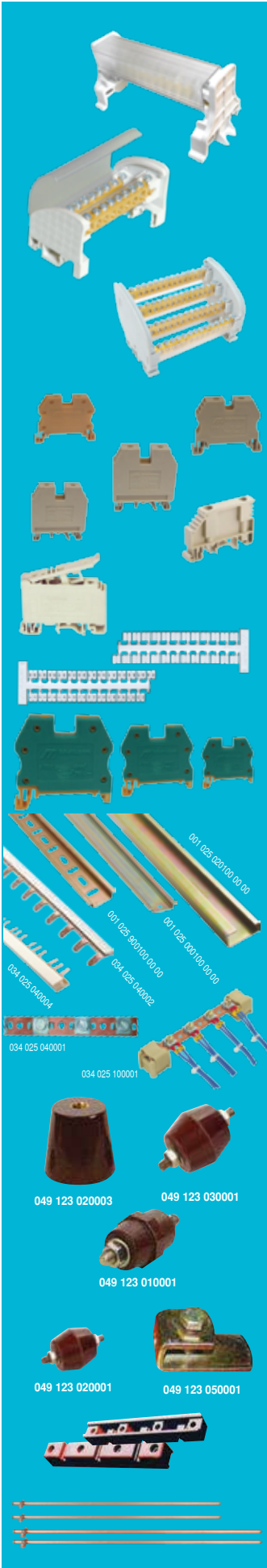

Kod	Açıklama / Stok Cinsi	Amb. (Kutu/Bağ)	Amb. (Koli/Çv)	FİYAT
125 A. 1 KUTUPLU DAĞITIM ÜNİTESİ (7X12 MM)				
014 102 112507	125 A. 1 KUTUP DAĞITIM ÜNİTESİ 7 DELİKLİ		65	9,376
014 102 112510	125 A. 1 KUTUP DAĞITIM ÜNİTESİ 10 DELİKLİ		48	11,162
014 102 112512	125 A. 1 KUTUP DAĞITIM ÜNİTESİ 12 DELİKLİ		40	13,096
014 102 112515	125 A. 1 KUTUP DAĞITIM ÜNİTESİ 15 DELİKLİ		36	14,882
014 102 112520	125 A. 1 KUTUP DAĞITIM ÜNİTESİ 20 DELİKLİ		30	20,835
125 A. 2 KUTUPLU DAĞITIM ÜNİTESİ (7X12 MM)				
014 102 212507	125 A. 2 KUTUP DAĞITIM ÜNİTESİ 7 DELİKLİ		22	19,347
014 102 212510	125 A. 2 KUTUP DAĞITIM ÜNİTESİ 10 DELİKLİ		15	21,579
014 102 212512	125 A. 2 KUTUP DAĞITIM ÜNİTESİ 12 DELİKLİ		14	23,812
014 102 212515	125 A. 2 KUTUP DAĞITIM ÜNİTESİ 15 DELİKLİ		12	31,253
014 102 212520	125 A. 2 KUTUP DAĞITIM ÜNİTESİ 20 DELİKLİ		6	40,182
125 A. 4 KUTUPLU DAĞITIM ÜNİTESİ (7X12 MM)				
014 102 412507	125 A. 4 KUTUP DAĞITIM ÜNİTESİ 7 DELİKLİ		10	38,694
014 102 412510	125 A. 4 KUTUP DAĞITIM ÜNİTESİ 10 DELİKLİ		8	40,926
014 102 412512	125 A. 4 KUTUP DAĞITIM ÜNİTESİ 12 DELİKLİ		6	46,879
014 102 412515	125 A. 4 KUTUP DAĞITIM ÜNİTESİ 15 DELİKLİ		5	57,297
014 102 412520	125 A. 4 KUTUP DAĞITIM ÜNİTESİ 20 DELİKLİ		4	75,156
014 102 412522	125 A. 4 KUTUP DAĞITIM ÜNİTESİ 22 DELİKLİ		4	80,365
014 102 412525	125 A. 4 KUTUP DAĞITIM ÜNİTESİ 25 DELİKLİ		4	93,759
RAY KLEMENSLER (VİDALI)				
010 094 000025	2,5 MM RAY KLEMENSİ	100 ad.		1,786
010 094 000004	4 MM RAY KLEMENSİ	100 ad.		1,994
010 094 000006	6 MM RAY KLEMENSİ	100 ad.		2,976
010 094 000010	10 MM RAY KLEMENSİ	100 ad.		4,465
010 094 000016	16 MM RAY KLEMENSİ	30 ad.		6,846
010 094 000035	35 MM RAY KLEMENSİ	30 ad.		11,906
010 094 010001	KLEMENS DURDURUCU	20 ad.		1,786
SİĞORTALI RAY KLEMENSLER				
010 094 000051	SİĞORTALI RAY KLEMENS	75 ad.		8,929
DEKAFİX				
010 094 010006	YAZILI DEKAFİX (1 ADET FİYATI)	500 ad.		0,089
010 094 010007	YAZISIZ DEKAFİX (1 ADET FİYATI)	500 ad.		0,071
RAY KLEMENSLER (TOPRAKLAMALI)				
010 094 010003	2,5 MM TOPRAKLAMALI RAY KLEMENSİ	100 ad.		7,144
010 094 010008	4 MM TOPRAKLAMALI RAY KLEMENSİ	100 ad.		7,144
010 094 010004	6 MM TOPRAKLAMALI RAY KLEMENSİ	100 ad.		8,929
010 094 010009	10 MM TOPRAKLAMALI RAY KLEMENSİ	100 ad.		8,929
010 094 010005	16 MM TOPRAKLAMALI RAY KLEMENSİ	30 ad.		16,966
010 094 010010	35 MM TOPRAKLAMALI RAY KLEMENSİ	20 ad.		19,049
RAYLAR-TOPRAKLAMA ÇUBUKLARI VE BARALAR				
014 094 020001	RAY TAŞIYICISI (SAC)	150 ad.		1,548
001 025 020100 00 00	KLEMENS RAY(1M)	25 mt.		10,181
001 025 000100 00 00	W OTOMAT RAY(1M)	50 mt.		5,364
001 025 000033 00 00	W OTOMAT RAY(33CM)	50 ad.		1,767
001 025 000099 99 00	W OTOMAT RAY(ÖZEL BOY)	50 ad.		5,392
001 025 900100 00 00	W OTOMAT RAY(DELİKLİ)(1M)	50 mt.		5,454
034 025 100001	TOPRAKLAMA BARASI MİSNEDİ	50 ad.		1,072
034 025 040001	TOPRAKLAMA BARASI 1 M.	25 ad.		29,169
034 025 040004	TRİF. MÜŞTEREK BARA İĞNE UÇLU 53 CM	24 ad.		31,253
034 025 040006	TRİF.MÜŞTEREK BARA İĞNE UÇLU 106 CM	24 ad.		62,506
034 025 040002	MON.MÜŞTEREK BARA İĞNE UÇLU 106 CM	50 ad.		22,324
MINİ BOY MESNET İZOLATÖRLERİ A.G. (1KV)				
049 123 010001	BMI-M 5/2C MINİ İZOLATÖR	300 ad.		1,136
049 123 010002	BMI-M 5/1C+1S MINİ İZOLATÖR	300 ad.		1,421
049 123 010003	BMI-M 5/2S MINİ İZOLATÖR	300 ad.		1,875
ORTA BOY KONİK MESNET İZOLATÖRLERİ A.G. (1KV)				
049 123 020001	BMI-M 6/2C ORTA KONİK İZOLATÖR	100 ad.		1,989
049 123 020002	BMI-M 6/1C+1S ORTA KONİK İZOLATÖR	100 ad.		2,273
049 123 020003	BMI-M 6/2S ORTA KONİK İZOLATÖR	100 ad.		2,557
BÜYÜK BOY MESNET İZOLATÖRLERİ A.G. (1KV)				
049 123 030001	BMI-M 8/2C BÜYÜK BOY KONİK İZOLATÖR	40 ad.		3,551
049 123 030002	BMI-M 8/1C+1S BÜYÜK BOY KONİK İZOLATÖR	40 ad.		4,205
049 123 030003	BMI-M 8/2S BÜYÜK BOY KONİK İZOLATÖR	40 ad.		4,546
049 123 030004	BMI-M 10/2C BÜYÜK BOY KONİK İZOLATÖR	40 ad.		4,972
049 123 030005	BMI-M 10/1C+1S BÜYÜK BOY KONİK İZOLATÖR	40 ad.		5,114
049 123 030006	BMI-M 10/2S BÜYÜK BOY KONİK İZOLATÖR	40 ad.		5,199
049 123 050001	BMS (M8-M10) BARA TUTUCU	50 ad.		3,492
TARAK İZOLATÖRLER				
049 123 040001	3X1 F TARAK İZOLATÖR (2ADET TAKIM)	20 tkm.		15,626
049 123 040002	3X2 F TARAK İZOLATÖR (2ADET TAKIM)	20 tkm.		18,468
049 123 040003	3X1 F+N TARAK İZOLATÖR (2ADET TAKIM)	20 tkm.		19,206
049 123 040005	3X2 F+N TARAK İZOLATÖR (2ADET TAKIM)	4 tkm.		24,434
BORU GEÇME TOPRAKLAMA ÇUBUĞU				
091 025 011610	TOP ÇUBUĞU BORU GEÇMELİ 16 MM 1 MT	10 ad.		66,057
091 025 011615	TOP ÇUBUĞU BORU GEÇMELİ 16 MM 1,5 MT	10 ad.		98,021
091 025 012010	TOP ÇUBUĞU BORU GEÇMELİ 20 MM 1 MT	5 ad.		92,338
091 025 012015	TOP ÇUBUĞU BORU GEÇMELİ 20 MM 1,5 MT	5 ad.		138,507

Kod	Açıklama / Stok Cinsi	Amb. (Kutu/Bağ)	Amb. (Koli/Çvl.)	FİYAT
CABLE FIX KABLO BAĞLARI				
CE				
062 129 925100	KABLO BAĞI 2.5X100	100 ad.	40000	0,019
062 129 925150	KABLO BAĞI 2.5X150	100 ad.	20000	0,031
062 129 925200	KABLO BAĞI 2.5X200	100 ad.	15000	0,043
062 129 936150	KABLO BAĞI 3.6X150	100 ad.	10000	0,046
062 129 936200	KABLO BAĞI 3.6X200	100 ad.	10000	0,058
062 129 936250	KABLO BAĞI 3.6X250	100 ad.	10000	0,073
062 129 936300	KABLO BAĞI 3.6X300	100 ad.	10000	0,088
062 129 936370	KABLO BAĞI 3.6X370	100 ad.	10000	0,108
062 129 948200	KABLO BAĞI 4.8X200	100 ad.	10000	0,081
062 129 948250	KABLO BAĞI 4.8X250	100 ad.	10000	0,099
062 129 948300	KABLO BAĞI 4.8X300	100 ad.	10000	0,114
062 129 948380	KABLO BAĞI 4.8X380	100 ad.	5000	0,156
062 129 948400	KABLO BAĞI 4.8X400	100 ad.	5000	0,158
062 129 976300	KABLO BAĞI 7.6X300	100 ad.	3000	0,221
062 129 976380	KABLO BAĞI 7.6X380	100 ad.	2500	0,272
062 129 972450	KABLO BAĞI 7.2X450	100 ad.	3000	0,316
062 129 976550	KABLO BAĞI 7.6X550	100 ad.	2500	0,426
062 129 990750	KABLO BAĞI 9X750	100 ad.	1000	0,684
062 129 990900	KABLO BAĞI 9X900	100 ad.	1000	1,034
060 129 101919	YAPIŞKANLI KROŞE 19x19	100 ad.	10000	0,150
060 129 102828	YAPIŞKANLI KROŞE 28X28	100 ad.	4000	0,175

PEMSAN YERLİ KABLO BAĞLARI (SİYAH-BEYAZ)

062 129 010101	EA.01.101 BONCUK KELEPÇE 2X105	1000 ad.		0,041
062 129 010102	EA.02.102 BONCUK KELEPÇE 3.5X165	500 ad.		0,083
062 129 025100	EB.02.202 KABLO BAĞI 2.5X100	1000 ad.	50000	0,020
062 129 025140	EB.12.212 KABLO BAĞI 2.5X140	100 ad.	35000	0,032
062 129 025200	EB.13.213 KABLO BAĞI 2.5X200	100 ad.	30000	0,047
062 129 036150	EB.03.203 KABLO BAĞI 3.6X150	100 ad.	25000	0,048
062 129 036205	EB.04.204 KABLO BAĞI 3.6X205	100 ad.	20000	0,065
062 129 036250	EB.09.209 KABLO BAĞI 3.6X250	100 ad.	15000	0,084
062 129 036300	EB.10.210 KABLO BAĞI 3.6X300	100 ad.	15000	0,104
062 129 036370	EB.11.211 KABLO BAĞI 3.6X370	100 ad.	10000	0,128
062 129 048200	EB.14.214 KABLO BAĞI 4.8X200	100 ad.	15000	0,093
062 129 048250	EB.06.206 KABLO BAĞI 4.8X250	100 ad.	10000	0,116
062 129 048300	EB.05.205 KABLO BAĞI 4.8X300	100 ad.	10000	0,135
062 129 048400	EB.16.216 KABLO BAĞI 4.8X400	100 ad.	7500	0,171
062 129 008250	EB.07.207 KABLO BAĞI 8X250	100 ad.	6000	0,228
062 129 008300	EB.18.218 KABLO BAĞI 8X300	100 ad.	5000	0,245
062 129 008380	EB.19.219 KABLO BAĞI 8X380	100 ad.	4000	0,293
062 129 008450	EB.21.221 KABLO BAĞI 8X450	100 ad.	3000	0,380
062 129 008550	EB.15.215 KABLO BAĞI 8X550	100 ad.	4000	0,479
062 129 008750	EB.24.224 KABLO BAĞI 8X750	100 ad.	3000	0,717
062 129 009940	EB.22.222 KABLO BAĞI 9X940	100 ad.	1500	1,224
062 129 009762	EB.17.217 KABLO BAĞI 9X762	100 ad.	1500	0,952
062 129 010205	PV.40.205 DELİKLİ KABLO BAĞI 4X205	100 ad.	1500	0,133

KROŞE VE KLİPSLER

062 129 132020	EK.01.1001 YAPIŞKANLI KROŞE 20X20	100 ad.		0,131
062 129 132828	EK.03.1003 YAPIŞKANLI KROŞE 28X28	100 ad.		0,188
062 129 131316	EK.16.1016 YAPIŞKANLI KLİPS 13X16	100 ad.		0,158
062 129 132525	EK.05.1005 YAPIŞKANLI KLİPS 25X25	100 ad.		0,276
062 129 191325	EK.19.1019 YAPIŞKANLI KLİPS 13X25	100 ad.		0,210
062 129 142525	EK.07.1007 YAPIŞKANLI KLİPS 25X25	100 ad.		0,295
062 129 151017	EK.06.1006 VİDALI KROŞE 10X17	250 ad.		0,097
062 129 151723	EK.02.1002 VİDALI KROŞE 17X23	250 ad.		0,122
062 129 151530	EK.13.1013 VİDALI KROŞE 15X30	100 ad.		0,145
062 129 161004	EK.04.1004 DÜBELLİ KROŞE 6 DELİK İÇİN	500 ad.		0,113
062 129 171009	EK.09.1009 DUVAR KROŞESİ 6 DELİK İÇİN	250 ad.		0,118
062 129 171048	EK.10.1010 DÜBELLİ KABLO TUTUCU Q4,8 DELİK İÇİN	250 ad.		0,114
033 129 100008	KANAL KROŞESİ 8 DELİK İÇİN	250 ad.		0,116
062 129 171011	EK.11.1011 KANAL KROŞESİ 6 DELİK İÇİN	250 ad.		0,105

PEMSAN BURMA TİP KELEPÇELER

060 120 005105	EA.05.105 BURMA KELEPÇE	500 ad.		0,068
060 120 007107	EA.07.107 BURMA KELEPÇE	500 ad.		0,082
060 120 010110	EA.10.110 BURMA KELEPÇE	500 ad.		0,088
060 120 014114	EA.14.114 BURMA KELEPÇE	500 ad.		0,114
060 120 017117	EA.17.117 BURMA KELEPÇE	500 ad.		0,142

ETİKETLER

062 129 111035	ET.07.907 KABLO BAĞI ETİKETİ 10X35	100 ad.		0,375
062 129 112045	ET.06.906 KABLO BAĞI ETİKETİ 20X45	100 ad.		0,514
062 129 121530	ET.02.902 YAPIŞKANLI PANO ETİKETİ 17X30	100 ad.		0,449
062 129 121750	ET.03.903 YAPIŞKANLI PANO ETİKETİ 17X50	50 ad.		0,641
062 129 122075	ET.04.904 YAPIŞKANLI PANO ETİKETİ 17X75	25 ad.		0,869

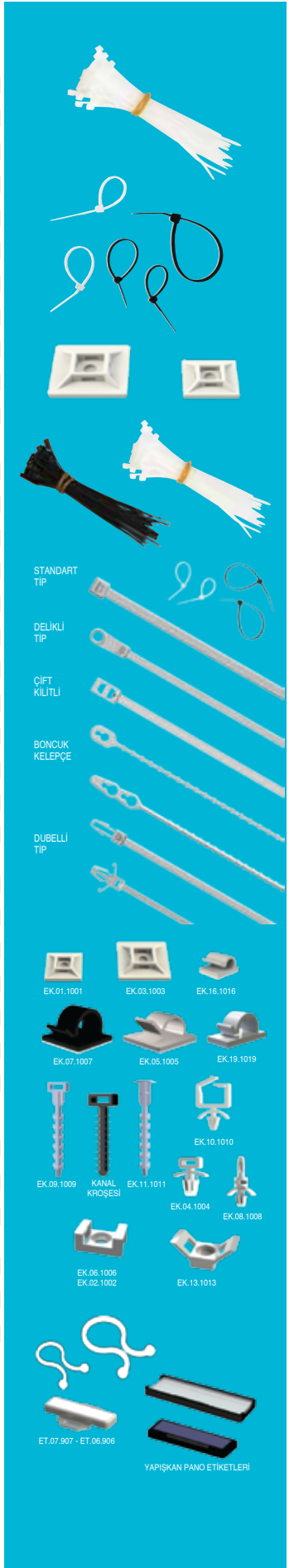



Kod	Açıklama / Stok Cinsi	Amb. (Kutu/Bağ)	Amb. (Koli/Çkt.)	FİYAT
SIKMALI TİP KABLO PAPUÇLARI (İTHAL)				
123 037 000016	16 MM2 SIKMALI TİP KABLO PAPUCU (İTHAL) M6	500 ad.		0,566
123 037 000025	25 MM2 SIKMALI TİP KABLO PAPUCU (İTHAL) M8	350 ad.		1,042
123 037 000035	35 MM2 SIKMALI TİP KABLO PAPUCU (İTHAL) M8	200 ad.		1,444
123 037 000050	50 MM2 SIKMALI TİP KABLO PAPUCU (İTHAL) M10	150 ad.		1,845
123 037 000070	70 MM2 SIKMALI TİP KABLO PAPUCU (İTHAL) M10	100 ad.		3,110
123 037 000095	95 MM2 SIKMALI TİP KABLO PAPUCU (İTHAL) M12	70 ad.		3,631
123 037 000120	120 MM2 SIKMALI TİP KABLO PAPUCU (İTHAL) M12	50 ad.		5,060
123 037 000150	150 MM2 SIKMALI TİP KABLO PAPUCU (İTHAL) M12	40 ad.		8,483
123 037 000185	185 MM2 SIKMALI TİP KABLO PAPUCU (İTHAL) M16	30 ad.		10,120
123 037 000240	240 MM2 SIKMALI TİP KABLO PAPUCU (İTHAL) M16	24 ad.		14,882
123 037 000300	300 MM2 SIKMALI TİP KABLO PAPUCU (İTHAL) M16	20 ad.		18,454

Kod	Açıklama / Stok Cinsi	Amb. (Kutu/Bağ)	Amb. (Koli/Çkt.)	FİYAT
SIKMALI TİP KABLO PAPUÇLARI (STANDART)				
123 037 500010	10 MM2 SIKMALI TİP KABLO PAPUCU (STANDART SERİSİ) M5	800 ad.		0,595
123 037 500016	16 MM2 SIKMALI TİP KABLO PAPUCU (STANDART SERİSİ) M6	500 ad.		0,819
123 037 500025	25 MM2 SIKMALI TİP KABLO PAPUCU (STANDART SERİSİ) M8	350 ad.		1,563
123 037 500035	35 MM2 SIKMALI TİP KABLO PAPUCU (STANDART SERİSİ) M8	200 ad.		2,054
123 037 500050	50 MM2 SIKMALI TİP KABLO PAPUCU (STANDART SERİSİ) M10	150 ad.		2,872
123 037 500070	70 MM2 SIKMALI TİP KABLO PAPUCU (STANDART SERİSİ) M10	100 ad.		4,286
123 037 500095	95 MM2 SIKMALI TİP KABLO PAPUCU (STANDART SERİSİ) M12	70 ad.		5,060
123 037 500120	120 MM2 SIKMALI TİP KABLO PAPUCU (STANDART SERİSİ) M12	50 ad.		7,144
123 037 500150	150 MM2 SIKMALI TİP KABLO PAPUCU (STANDART SERİSİ) M12	40 ad.		11,608
123 037 500185	185 MM2 SIKMALI TİP KABLO PAPUCU (STANDART SERİSİ) M16	30 ad.		14,287
123 037 500240	240 MM2 SIKMALI TİP KABLO PAPUCU (STANDART SERİSİ) M16	24 ad.		19,347
123 037 500300	300 MM2 SIKMALI TİP KABLO PAPUCU (STANDART SERİSİ) M16	20 ad.		24,407

Kod	Açıklama / Stok Cinsi	Amb. (Kutu/Bağ)	Amb. (Koli/Çkt.)	FİYAT
STANDART TİP SIKMALI KABLO EK MUFLARI				
123 037 300010	10 MM2 BORU TİP SIKMALI EK MUFU	800 ad.		0,536
123 037 300016	16 MM2 BORU TİP SIKMALI EK MUFU	350 ad.		0,774
123 037 300025	25MM2 BORU TİP SIKMALI EK MUFU	350 ad.		1,369
123 037 300035	35 MM2 BORU TİP SIKMALI EK MUFU	200 ad.		1,607
123 037 300050	50 MM2 BORU TİP SIKMALI EK MUFU	150 ad.		2,084
123 037 300070	70 MM2 BORU TİP SIKMALI EK MUFU	100 ad.		3,572
123 037 300095	95 MM2 BORU TİP SIKMALI EK MUFU	70 ad.		4,286
123 037 300120	120 MM2 BORU TİP SIKMALI EK MUFU	50 ad.		5,149
123 037 300150	150 MM2 BORU TİP SIKMALI EK MUFU	40 ad.		8,929
123 037 300185	185 MM2 BORU TİP SIKMALI EK MUFU	30 ad.		11,013
123 037 300240	240 MM2 BORU TİP SIKMALI EK MUFU	24 ad.		16,371

Kod	Açıklama / Stok Cinsi	Amb. (Kutu/Bağ)	Amb. (Koli/Çkt.)	FİYAT
MEKANİK SKP SIKMA PENSELERİ				
014 101 000650	JY-0650A MEKANİK SKP SIKMA PENSESİ(6-50)	1 ad.		121,142\$
014 101 000620	JY-06120 MEKANİK SKP SIKMA PENSESİ(6-20)	1 ad.		240,648\$
014 101 025150	JY-25150 MEKANİK SKP SIKMA PENSESİ(25-150)	1 ad.		246,720\$
014 101 070240	JY-70240 MEKANİK SKP SIKMA PENSESİ(70-240)	1 ad.		265,204\$

Kod	Açıklama / Stok Cinsi	Amb. (Kutu/Bağ)	Amb. (Koli/Çkt.)	FİYAT
HİDROLİK SKP SIKMA PENSELERİ				
014 101 004070	YQK-70 HİDROLİK SKP SIKMA PENSESİ (4-70)	1 ad.		187,518\$
014 101 010120	YYQ-120 HİDROLİK SKP SIKMA PENSESİ (10-120)	1 ad.		205,376\$
014 101 016240	YQK-240 HİDROLİK SKP SIKMA PENSESİ (16-240)	1 ad.		227,700\$
014 101 016300	YQK-300 HİDROLİK SKP SIKMA PENSESİ (16-300)	1 ad.		251,512\$

Kod	Açıklama / Stok Cinsi	Amb. (Kutu/Bağ)	Amb. (Koli/Çkt.)	FİYAT
YÜKSÜK VE İZOLELİ KABLO UCU SIKMA PENSELERİ				
014 101 005056	YAC-5 YÜKSÜK SIKMA PENSESİ(0,5-6)	1 ad.		76,871\$
014 101 006616	YAC-6 YÜKSÜK SIKMA PENSESİ(6-16)	1 ad.		92,228\$
014 101 008056	YAC-8 YÜKSÜK SIKMA PENSESİ(0,5-6)(İZOLESİZ KABLO UCU)	1 ad.		133,322\$
014 101 001056	YYT-1 İZOLELİ KABLO UCU SIKMA PENSESİ(0,5-6)	1 ad.		74,687\$
014 101 011014	YYT-11 İZOLESİZ KABLO UCU SIKMA PENSESİ(1-4)	1 ad.		86,479\$

Kod	Açıklama / Stok Cinsi	Amb. (Kutu/Bag)	Amb. (Kali/Çet.)	FİYAT
İZOLELİ TEK GİRİŞLİ YÜKSÜK				
014 100 010508	ITY-0508 İZO.TEK GİRİŞ. YÜKSÜK 0,50 MM	500 ad.		0,017\$
014 100 017508	ITY-7508 İZO.TEK GİRİŞ. YÜKSÜK 0,75 MM	1000 ad.		0,017\$
014 100 011008	ITY-1008 İZO.TEK GİRİŞ. YÜKSÜK 1,00 MM	1000 ad.		0,017\$
014 100 011508	ITY-1508 İZO.TEK GİRİŞ. YÜKSÜK 1,50 MM	1000 ad.		0,017\$
014 100 012508	ITY-2508 İZO.TEK GİRİŞ. YÜKSÜK 2,50 MM	500 ad.		0,022\$
014 100 014009	ITY-4009 İZO.TEK GİRİŞ. YÜKSÜK 4,00 MM	500 ad.		0,037\$
014 100 016012	ITY-6012 İZO.TEK GİRİŞ. YÜKSÜK 6,00 MM	250 ad.		0,050\$
014 100 011012	ITY-1012 İZO.TEK GİRİŞ. YÜKSÜK 10,00 MM	100 ad.		0,066\$
014 100 011612	ITY-1612 İZO.TEK GİRİŞ. YÜKSÜK 16,00 MM	100 ad.		0,100\$
014 100 012516	ITY-2516 İZO.TEK GİRİŞ. YÜKSÜK 25,00 MM	50 ad.		0,193\$
014 100 013516	ITY-3516 İZO.TEK GİRİŞ. YÜKSÜK 35,00 MM	40 ad.		0,260\$
014 100 015020	ITY-5020 İZO.TEK GİRİŞ. YÜKSÜK 50,00 MM	20 ad.		0,377\$
İZOLELİ ÇİFT GİRİŞLİ YÜKSÜK				
014 100 020508	ICY-0508 İZO.ÇİFT GİRİŞ. YÜKSÜK 2X0,5 MM	500 ad.		0,038\$
014 100 027508	ICY-7508 İZO.ÇİFT GİRİŞ. YÜKSÜK 2X0,75MM	500 ad.		0,038\$
014 100 021008	ICY-1008 İZO.ÇİFT GİRİŞ. YÜKSÜK 2X1 MM	500 ad.		0,038\$
014 100 021508	ICY-1508 İZO.ÇİFT GİRİŞ. YÜKSÜK 2X1,5 MM	500 ad.		0,039\$
014 100 022510	ICY-2510 İZO.ÇİFT GİRİŞ. YÜKSÜK 2X2,5 MM	250 ad.		0,047\$
014 100 024012	ICY-4012 İZO.ÇİFT GİRİŞ. YÜKSÜK 2X4 MM	100 ad.		0,140\$
014 100 026014	ICY-6014 İZO.ÇİFT GİRİŞ. YÜKSÜK 2X6 MM	100 ad.		0,148\$
İZOLELİ YUVARLAK TİP PAPAÇ				
014 100 030154	IYP-1,5-4 İZO.YUV.TİP PAP. 0,5-1,5MM(M4)	200 ad.		0,047\$
014 100 030155	IYP-1,5-5 İZO.YUV.TİP PAP. 0,5-1,5MM(M5)	200 ad.		0,054\$
014 100 030156	IYP-1,5-6 İZO.YUV.TİP PAP. 0,5-1,5MM(M6)	200 ad.		0,069\$
014 100 030158	IYP-1,5-8 İZO.YUV.TİP PAP. 0,5-1,5MM(M8)	200 ad.		0,075\$
014 100 030254	IYP-2,5-4 İZO.YUV.TİP PAP. 1,5-2,5MM(M4)	200 ad.		0,055\$
014 100 030255	IYP-2,5-5 İZO.YUV.TİP PAP. 1,5-2,5MM(M5)	200 ad.		0,056\$
014 100 030256	IYP-2,5-6 İZO.YUV.TİP PAP. 1,5-2,5MM(M6)	200 ad.		0,081\$
014 100 030258	IYP-2,5-8 İZO.YUV.TİP PAP. 1,5-2,5MM(M8)	200 ad.		0,081\$
014 100 036004	IYP-6-4 İZO.YUV.TİP PAP. 4-6MM(M4)	100 ad.		0,094\$
014 100 036005	IYP-6-5 İZO.YUV.TİP PAP. 4-6 MM(M5)	100 ad.		0,119\$
014 100 036006	IYP-6-6 İZO.YUV.TİP PAP. 4-6MM(M6)	100 ad.		0,138\$
014 100 036008	IYP-6-8 İZO.YUV.TİP PAP. 4-6MM(M8)	100 ad.		0,155\$
İZOLELİ ÇATAL TİP PAPAÇ				
014 100 040154	ICP-1,5-4 İZO.ÇTL.TİP PAP. 0,5-1,5MM(M4)	200 ad.		0,051\$
014 100 040155	ICP-1,5-5 İZO.ÇTL.TİP PAP. 0,5-1,5MM(M5)	200 ad.		0,059\$
014 100 040156	ICP-1,5-6 İZO.ÇTL.TİP PAP. 0,5-1,5MM(M6)	200 ad.		0,069\$
014 100 040254	ICP-2,5-4 İZO.ÇTL.TİP PAP. 0,5-1,5MM(M4)	200 ad.		0,054\$
014 100 040255	ICP-2,5-5 İZO.ÇTL.TİP PAP. 0,5-1,5MM(M5)	200 ad.		0,059\$
014 100 040256	ICP-2,5-6 İZO.ÇTL.TİP PAP. 0,5-1,5MM(M6)	200 ad.		0,074\$
014 100 046004	ICP-6-4 İZO.ÇTL.TİP PAP. 4-6 MM(M4)	100 ad.		0,111\$
014 100 046005	ICP-6-5 İZO.ÇTL.TİP PAP. 4-6 MM(M5)	100 ad.		0,117\$
014 100 046006	ICP-6-6 İZO.ÇTL.TİP PAP. 4-6 MM(M6)	100 ad.		0,124\$
İZOLELİ İĞNE TİP TERMİNAL				
014 100 050015	IIT-1,5 İZOLELİ İĞNE TİP TERM.0,5-1,5MM	200 ad.		0,057\$
014 100 050025	IIT-2,5 İZOLELİ İĞNE TİP TERM.1,5-2,5MM	200 ad.		0,063\$
014 100 050040	IIT-4 İZOLELİ İĞNE TİP TERM.4-6MM	100 ad.		0,124\$
İZOLELİ EK MUF				
014 100 070015	IEM-1,5 İZOLELİ EK MUF 0,5-1,5 MM	100 ad.		0,063\$
014 100 070025	IEM-2,5 İZOLELİ EK MUF 1,5-2,5 MM	100 ad.		0,069\$
014 100 070040	IEM-4 İZOLELİ EK MUF 4-6 MM	100 ad.		0,110\$
İZOLELİ FASTON ERKEK TERMİNAL				
014 100 060015	IFE-1,5 İZO. FASTON ERK. TERM. 1,5 MM	200 ad.		0,110\$
014 100 060025	IFE-2,5 İZO. FASTON ERK. TERM. 2,5 MM	200 ad.		0,110\$
014 100 060040	IFE-4 İZO. FASTON ERK. TERM. 4 MM	100 ad.		0,160\$
İZOLELİ FASTON DIŞI TERMİNAL				
014 100 080510	IDT-0,5-1 İZO. FASTON DIŞI TERM. 0,5-1MM	200 ad.		0,110\$
014 100 081525	IDT-1,5-2,5 İZO.FASTON DIŞI TERM. 1,5-2,5MM	200 ad.		0,110\$
014 100 084060	IDT-4-6 İZO. FASTON DIŞI TERM. 4-6 MM	100 ad.		0,160\$
TAM İZOLELİ DIŞI TERMİNAL				
014 100 090510	TDT-0,5-1 TAM İZO.DIŞI TERM. 0,5-1 MM	200 ad.		0,110\$
014 100 091525	TDT-1,5-2,5 TAM İZO.DIŞI TERM.1,5-2,5 MM	150 ad.		0,110\$
014 100 094060	TDT-4-6 TAM İZO.DIŞI TERM. 4-6 MM	100 ad.		0,170\$
YUVARLAK DIŞI TERMİNAL				
014 100 100510	YDT-0,5-1 YUV. DIŞI TERM. 0,5-1 MM	200 ad.		0,110\$
014 100 101525	YDT-1,5-2,5 YUV. DIŞI TERM. 1,5-2,5 MM	200 ad.		0,110\$
014 100 104060	YDT-4-6 YUV. DIŞI TERM. 4-6 MM	100 ad.		0,170\$
YUVARLAK ERKEK TERMİNAL				
014 100 110510	YET-0,5-1 YUV. ERKEK TERM. 0,5-1 MM	200 ad.		0,074\$
014 100 111525	YET-1,5-2,5 YUV. ERKEK TERM.1,5-2,5 MM	200 ad.		0,079\$
014 100 114060	YET-4-6 YUV. ERKEK TERM. 4-6 MM	100 ad.		0,139\$
FASTON TİP TERMİNALER İZOLELİ				
065 100 140003	TSF-1-D 6,3 FASTON TİP TERMİNAL	200 ad.		0,040\$
065 100 140002	TSF-1-D MİNİ 4,8 FASTON TİP TERMİNAL	200 ad.		0,049\$
065 100 140001	TSF-1-D GÜMÜŞ FASTON TİP TERMİNAL	200 ad.		0,055\$
065 100 140004	TSF-1-E FASTON TİP TERMİNAL	200 ad.		0,040\$

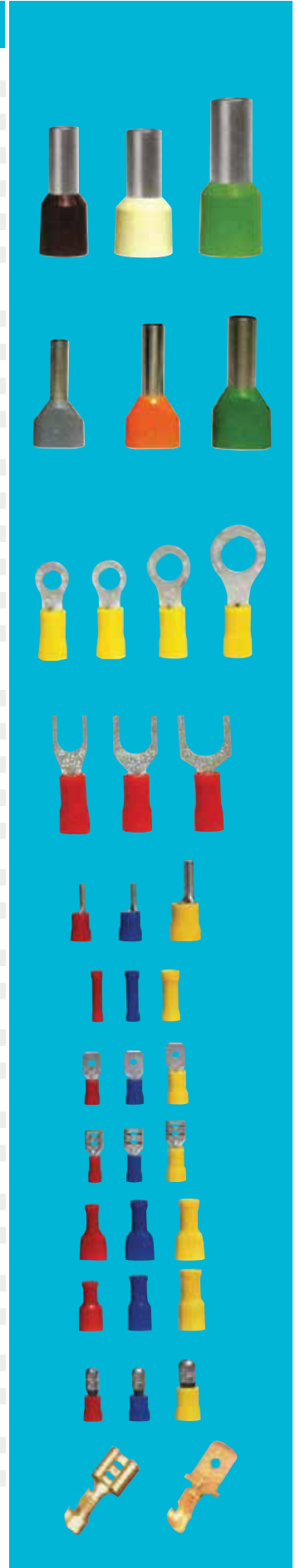

MUTLUSAN SİNYAL ve KUMANDA BUTONLARI



ÜRÜN KODU
010 090 010001
ÜRÜN ADI
10MM KABLOLU
SİNYAL ARMATÜRÜ
AMBALAJ ADET / KOLİ
100
FİYAT
1,786 TL



ÜRÜN KODU
010 090 010010
ÜRÜN ADI
22MM SİNYAL
ARMATÜRÜ 220V
AMBALAJ ADET / KOLİ
24
FİYAT
2,917 TL



ÜRÜN KODU
010 090 040002
ÜRÜN ADI
YAYLI STOP
BUTONU
AMBALAJ ADET / KOLİ
20
FİYAT
6,846 TL



ÜRÜN KODU
010 090 010005
ÜRÜN ADI
14MM SİNYAL
ARMATÜRÜ 12V
AMBALAJ ADET / KOLİ
50
FİYAT
2,679 TL



ÜRÜN KODU
010 090 010002
ÜRÜN ADI
BA9S DUYLU LEDLİ
22MM SİN. ARM. 220V
AMBALAJ ADET / KOLİ
24
FİYAT
6,078 TL



ÜRÜN KODU
010 090 050004
ÜRÜN ADI
BA9S NEON AMPÜLLÜ
YAYLI IŞIKLI STR.BUT.
AMBALAJ ADET / KOLİ
20
FİYAT
14,882 TL



ÜRÜN KODU
010 090 010006
ÜRÜN ADI
14MM SİNYAL
ARMATÜRÜ 24V
AMBALAJ ADET / KOLİ
50
FİYAT
2,679 TL



ÜRÜN KODU
010 090 010003
ÜRÜN ADI
BA9S DUYLU NEON
22MM SİN.ARM. 220V
AMBALAJ ADET / KOLİ
24
FİYAT
4,167 TL



ÜRÜN KODU
010 090 050006
ÜRÜN ADI
BA9S NEON AMPÜLLÜ
YAYLI IŞIKLI STP.BUT.
AMBALAJ ADET / KOLİ
20
FİYAT
14,882 TL



ÜRÜN KODU
010 090 010007
ÜRÜN ADI
14MM SİNYAL
ARMATÜRÜ 220V
AMBALAJ ADET / KOLİ
50
FİYAT
2,381 TL



ÜRÜN KODU
010 090 010004
ÜRÜN ADI
22MM SİNYAL ARM.
220V LEDLİ
AMBALAJ ADET / KOLİ
24
FİYAT
4,876 TL



ÜRÜN KODU
010 090 050003
ÜRÜN ADI
BA9S LEDLİ YAYLI
IŞIKLI START BUTONU
AMBALAJ ADET / KOLİ
20
FİYAT
17,859 TL



ÜRÜN KODU
010 090 010008
ÜRÜN ADI
22MM SİNYAL
ARMATÜRÜ 12V
AMBALAJ ADET / KOLİ
24
FİYAT
3,125 TL



ÜRÜN KODU
010 090 070002
ÜRÜN ADI
22MM SİNYAL
ARMATÜRÜ 24V LEDLİ
AMBALAJ ADET / KOLİ
24
FİYAT
5,722 TL



ÜRÜN KODU
010 090 050005
ÜRÜN ADI
BA9S LEDLİ YAYLI
IŞIKLI STOP BUTONU
AMBALAJ ADET / KOLİ
20
FİYAT
17,859 TL



ÜRÜN KODU
010 090 010009
ÜRÜN ADI
22MM SİNYAL
ARMATÜRÜ 24V
AMBALAJ ADET / KOLİ
24
FİYAT
3,125 TL



ÜRÜN KODU
010 090 040001
ÜRÜN ADI
YAYLI START
BUTONU
AMBALAJ ADET / KOLİ
20
FİYAT
6,846 TL



ÜRÜN KODU
010 090 040005
ÜRÜN ADI
YAYLI MANTAR KAFA
BUTON STOP
AMBALAJ ADET / KOLİ
12
FİYAT
8,929 TL

MUTLUSAN SİNYAL ve KUMANDA BUTONLARI

ÜRÜN KODU
010 090 040003
ÜRÜN ADI
YAYLI MANTAR KAFA
BUTON START
AMBALAJ ADET / KOLİ
12
FİYAT
8,929 TL



ÜRÜN KODU
010 090 050001
ÜRÜN ADI
ACİL STOP BUTONU
(30'LİK)
AMBALAJ ADET / KOLİ
12
FİYAT
11,929 TL



ÜRÜN KODU
010 090 030007
ÜRÜN ADI
SEÇİCİ BUTON 0-1
ANAHTARLI
AMBALAJ ADET / KOLİ
12
FİYAT
25,189 TL



ÜRÜN KODU
010 090 030003
ÜRÜN ADI
BA9S LEDLİ IŞIKLI
SEÇİCİ BUTON 0-1
AMBALAJ ADET / KOLİ
12
FİYAT
20,538 TL



ÜRÜN KODU
010 090 050002
ÜRÜN ADI
ACİL STOP BUTONU
(40'LİK)
AMBALAJ ADET / KOLİ
12
FİYAT
11,929 TL



ÜRÜN KODU
010 090 030008
ÜRÜN ADI
SEÇİCİ BUTON 11-0-1
ANAHTARLI
AMBALAJ ADET / KOLİ
12
FİYAT
28,276 TL



ÜRÜN KODU
010 090 030004
ÜRÜN ADI
BA9S LEDLİ IŞIKLI
SEÇİCİ BUTON 11-0-1
AMBALAJ ADET / KOLİ
12
FİYAT
25,002 TL



ÜRÜN KODU
010 090 040007
ÜRÜN ADI
YAYLI İKİZ
BUTON
AMBALAJ ADET / KOLİ
14
FİYAT
17,412 TL



ÜRÜN KODU
010 090 050007
ÜRÜN ADI
ANAHTARLI ACİL STOP
BUTONU (40'LİK)
AMBALAJ ADET / KOLİ
12
FİYAT
26,788 TL



ÜRÜN KODU
010 090 020002
ÜRÜN ADI
ESKİ TİP START-STOP
BUTONU ÇİFT KONTAK
AMBALAJ ADET / KOLİ
20
FİYAT
5,938 TL



ÜRÜN KODU
010 090 040006
ÜRÜN ADI
YAYLI IŞIKLI İKİZ
BUTON
AMBALAJ ADET / KOLİ
14
FİYAT
22,324 TL



ÜRÜN KODU
010 091 020002
ÜRÜN ADI
YÖN IŞARETLİ START
BUTONU
AMBALAJ ADET / KOLİ
20
FİYAT
7,441 TL



ÜRÜN KODU
010 090 020001
ÜRÜN ADI
ESKİ TİP START
BUTONU TEK KONTAK
AMBALAJ ADET / KOLİ
20
FİYAT
4,750 TL



ÜRÜN KODU
010 090 030001
ÜRÜN ADI
SEÇİCİ BUTON
0-1
AMBALAJ ADET / KOLİ
12
FİYAT
10,418 TL



ÜRÜN KODU
010 111 070001
ÜRÜN ADI
BUZZER 220 VOLT
LEDLİ
AMBALAJ ADET / KOLİ
24
FİYAT
17,859 TL



ÜRÜN KODU
010 090 020003
ÜRÜN ADI
ESKİ TİP STOP BUTONU
TEK KONTAK
AMBALAJ ADET / KOLİ
20
FİYAT
4,750 TL



ÜRÜN KODU
010 090 030002
ÜRÜN ADI
SEÇİCİ BUTON
11-0-1
AMBALAJ ADET / KOLİ
12
FİYAT
14,882 TL



ÜRÜN KODU
010 111 070002
ÜRÜN ADI
BUZZER 24 VOLT
LEDLİ
AMBALAJ ADET / KOLİ
24
FİYAT
16,966 TL

MUTLUSAN SİNYAL ve KUMANDA BUTONLARI



ÜRÜN KODU
010 111 070003
ÜRÜN ADI
BUZZER
220 VOLT
AMBALAJ ADET / KOLİ
24
FİYAT
16,073 TL



ÜRÜN KODU
010 093 000003
ÜRÜN ADI
ACİL DURDURMA
ETİKETİ
AMBALAJ ADET / KOLİ
50
FİYAT
3,902 TL



ÜRÜN KODU
010 093 000002
ÜRÜN ADI
BUTON ETİKETİ
AMBALAJ ADET / KOLİ
50
FİYAT
0,893 TL



ÜRÜN KODU
010 111 070004
ÜRÜN ADI
BUZZER
24 VOLT
AMBALAJ ADET / KOLİ
24
FİYAT
15,180 TL



ÜRÜN KODU
010 090 050008
ÜRÜN ADI
EMNİYET BASMA
DÜĞMESİ MUHAFAZA
AMBALAJ ADET / KOLİ
50
FİYAT
1,935 TL



ÜRÜN KODU
010 093 000004
ÜRÜN ADI
YEDEK KONTAK
BLOK
AMBALAJ ADET / KOLİ
50
FİYAT
4,465 TL



ÜRÜN KODU
010 090 030005
ÜRÜN ADI
BA9S NEON AMPÜLLÜ
IŞIKLI SEÇ.BUT. 0-1
AMBALAJ ADET / KOLİ
12
FİYAT
17,859 TL



ÜRÜN KODU
010 093 000001
ÜRÜN ADI
SİLİKON TOZ
KILIFI
AMBALAJ ADET / KOLİ
50
FİYAT
2,976 TL



ÜRÜN KODU
010 093 000005
ÜRÜN ADI
IŞIK SOKETİ
AMBALAJ ADET / KOLİ
20
FİYAT
4,018 TL



ÜRÜN KODU
010 090 030006
ÜRÜN ADI
BA9S NEON AMPÜLLÜ
IŞIKLI SEÇ.BUT. 11-0-1
AMBALAJ ADET / KOLİ
12
FİYAT
22,324 TL

VİNÇ KUTULARI



ÜRÜN KODU
010 092 000001
ÜRÜN ADI
İKİLİ VİNÇ KUTUSU
(TEK HIZLI)
AMBALAJ ADET / KOLİ
1
FİYAT
71,435 TL



ÜRÜN KODU
010 092 000003
ÜRÜN ADI
DÖRTLÜ VİNÇ KUTUSU
(TEK HIZLI)
AMBALAJ ADET / KOLİ
1
FİYAT
110,129 TL



ÜRÜN KODU
010 092 000005
ÜRÜN ADI
ALTILI VİNÇ KUTUSU
(TEK HIZLI)
AMBALAJ ADET / KOLİ
1
FİYAT
148,824 TL



ÜRÜN KODU
010 092 000002
ÜRÜN ADI
ÜÇLÜ VİNÇ KUTUSU
(TEK HIZLI)
AMBALAJ ADET / KOLİ
1
FİYAT
86,318 TL



ÜRÜN KODU
010 092 000004
ÜRÜN ADI
BEŞLİ VİNÇ KUTUSU
(TEK HIZLI)
AMBALAJ ADET / KOLİ
1
FİYAT
125,012 TL



ÜRÜN KODU
010 092 000006
ÜRÜN ADI
YEDİLİ VİNÇ KUTUSU
(TEK HIZLI)
AMBALAJ ADET / KOLİ
1
FİYAT
163,706 TL

EUROBOX ETANJ BUTON KUTULARI (YENİ MODEL)

 <p>ÜRÜN KODU 010 091 010001 ÜRÜN ADI 1 Lİ ETANJ BUTON KUTUSU AMBALAJ ADET / KOLİ 24 FİYAT 7,888 TL</p>	 <p>ÜRÜN KODU 010 091 010003 ÜRÜN ADI 3 LÜ ETANJ BUTON KUTUSU AMBALAJ ADET / KOLİ 12 FİYAT 12,501 TL</p>	 <p>ÜRÜN KODU 010 090 050009 ÜRÜN ADI TEKLİ ACİL STOPLU KUTU AMBALAJ ADET / KOLİ 18 FİYAT 20,835 TL</p>
 <p>ÜRÜN KODU 010 091 010002 ÜRÜN ADI 2 Lİ ETANJ BUTON KUTUSU AMBALAJ ADET / KOLİ 18 FİYAT 9,525 TL</p>	 <p>ÜRÜN KODU 010 091 010004 ÜRÜN ADI 4 LÜ ETANJ BUTON KUTUSU AMBALAJ ADET / KOLİ 10 FİYAT 13,989 TL</p>	 <p>ÜRÜN KODU 010 091 020001 ÜRÜN ADI ASANSÖR REVİZYON 4'LÜ KUTU AMBALAJ ADET / KOLİ 6 FİYAT 56,553 TL</p>

ASANSÖR KUYU DİBİ SETLERİ VE KUMANDALARI

 <p>ÜRÜN KODU 010 091 020024 ÜRÜN ADI 1 Lİ ASANSÖR KUYU DİBİ BUTONU ALARM BUTONU(NO) AMBALAJ ADET / KOLİ 20 FİYAT 14.88 TL</p>	 <p>ÜRÜN KODU 010 091 020025 ÜRÜN ADI 2 Lİ ASANSÖR KUYU DİBİ BUTONU 220V 16A TOPRAKLI PRİZ+ACİL STOP BUTON AMBALAJ ADET / KOLİ 10 FİYAT 26.79 TL</p>	 <p>ÜRÜN KODU 010 091 020026 ÜRÜN ADI 3 LÜ ASANSÖR KUYU DİBİ BUTONU 220V 16A TOP.PRİZ+ACİL STOP BUTON+01 SEÇİCİ BUTON(NO+NC) AMBALAJ ADET / KOLİ 6 FİYAT 46.14 TL</p>
 <p>ÜRÜN KODU 010 091 020027 ÜRÜN ADI 4 LÜ ASANSÖR KUYU DİBİ BUTONU 220V 16A TOP.PRİZ+ACİL STOP BUT.+01 SEÇİCİ BUT.+ (NO+NC) START BUT. AMBALAJ ADET / KOLİ 6 FİYAT 55.06 TL</p>	 <p>ÜRÜN KODU 010 091 020028 ÜRÜN ADI 5 Lİ KORUMALI REVİZYON KUTUSU ACİL STOP BUT.+2 ADET OKLU BUT.+1 ORT. KULL. BUTON+SEÇİCİ BUTON AMBALAJ ADET / KOLİ 2 FİYAT 66.97 TL</p>	 <p>ÜRÜN KODU 010 091 020029 ÜRÜN ADI 6 Lİ KORUMALI REVİZYON KUTUSU ACİL STOP BUT.+2AD. OKLU BUT. +1OR. KULL. BUT. + SEÇİCİ BUT.+ALARM BUT. AMBALAJ ADET / KOLİ 2 FİYAT 74.41 TL</p>



ASANSÖR PANOLARI

010 091 020003	ASANSÖR REVİZYON KUTUSU (BOŞ)	1 ad.	148,824
010 091 020010	5X40 ASANSÖR BESLEME PANOSU(5X40 AMP.PAKO+4X40 AMP.K.A.K+4X40 SIG.+2X25 AMP.K.A.K+3AD.X1X16 AMP.SIG. ŞALT OTOM.AOG	1 ad.	730,588
010 091 020011	5X63 ASANSÖR BESLEME PANOSU(5X63 AMP.PAKO+4X63 AMP.K.A.K+4X63 SIG.+2X25 AMP.K.A.K+3AD.X1X16 AMP.SIG. ŞALT OTOM.AOG	1 ad.	771,176
010 091 020012	6X40 ASANSÖR BESLEME PANOSU(6X40 AMP.PAKO+4X40 AMP.K.A.K+4X40 SIG.+2X25 AMP.K.A.K+3AD.X1X16 AMP.SIG. ŞALT OTOM.AOG	1 ad.	771,176
010 091 020013	6X63 ASANSÖR BESLEME PANOSU(6X63 AMP.PAKO+4X63 AMP.K.A.K+4X63 SIG.+2X25 AMP.K.A.K+3AD.X1X16 AMP.SIG. ŞALT OTOM.AOG	1 ad.	811,765
010 091 020020	5X40 ASANSÖR BESLEME PANOSU(5X40 AMP.PAKO+4X40 AMP.K.A.K+4X40 SIG.+2X25 AMP.K.A.K+3AD.X1X16 AMP.SIG. ŞALT OTOM.SIEMENS	1 ad.	1.158,118
010 091 020021	5X63 ASANSÖR BESLEME PANOSU(5X63 AMP.PAKO+4X63 AMP.K.A.K+4X63 SIG.+2X25 AMP.K.A.K+3AD.X1X16 AMP.SIG. ŞALT OTOM.SIEMENS	1 ad.	1.271,765
010 091 020022	6X40 ASANSÖR BESLEME PANOSU(6X40 AMP.PAKO+4X40 AMP.K.A.K+4X40 SIG.+2X25 AMP.K.A.K+3AD.X1X16 AMP.SIG. ŞALT OTOM.SIEMENS	1 ad.	1.196,000
010 091 020023	6X63 ASANSÖR BESLEME PANOSU(6X63 AMP.PAKO+4X63 AMP.K.A.K+4X63 SIG.+2X25 AMP.K.A.K+3AD.X1X16 AMP.SIG. ŞALT OTOM.SIEMENS	1 ad.	1.312,353

GÜNEŞ ENERJİLİ SOLAR İKAZ LAMBASI

2 yıl garantili
Rf dalga yaymaz
Stabilize ışık çıkışı
12 yıl uzun ömürlü
Uv ışınlarına karşı dayanıklı
Görünebilirlik mesafesi 10 km
Her türlü yüzeye kolay montaj
Sabit, flaşör, çakar, döner çalışma fonksiyonları
Foto sensör yardımıyla gece ve gündüz algılama



007 087 400106 007 087 400107 007 087 400108

**AIRCRAFT
İL-XCF- SERİSİ**



**MULTİ Serisi
Standart ve Şarjlı İkaz Lambaları**



007 087 400101 007 087 400105

2 yıl garantili
Stabilize ışık çıkışı
Her türlü yüzeye kolay montaj
Sabit, flaşör, çakar ve döner çalışma fonksiyonları

Multi serisi ile
tek gövdede 4 ayrı seçenek



İL-X SERİSİ Ø90mm GÜNEŞ ENERJİ "SOLAR PANEL" İKAZ LAMBALARI

ÜRÜN KODU	ÇALIŞMA ŞEKLİ	BESLEME GERİLİMİ	MODEL	FİYAT
-----------	---------------	------------------	-------	-------

T100 SOLAR İKAZ LAMBASI

007 087 400106	ÇAKAR	12V	İL-XSLR-912V-TMK	160,000 \$
----------------	-------	-----	------------------	------------

T100 SOLAR KULE İKAZ LAMBASI SETİ

007 087 400107	ÇAKAR	12V	İL-XSL05M-TMK	491,118 \$
----------------	-------	-----	---------------	------------

T120 SOLAR AYAKLI İKAZ LAMBASI SETİ

007 087 400108	ÇAKAR	12V	İL-XSL20M-KMK	500,000 \$
----------------	-------	-----	---------------	------------

HAVALANDIRMA ARAÇLARI İÇİN "ANEX 14" SERTİFİKALI İKAZ LAMBASI

ÜRÜN KODU	ÇALIŞMA ŞEKLİ	BESLEME GERİLİMİ	MODEL	FİYAT
-----------	---------------	------------------	-------	-------

129 087 000439	FLAŞÖR	220V AC	İL-XACF22	300,000 \$
129 087 000440	FLAŞÖR	24V AC/DC	İL-XACF24	300,000 \$

İL-X...VT9 SERİSİ MULTİ VE ŞARJLI İKAZ LAMBALARI

ÜRÜN KODU	ÇALIŞMA ŞEKLİ	BESLEME GERİLİMİ	MODEL	FİYAT
-----------	---------------	------------------	-------	-------

T90 ŞARJLI SERİ TEK GÖVDE 4 FARKLI ÇALIŞMA ÖZELLİĞİ

007 087 400105	Multi	12V	İL-XJM-MM9-12K	158,824 \$
----------------	-------	-----	----------------	------------

T90 PİLLİ SERİ TEK GÖVDE 4 FARKLI ÇALIŞMA ÖZELLİĞİ

007 087 400109	Multi	12V	İL-XPM-MM9-12K	142,500 \$
----------------	-------	-----	----------------	------------

T90 SENSÖRLÜ SERİ TEK GÖVDE 4 FARKLI ÇALIŞMA ÖZELLİĞİ

007 087 400110	Multi	12V	İL-XFT-MM9-24K	145,500 \$
007 087 400111	Multi	12V	İL-XFT-MM9-220K	160,500 \$
007 087 400112	Multi+Buzzer	12V	İL-XFTB-MM9-24K	160,00 \$
007 087 400113	Multi+Buzzer	12V	İL-XFTB-MM9-220K	175,00 \$



RENKLER ■ ■ ■ ■ ■

IL-X....VT6 SERİSİ TEK GÖVDE'DE 5 RENK İKAZ LAMBALARI

ÜRÜN KODU	ÇALIŞMA ŞEKLİ	BESLEME GERİLİMİ	MODEL	FİYAT
IL-XP..-VT6 Serisi İkaz Lambaları				
129 087 000431	Sabit Işıklı	24VDC	IL-XLS-VT6-243-A2	42,353 \$
129 087 000432	Sabit Işıklı	220VAC	IL-XLS-VT6-2203-A2	47,647 \$
129 087 000433	Flaşörlü	24VDC	IL-XLF-VT6-243-A2	47,647 \$
129 087 000434	Flaşörlü	220VAC	IL-XLF-VT6-2203-A2	52,941 \$
129 087 000435	Çakar	24VDC	IL-XLÇ-VT6-243-A2	52,941 \$
129 087 000436	Çakar	220VAC	IL-XLÇ-VT6-2203-A2	58,235 \$

IL-XP..-VT6 Serisi Buzzerli İkaz Lambaları

129 087 000412	Sabit Işıklı +Buzzer	24VDC	IL-XLSB-VT6-243-A2	47,647 \$
129 087 000413	Sabit Işıklı +Buzzer	220VAC	IL-XLSB-VT6-2203-A2	52,941 \$
129 087 000414	Flaşörlü +Buzzer	24VDC	IL-XLFB-VT6-243-A2	52,941 \$
129 087 000415	Flaşörlü +Buzzer	220VAC	IL-XLFB-VT6-2203-A2	58,235 \$
129 087 000416	Çakar +Buzzer	24VDC	IL-XLÇB-VT6-243-A2	58,235 \$
129 087 000417	Çakar +Buzzer	220VAC	IL-XLÇB-VT6-2203-A2	80,365 \$
129 087 000418	Konnektörlü tipler için güç konnektörü		IL-XM125	21,176 \$

NOT: Rekor montajlı ürün taleplerinizde yukarıda belirtilen kodlarda yer alan VT6 yerine VR6 getirerek ürün seçimi yapabilirsiniz. Fiyat değişmez.

IL-X....F7 SERİSİ 12... 80 V/DC MOBİL UYGULAMA İÇİN İKAZ LAMBALARI

ÜRÜN KODU	ÇALIŞMA ŞEKLİ	BESLEME GERİLİMİ	MODEL	FİYAT
IL-XP..-F7 Serisi İkaz Lambaları				
129 087 000419	Sabit Işıklı	12...80VDC	IL-XS-F7-80-A2	42,353 \$
129 087 000420	Sabit Işıklı	220VAC	IL-XS-F7-220-A2	47,647 \$
129 087 000421	Flaşörlü	12...80VDC	IL-XF-F7-80-A2	47,647 \$
129 087 000422	Flaşörlü	220VAC	IL-XF-F7-220-A2	52,941 \$
129 087 000423	Çakar	12...80VDC	IL-XÇ-F7-80-A2	52,941 \$
129 087 000424	Çakar	220VAC	IL-XÇ-F7-220-A2	58,235 \$

IL-XP..-F7 Serisi Buzzerli İkaz Lambaları

129 087 000425	Sabit Işıklı +Buzzer	12...80VDC	IL-XSB-F7-80-A2	47,647 \$
129 087 000426	Sabit Işıklı +Buzzer	220VAC	IL-XSB-F7-220-A2	52,941 \$
129 087 000427	Flaşörlü +Buzzer	12...80VDC	IL-XFB-F7-80-A2	52,941 \$
129 087 000428	Flaşörlü +Buzzer	220VAC	IL-XFB-F7-220-A2	54,023 \$
129 087 000429	Çakar +Buzzer	12...80VDC	IL-XÇB-F7-80-A2	58,235 \$
129 087 000430	Çakar +Buzzer	220VAC	IL-XÇB-F7-220-A2	63,529 \$



Temperature



High IP value



Shock /
Vibration
resistant



Magnetic
field proof



Power
LED Light

İşıklı kolonlarda kırmızı sabit renktir. Diğer renkler siparişle yapılabilmektedir.



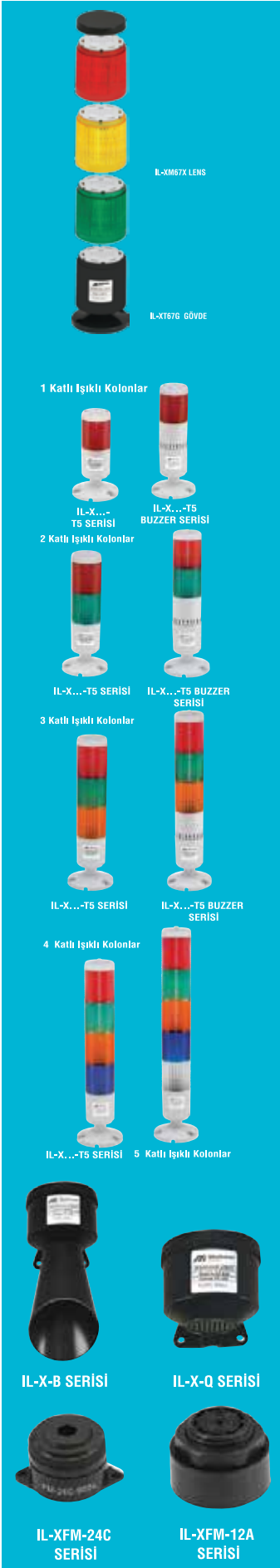

Kod	Açıklama / Stok Cinsi	Çalışma Şekli	Montaj Şekli	Besleme Gerilimi	Armb. Birimi	FİYAT
İL-XM67 SERİSİ Q67 MODÜLER SİSTEM İKAZ LAMBA LENSLERİ						
129 087 000015	İL-XM67S-24	SABİT İŞİK	TABANA MONTAJ	24V AC/DC	1 ad.	41,671 \$
129 087 000018	İL-XM67S-220	SABİT İŞİK	TABANA MONTAJ	220V AC	1 ad.	50,600 \$
129 087 000020	İL-XM67F-24	FLAŞÖRLÜ	TABANA MONTAJ	24V AC/DC	1 ad.	52,386 \$
129 087 000023	İL-XM67F-220	FLAŞÖRLÜ	TABANA MONTAJ	220V AC	1 ad.	52,386 \$
129 087 000025	İL-XM67Ç-24	ÇAKAR	TABANA MONTAJ	24V AC/DC	1 ad.	61,911 \$
129 087 000028	İL-XM67Ç-220	ÇAKAR	TABANA MONTAJ	220V AC	1 ad.	61,911 \$
129 087 000030	İL-XM67D-24	DÖNER	TABANA MONTAJ	24V AC/DC	1 ad.	61,911 \$
129 087 000033	İL-XM67D-220	DÖNER	TABANA MONTAJ	220V AC	1 ad.	61,911 \$
129 087 000035	İL-XM67B-24	BUZZER	TABANA MONTAJ	24V AC/DC	1 ad.	34,527 \$
129 087 000038	İL-XM67B-220	BUZZER	TABANA MONTAJ	220V AC	1 ad.	34,527 \$
129 087 000039	İL-XT67-G	GÖVDE			1 ad.	26,788 \$

İL-X.T5 SERİSİ Q 52 1 KATLI İŞIKLI KOLONLAR

129 087 000278	İL-XLS-T5-241	SABİT İŞİK	TABANA MONTAJ	24V DC	1 ad.	29,765 \$
129 087 000279	İL-XLS-T5-2201	SABİT İŞİK	TABANA MONTAJ	220V AC	1 ad.	35,718 \$
129 087 000281	İL-XLF-T5-241	FLAŞÖRLÜ	TABANA MONTAJ	24V DC	1 ad.	45,242 \$
129 087 000282	İL-XLF-T5-2201	FLAŞÖRLÜ	TABANA MONTAJ	220V AC	1 ad.	48,814 \$
129 087 000284	İL-XÇ-T5-241	ÇAKAR	TABANA MONTAJ	24V DC	1 ad.	41,671 \$
129 087 000285	İL-XÇ-T5-2201	ÇAKAR	TABANA MONTAJ	220V AC	1 ad.	47,624 \$
129 087 000287	İL-XLSB-T5-241	SABİT İŞİK+BUZZER	TABANA MONTAJ	24V DC	1 ad.	47,624 \$
129 087 000288	İL-XLSB-T5-2201	SABİT İŞİK+BUZZER	TABANA MONTAJ	220V AC	1 ad.	53,576 \$
129 087 000290	İL-XLFB-T5-241	FLAŞÖRLÜ+BUZZER	TABANA MONTAJ	24V DC	1 ad.	57,148 \$
129 087 000291	İL-XLFB-T5-2201	FLAŞÖRLÜ+BUZZER	TABANA MONTAJ	220V AC	1 ad.	63,101 \$
129 087 000293	İL-XÇB-T5-241	ÇAKAR+BUZZER	TABANA MONTAJ	24V DC	1 ad.	53,576 \$
129 087 000294	İL-XÇB-T5-2201	ÇAKAR+BUZZER	TABANA MONTAJ	220V AC	1 ad.	59,529 \$

İL-X.T5 SERİSİ Q 52 2 KATLI İŞIKLI KOLONLAR

129 087 000296	İL-XLS-T5-242	SABİT İŞİK	TABANA MONTAJ	24V DC	1 ad.	41,671 \$
129 087 000297	İL-XLS-T5-2202	SABİT İŞİK	TABANA MONTAJ	220V AC	1 ad.	44,647 \$
129 087 000299	İL-XLF-T5-242	FLAŞÖRLÜ	TABANA MONTAJ	24V DC	1 ad.	50,005 \$
129 087 000300	İL-XLF-T5-2202	FLAŞÖRLÜ	TABANA MONTAJ	220V AC	1 ad.	56,812 \$
129 087 000302	İL-XLSB-T5-242	SABİT İŞİK+BUZZER	TABANA MONTAJ	24V DC	1 ad.	54,767 \$
129 087 000303	İL-XLSB-T5-2202	SABİT İŞİK+BUZZER	TABANA MONTAJ	220V AC	1 ad.	60,720 \$
129 087 000305	İL-XLFB-T5-242	FLAŞÖRLÜ+BUZZER	TABANA MONTAJ	24V DC	1 ad.	61,911 \$
129 087 000306	İL-XLFB-T5-2202	FLAŞÖRLÜ+BUZZER	TABANA MONTAJ	220V AC	1 ad.	67,864 \$

İL-X.T5 SERİSİ Q 52 3 KATLI İŞIKLI KOLONLAR

129 087 000308	İL-XLS-T5-243	SABİT İŞİK	TABANA MONTAJ	24V DC	1 ad.	44,647 \$
129 087 000309	İL-XLS-T5-2203	SABİT İŞİK	TABANA MONTAJ	220V AC	1 ad.	47,624 \$
129 087 000311	İL-XLF-T5-243	FLAŞÖRLÜ	TABANA MONTAJ	24V DC	1 ad.	57,148 \$
129 087 000312	İL-XLF-T5-2203	FLAŞÖRLÜ	TABANA MONTAJ	220V AC	1 ad.	63,101 \$
129 087 000314	İL-XLSB-T5-243	SABİT İŞİK+BUZZER	TABANA MONTAJ	24V DC	1 ad.	69,054 \$
129 087 000315	İL-XLSB-T5-2203	SABİT İŞİK+BUZZER	TABANA MONTAJ	220V AC	1 ad.	75,007 \$
129 087 000317	İL-XLFB-T5-243	FLAŞÖRLÜ+BUZZER	TABANA MONTAJ	24V DC	1 ad.	75,007 \$
129 087 000318	İL-XLFB-T5-2203	FLAŞÖRLÜ+BUZZER	TABANA MONTAJ	220V AC	1 ad.	80,960 \$

İL-X.T5 SERİSİ Q 52 4 KATLI İŞIKLI KOLONLAR

129 087 000254	İL-XLS-T5-244	SABİT İŞİK	TABANA MONTAJ	24V DC	1 ad.	50,600 \$
129 087 000255	İL-XLS-T5-2204	SABİT İŞİK	TABANA MONTAJ	220V AC	1 ad.	59,529 \$
129 087 000257	İL-XLF-T5-244	FLAŞÖRLÜ	TABANA MONTAJ	24V DC	1 ad.	65,482 \$
129 087 000258	İL-XLF-T5-2204	FLAŞÖRLÜ	TABANA MONTAJ	220V AC	1 ad.	73,816 \$
129 087 000260	İL-XLSB-T5-244	SABİT İŞİK+BUZZER	TABANA MONTAJ	24V DC	1 ad.	77,388 \$
129 087 000261	İL-XLSB-T5-2204	SABİT İŞİK+BUZZER	TABANA MONTAJ	220V AC	1 ad.	85,722 \$
129 087 000263	İL-XLFB-T5-244	FLAŞÖRLÜ+BUZZER	TABANA MONTAJ	24V DC	1 ad.	85,722 \$
129 087 000264	İL-XLFB-T5-2204	FLAŞÖRLÜ+BUZZER	TABANA MONTAJ	220V AC	1 ad.	95,247 \$

İL-X.T5 SERİSİ Q 52 5 KATLI İŞIKLI KOLONLAR

129 087 000266	İL-XLS-T5-245	SABİT İŞİK	TABANA MONTAJ	24V DC	1 ad.	54,767 \$
129 087 000267	İL-XLS-T5-2205	SABİT İŞİK	TABANA MONTAJ	220V AC	1 ad.	64,292 \$
129 087 000269	İL-XLF-T5-245	FLAŞÖRLÜ	TABANA MONTAJ	24V DC	1 ad.	71,435 \$
129 087 000270	İL-XLF-T5-2205	FLAŞÖRLÜ	TABANA MONTAJ	220V AC	1 ad.	92,866 \$
129 087 000272	İL-XLSB-T5-245	SABİT İŞİK+BUZZER	TABANA MONTAJ	24V DC	1 ad.	83,341 \$
129 087 000273	İL-XLSB-T5-2205	SABİT İŞİK+BUZZER	TABANA MONTAJ	220V AC	1 ad.	92,866 \$
129 087 000275	İL-XLFB-T5-245	FLAŞÖRLÜ+BUZZER	TABANA MONTAJ	24V DC	1 ad.	95,247 \$
129 087 000276	İL-XLFB-T5-2205	FLAŞÖRLÜ+BUZZER	TABANA MONTAJ	220V AC	1 ad.	107,153 \$

İL-XB-B SERİSİ Q 67 BORULU KORNALAR

129 087 000230	İL-XB-B-24	KESİK KESİK	95dB/30cm	24V	1 ad.	42,353 \$
129 087 000233	İL-XB-B-220	KESİK KESİK	95dB/30cm	220V	1 ad.	42,353 \$

İL-XB-Q SERİSİ Q 67 KÜBİK KORNALAR

129 087 000235	İL-XB-Q-24	KESİK KESİK	95dB/30cm	24V	1 ad.	42,353 \$
129 087 000238	İL-XB-Q-220	KESİK KESİK	95dB/30cm	220V	1 ad.	42,353 \$

İL-XFM SERİSİ BUZZER

129 087 000245	İL-XFM-12A-905AL70	ÇİFT SES-KABLOLU	90dB/30cm	12V	1 ad.	16,031 \$
129 087 000246	İL-XFM-12Q-905L70	ÇİFT SES-KABLOLU	95dB/60cm	12V	1 ad.	16,031 \$
129 087 000247	İL-XFM-24C-905L70	ÇİFT SES-KABLOLU	92dB/100cm	24V	1 ad.	16,031 \$
129 087 000248	İL-XFM-220A-905AL70	ÇİFT SES-KABLOLU	95dB/30cm	220V	1 ad.	18,900 \$
129 087 000249	İL-XFM-24C-900L700	SÜREKLİ-KABLOLU	92dB/100cm	24V	1 ad.	14,882 \$
129 087 000250	İL-XFM-220A-905A	ÇİFT SES-SOKETLİ	90dB/300cm	12V	1 ad.	18,900 \$
129 087 000251	İL-XFM-12A-905A	ÇİFT SES-SOKETLİ	90dB/30cm	220V	1 ad.	16,031 \$
129 087 000252	İL-XFM-12Q-905	ÇİFT SES-SOKETLİ	90dB/30cm	12V	1 ad.	14,882 \$

İşıklı kolonlarda kırmızı sabit renktir. Diğer renkler siparişle yapılabilmektedir.

Kod	Açıklama / Stok Cinsi	Çalışma Şekli	Montaj Şekli	Besleme Gerilimi	Amb. Birimi	FİYAT
İL-X...-BH SERİSİ MULTİ FONKSİYON AYARLANABİLİR SESLİ İKAZ LAMBALARI						
129 087 000401	İL-XLMB-BH-24X	TEK KATLI	BORULU KORNA	24V DC	1 ad.	39,289\$
129 087 000403	İL-XLMB-BH-220X	TEK KATLI	BORULU KORNA	220V AC	1 ad.	44,201\$
129 087 000405	İL-XLMB-BH-242	İKİ KATLI	BORULU KORNA	24V DC	1 ad.	49,112\$
129 087 000407	İL-XLMB-BH-2202	İKİ KATLI	BORULU KORNA	220V AC	1 ad.	54,023\$
129 087 000409	İL-XMB-BH-243	ÜÇ KATLI	BORULU KORNA	24V DC	1 ad.	58,934\$
129 087 000411	İL-XMB-BH-2203	ÜÇ KATLI	BORULU KORNA	220V AC	1 ad.	63,845\$

İL-X...-QH SERİSİ MULTİ FONKSİYON AYARLANABİLİR SESLİ İKAZ LAMBALARI						
129 087 000400	İL-XLMB-QH-24X	TEK KATLI	KORNA	24V DC	1 ad.	39,289\$
129 087 000402	İL-XLMB-QH-220X	TEK KATLI	KORNA	220V AC	1 ad.	44,201\$
129 087 000404	İL-XLMB-QH-242	İKİ KATLI	KORNA	24V DC	1 ad.	49,112\$
129 087 000406	İL-XLMB-QH-2202	İKİ KATLI	KORNA	220V AC	1 ad.	54,023\$
129 087 000408	İL-XMB-QH-243	ÜÇ KATLI	KORNA	24V DC	1 ad.	58,934\$
129 087 000410	İL-XMB-QH-2203	ÜÇ KATLI	KORNA	220V AC	1 ad.	63,845\$

İL-X-VT6 SERİSİ MULTİ FONKSİYON Q60 İKAZ LAMBALARI						
129 087 000441	İL-XLM-VT6-24K	MULTİ (Sabit-Flaşör-Çakar-Döner)	TABANA MONTAJ	24V DC	1 ad.	47,62\$
129 087 000442	İL-XLM-VT6-220K	MULTİ (Sabit-Flaşör-Çakar-Döner)	TABANA MONTAJ	220V AC	1 ad.	53,58\$
129 087 000443	İL-XLMB-VT6-24K	MULTİ+BUZZER (Sabit-Flaşör-Çakar-Döner)	TABANA MONTAJ	24V DC	1 ad.	53,58\$
129 087 000444	İL-XLMB-VT6-220K	MULTİ+BUZZER (Sabit-Flaşör-Çakar-Döner)	TABANA MONTAJ	220V AC	1 ad.	65,48\$

İL-XV8 SERİSİ MULTİ FONKSİYON Q 84 İKAZ LAMBALARI						
129 087 000445	İL-XLM-V8-24K	MULTİ (Sabit-Flaşör-Çakar-Döner)	VIDALI BAĞLANTI	24V DC	1 ad.	53,58\$
129 087 000446	İL-XLM-V8-220K	MULTİ (Sabit-Flaşör-Çakar-Döner)	VIDALI BAĞLANTI	220V AC	1 ad.	59,53\$
129 087 000447	İL-XLMB-V8-24K	MULTİ+BUZZER (Sabit-Flaşör-Çakar-Döner)	VIDALI BAĞLANTI	24V DC	1 ad.	59,53\$
129 087 000448	İL-XLMB-V8-220K	MULTİ+BUZZER (Sabit-Flaşör-Çakar-Döner)	VIDALI BAĞLANTI	220V AC	1 ad.	65,48\$

İL-X-T8 SERİSİ MULTİ FONKSİYON İKAZ LAMBALARI						
129 087 000449	İL-XLM-T8-24K	MULTİ (Sabit-Flaşör-Çakar-Döner)	TABANA MONTAJ	24V DC	1 ad.	53,58\$
129 087 000450	İL-XLM-T8-220K	MULTİ (Sabit-Flaşör-Çakar-Döner)	TABANA MONTAJ	220V AC	1 ad.	59,53\$
129 087 000451	İL-XLMB-T8-24K	MULTİ+BUZZER (Sabit-Flaşör-Çakar-Döner)	TABANA MONTAJ	24V DC	1 ad.	59,53\$
129 087 000452	İL-XLMB-T8-220K	MULTİ+BUZZER (Sabit-Flaşör-Çakar-Döner)	TABANA MONTAJ	220V AC	1 ad.	65,48\$

İL-X.VT8 SERİSİ MULTİ FONKSİYON Q 84 İKAZ LAMBALARI						
129 087 000453	İL-XLM-VT8-24K	MULTİ (Sabit-Flaşör-Çakar-Döner)	TABAN+VIDALI MON.	24V DC	1 ad.	53,58\$
129 087 000454	İL-XLM-VT8-220K	MULTİ (Sabit-Flaşör-Çakar-Döner)	TABAN+VIDALI MON.	220V AC	1 ad.	59,53\$
129 087 000455	İL-XLMB-VT8-24K	MULTİ+BUZZER (Sabit-Flaşör-Çakar-Döner)	TABAN+VIDALI MON.	24V DC	1 ad.	59,53\$
129 087 000456	İL-XLMB-VT8-220K	MULTİ+BUZZER (Sabit-Flaşör-Çakar-Döner)	TABAN+VIDALI MON.	220V AC	1 ad.	65,48\$

İL-X.VT9 SERİSİ MULTİ FONKSİYON Q 84 İKAZ LAMBALARI						
129 087 000457	İL-XLM-VT9-24K	MULTİ (Sabit-Flaşör-Çakar-Döner)	TABAN+VIDALI MON.	24V DC	1 ad.	44,65\$
129 087 000458	İL-XLM-VT9-220K	MULTİ (Sabit-Flaşör-Çakar-Döner)	TABAN+VIDALI MON.	220V AC	1 ad.	47,62\$
129 087 000459	İL-XLMB-VT9-24K	MULTİ+BUZZER (Sabit-Flaşör-Çakar-Döner)	TABAN+VIDALI MON.	24V DC	1 ad.	47,62\$
129 087 000460	İL-XLMB-VT9-220K	MULTİ+BUZZER (Sabit-Flaşör-Çakar-Döner)	TABAN+VIDALI MON.	220V AC	1 ad.	53,58\$

İL-X.VT10 SERİSİ Q 100 İKAZ LAMBALARI						
129 087 000140	İL-XLS-VT10-24K	SABİT İŞİK	TABANA MONTAJ	24V DC	1 ad.	62,506\$
129 087 000141	İL-XLS-VT10-220K	SABİT İŞİK	TABANA MONTAJ	220V AC	1 ad.	68,459\$
129 087 000143	İL-XLF-VT10-24K	FLAŞÖR	TABANA MONTAJ	24V DC	1 ad.	71,435\$
129 087 000144	İL-XLF-VT10-220K	FLAŞÖR	TABANA MONTAJ	220V AC	1 ad.	80,365\$
129 087 000146	İL-XÇ-VT10-24K	ÇAKAR	TABANA MONTAJ	24V DC	1 ad.	82,151\$
129 087 000147	İL-XÇ-VT10-220K	ÇAKAR	TABANA MONTAJ	220V AC	1 ad.	94,056\$
129 087 000150	İL-XLD-VT10-24K	LEDLİ DÖNER	TABANA MONTAJ	24V DC	1 ad.	82,151\$
129 087 000151	İL-XLD-VT10-220K	LEDLİ DÖNER	TABANA MONTAJ	220V AC	1 ad.	94,056\$
129 087 000153	İL-XLSB-VT10-24K	SABİT İŞİK+BUZZER	TABANA MONTAJ	24V DC	1 ad.	61,911\$
129 087 000154	İL-XLSB-VT10-220K	SABİT İŞİK+BUZZER	TABANA MONTAJ	220V AC	1 ad.	71,435\$
129 087 000156	İL-XLFB-VT10-24K	FLAŞÖRLÜ+BUZZER	TABANA MONTAJ	24V DC	1 ad.	75,007\$
129 087 000157	İL-XLFB-VT10-220K	FLAŞÖRLÜ+BUZZER	TABANA MONTAJ	220V AC	1 ad.	86,913\$
129 087 000159	İL-XÇB-VT10-24K	ÇAKAR+BUZZER	TABANA MONTAJ	24V DC	1 ad.	130,965\$
129 087 000160	İL-XÇB-VT10-220K	ÇAKAR+BUZZER	TABANA MONTAJ	220V AC	1 ad.	142,871\$
129 087 000162	İL-XLDB-VT10-24K	LEDLİ DÖNER+BUZZER	TABANA MONTAJ	24V DC	1 ad.	102,391\$
129 087 000163	İL-XLDB-VT10-220K	LEDLİ DÖNER+BUZZER	TABANA MONTAJ	220V AC	1 ad.	114,296\$

İL-X.VT12 SERİSİ Q 120 İKAZ LAMBALARI						
129 087 000165	İL-XLS-VT12-24K	SABİT İŞİK	TABANA MONTAJ	24V DC	1 ad.	95,247\$
129 087 000166	İL-XLS-VT12-220K	SABİT İŞİK	TABANA MONTAJ	220V AC	1 ad.	107,153\$
129 087 000168	İL-XLF-VT12-24K	FLAŞÖR	TABANA MONTAJ	24V DC	1 ad.	95,247\$
129 087 000169	İL-XLF-VT12-220K	FLAŞÖR	TABANA MONTAJ	220V AC	1 ad.	107,153\$
129 087 000171	İL-XÇ-VT12-24K	ÇAKAR	TABANA MONTAJ	24V DC	1 ad.	95,247\$
129 087 000172	İL-XÇ-VT12-220K	ÇAKAR	TABANA MONTAJ	220V AC	1 ad.	107,153\$
129 087 000175	İL-XLD-VT12-24K	LEDLİ DÖNER	TABANA MONTAJ	24V DC	1 ad.	95,247\$
129 087 000176	İL-XLD-VT12-220K	LEDLİ DÖNER	TABANA MONTAJ	220V AC	1 ad.	107,153\$
129 087 000178	İL-XLSB-VT12-24K	SABİT İŞİK+BUZZER	TABANA MONTAJ	24V DC	1 ad.	95,247\$
129 087 000179	İL-XLSB-VT12-220K	SABİT İŞİK+BUZZER	TABANA MONTAJ	220V AC	1 ad.	107,153\$
129 087 000181	İL-XLFB-VT12-24K	FLAŞÖRLÜ+BUZZER	TABANA MONTAJ	24V DC	1 ad.	105,103\$
129 087 000182	İL-XLFB-VT12-220K	FLAŞÖRLÜ+BUZZER	TABANA MONTAJ	220V AC	1 ad.	113,625\$
129 087 000184	İL-XÇB-VT12-24K	ÇAKAR+BUZZER	TABANA MONTAJ	24V DC	1 ad.	144,061\$
129 087 000185	İL-XÇB-VT12-220K	ÇAKAR+BUZZER	TABANA MONTAJ	220V AC	1 ad.	157,158\$
129 087 000187	İL-XLDB-VT12-24K	LEDLİ DÖNER+BUZZER	TABANA MONTAJ	24V DC	1 ad.	116,678\$
129 087 000188	İL-XLDB-VT12-220K	LEDLİ DÖNER+BUZZER	TABANA MONTAJ	220V AC	1 ad.	130,965\$

RENK SEÇENEKLERİ: İL-XLS-T8-12K ● İL-XLS-T8-12S ● İL-XLS-T8-12Y ● İL-XLS-T8-12M ● İL-XLS-T8-12B ○



- 4 Ayır seçilebilir çalışma şekli
- 8 Farklı seçilebilir ses melodisi
- 0..127 Db ayarlanabilir ses seviyesi

İL-X...VT6 SERİSİ

İL-X...V8 SERİSİ

İL-X...T8 SERİSİ

İL-X...VT8 SERİSİ

İL-X...VT9 SERİSİ

İL-X...VT10 SERİSİ

İL-X...VT12 SERİSİ



**TERMOPLASTİK
BUATLAR ve
PANOLAR**



TERMOPLASTİK BUATLAR VE KOMBİNASYON KUTULARI

 <p>ÜRÜN KODU 001 046 000101 00 00 ÜRÜN ADI 85X85 KARE ANTİGRON BUAT AMBALAJ ADET / KOLİ 10/300 FİYAT 2,222 TL</p>	 <p>ÜRÜN KODU 001 046 071414 00 00 ÜRÜN ADI 140X140X70 TERMOPLASTİK BUAT AMBALAJ ADET / KOLİ 10/80 FİYAT 14.882 TL</p>	 <p>ÜRÜN KODU 001 046 071130 00 17 ÜRÜN ADI 225X311X130 TERMOPLASTİK BUAT AMBALAJ ADET / KOLİ 1/4 FİYAT 34,332 TL</p>
 <p>ÜRÜN KODU 001 046 078080 00 17 ÜRÜN ADI 80X80X48 (7ÇIKIŞLI) TERMOPLASTİK BUAT AMBALAJ ADET / KOLİ 18/216 FİYAT 2,313 TL</p>	 <p>ÜRÜN KODU 001 046 071827 00 17 ÜRÜN ADI 180X270X100 (14ÇIKIŞ) TERMOPLASTİK BUAT AMBALAJ ADET / KOLİ 2/20 FİYAT 21,988 TL</p>	 <p>ÜRÜN KODU 001 046 072698 00 17 ÜRÜN ADI 138X226X98 TERMOPLASTİK BUAT AMBALAJ ADET / KOLİ 1/8 FİYAT 17,048 TL</p>
 <p>ÜRÜN KODU 001 046 078585 00 17 ÜRÜN ADI 85X85X48 TERMOPLASTİK BUAT AMBALAJ ADET / KOLİ 18/216 FİYAT 2,476 TL</p>	 <p>ÜRÜN KODU 001 046 073020 00 00 ÜRÜN ADI 300X200X125 TERMOPLASTİK BUAT AMBALAJ ADET / KOLİ 1/15 FİYAT 45.566 TL</p>	 <p>ÜRÜN KODU 001 046 076131 00 17 ÜRÜN ADI 138X226X131 TERMOPLASTİK BUAT AMBALAJ ADET / KOLİ 1/8 FİYAT 18,776 TL</p>
 <p>ÜRÜN KODU 001 046 070090 00 17 ÜRÜN ADI Ø90 TERMOPLASTİK BUAT AMBALAJ ADET / KOLİ 18/216 FİYAT 2,199 TL</p>	 <p>ÜRÜN KODU 001 046 073525 00 00 ÜRÜN ADI 350X255X125 TERMOPLASTİK BUAT AMBALAJ ADET / KOLİ 1/10 FİYAT 50.008 TL</p>	 <p>ÜRÜN KODU 001 046 072698 00 44 ÜRÜN ADI 138X226X98 (SEFFAF) TERMOPLASTİK BUAT AMBALAJ ADET / KOLİ 1/8 FİYAT 19,917 TL</p>
 <p>ÜRÜN KODU 001 046 071010 00 17 ÜRÜN ADI 110X110X74 (8 ÇIKIŞLI) TERMOPLASTİK BUAT AMBALAJ ADET / KOLİ 10/100 FİYAT 6,016TL</p>	 <p>ÜRÜN KODU 001 046 078226 00 17 ÜRÜN ADI 138X226X127 KOMBİNASYON KUTUSU AMBALAJ ADET / KOLİ 1/8 FİYAT 21,848TL</p>	 <p>ÜRÜN KODU 001 046 076131 00 44 ÜRÜN ADI 138X226X131 (SEFFAF) TERMOPLASTİK BUAT AMBALAJ ADET / KOLİ 1/8 FİYAT 23,389 TL</p>
 <p>ÜRÜN KODU 001 046 071118 00 17 ÜRÜN ADI 110X180X77 (10ÇIKIŞ) TERMOPLASTİK BUAT AMBALAJ ADET / KOLİ 5/60 FİYAT 8,502 TL</p>	 <p>ÜRÜN KODU 001 046 075311 00 17 ÜRÜN ADI 225X311X132 KOMBİNASYON KUTUSU AMBALAJ ADET / KOLİ 1/4 FİYAT 38,085 TL</p>	 <p>ÜRÜN KODU 001 046 071199 00 44 ÜRÜN ADI 225X311X99 (SEFFAF) TERMOPLASTİK BUAT AMBALAJ ADET / KOLİ 1/4 FİYAT 37,535 TL</p>
 <p>ÜRÜN KODU 001 046 071210 00 00 ÜRÜN ADI 125X100X75 TERMOPLASTİK BUAT AMBALAJ ADET / KOLİ 10/80 FİYAT 14.882 TL</p>	 <p>ÜRÜN KODU 001 046 071199 00 17 ÜRÜN ADI 225X311X99 TERMOPLASTİK BUAT AMBALAJ ADET / KOLİ 1/4 FİYAT 31,155 TL</p>	 <p>ÜRÜN KODU 001 046 071130 00 44 ÜRÜN ADI 225X311X130 (SEFFAF) TERMOPLASTİK BUAT AMBALAJ ADET / KOLİ 1/4 FİYAT 39,720 TL</p>

ALEV YAYMAYAN TERMOPLASTİK BUATLAR VE KOMBİNASYON KUTULARI

 <p>ÜRÜN KODU 001 046 098080 00 17 ÜRÜN ADI 80X80X48 (7ÇIKIŞLI) TERMOPLASTİK BUAT (GRİ) (A. YAYMAYAN) AMBALAJ ADET / KOLİ 18/216 FİYAT 4,589 TL</p>	 <p>ÜRÜN KODU 001 046 098226 00 17 ÜRÜN ADI 138X226X127 KOMBİNASYON KUTUSU (A. YAYMAYAN) AMBALAJ ADET / KOLİ 1/8 FİYAT 32,435 TL</p>	 <p>ÜRÜN KODU 001 046 092698 00 44 ÜRÜN ADI 138X226X98 (ŞEFFAF) TERMOPLASTİK BUAT (A. YAYMAYAN) AMBALAJ ADET / KOLİ 1/8 FİYAT 26,131 TL</p>
 <p>ÜRÜN KODU 001 046 098585 00 17 ÜRÜN ADI 85X85X48 TERMOPLASTİK BUAT (GRİ) (A. YAYMAYAN) AMBALAJ ADET / KOLİ 18/216 FİYAT 3,650 TL</p>	 <p>ÜRÜN KODU 001 046 095311 00 17 ÜRÜN ADI 225X311X132 KOMBİNASYON KUTUSU (A. YAYMAYAN) AMBALAJ ADET / KOLİ 1/4 FİYAT 56,182 TL</p>	 <p>ÜRÜN KODU 001 046 096131 00 44 ÜRÜN ADI 138X226X131(ŞEFFAF) TERMOPLASTİK BUAT (A. YAYMAYAN) AMBALAJ ADET / KOLİ 1/8 FİYAT 28.656 TL</p>
 <p>ÜRÜN KODU 001 046 090090 00 17 ÜRÜN ADI Ø90 TERMOPLASTİK BUAT (GRİ) (A. YAYMAYAN) AMBALAJ ADET / KOLİ 18/216 FİYAT 2,379 TL</p>	 <p>ÜRÜN KODU 001 046 091199 00 17 ÜRÜN ADI 225X311X99 TERMOPLASTİK BUAT (A. YAYMAYAN) AMBALAJ ADET / KOLİ 1/4 FİYAT 47,659 TL</p>	 <p>ÜRÜN KODU 001 046 091199 00 44 ÜRÜN ADI 225X311X99 (ŞEFFAF) TERMOPLASTİK BUAT (A. YAYMAYAN) AMBALAJ ADET / KOLİ 1/4 FİYAT 48,291 TL</p>
 <p>ÜRÜN KODU 001 046 091010 00 17 ÜRÜN ADI 110X110X74 (8ÇIKIŞLI) TERMOPLASTİK BUAT (A.YAYMAYAN) AMBALAJ ADET / KOLİ 10/100 FİYAT 13,806 TL</p>	 <p>ÜRÜN KODU 001 046 091130 00 17 ÜRÜN ADI 225X311X130 TERMOPLASTİK BUAT (A. YAYMAYAN) AMBALAJ ADET / KOLİ 1/4 FİYAT 53,055 TL</p>	 <p>ÜRÜN KODU 001 046 091130 00 44 ÜRÜN ADI 225X311X130 (ŞEFFAF) TERMOPLASTİK BUAT (A. YAYMAYAN) AMBALAJ ADET / KOLİ 1/4 FİYAT 46.472 TL</p>
 <p>ÜRÜN KODU 001 046 091118 00 17 ÜRÜN ADI 110X180X77 (10 ÇIK.) TERMOPLASTİK BUAT (GRİ) (A.YAYMAYAN) AMBALAJ ADET / KOLİ 5/60 FİYAT 21,770 TL</p>	 <p>ÜRÜN KODU 001 046 092698 00 17 ÜRÜN ADI 138X226X98 TERMOPLASTİK BUAT (A. YAYMAYAN) AMBALAJ ADET / KOLİ 1/8 FİYAT 23,399 TL</p>	
 <p>ÜRÜN KODU 001 046 091827 00 17 ÜRÜN ADI 180X270X100 (14ÇIK.) TERMOPLASTİK BUAT (A.YAYMAYAN)(GRİ) AMBALAJ ADET / KOLİ 2/20 FİYAT 55,634 TL</p>	 <p>ÜRÜN KODU 001 046 096131 00 17 ÜRÜN ADI 138X226X131 TERMOPLASTİK BUAT (A. YAYMAYAN) AMBALAJ ADET / KOLİ 1/8 FİYAT 30,265 TL</p>	



Kod	Açıklama / Stok Cinsi	Amb. (Kutu/Bağ)	Amb. (Koli/Çi.)	FİYAT
PLASTİK OPAK KAPAKLI PANOLARI				
048 090 203013	20X30X13 PLASTİK OPAK KAPAKLI PANO	1 ad.		56,824
048 090 253515	25X35X15 PLASTİK OPAK KAPAKLI PANO	1 ad.		68,188
048 090 304017	30X40X17 PLASTİK OPAK KAPAKLI PANO	1 ad.		88,076
048 090 304022	30X40X22 PLASTİK OPAK KAPAKLI PANO	1 ad.		110,806
048 090 355019	35X50X19 PLASTİK OPAK KAPAKLI PANO	1 ad.		125,012
048 090 405018	40X50X18 PLASTİK OPAK KAPAKLI PANO	1 ad.		142,059
048 090 405024	40X50X24 PLASTİK OPAK KAPAKLI PANO	1 ad.		153,424
048 090 406020	40X60X20 PLASTİK OPAK KAPAKLI PANO	1 ad.		159,106
048 090 507025	50X70X25 PLASTİK OPAK KAPAKLI PANO	1 ad.		289,800
048 090 608026	60X80X26 PLASTİK OPAK KAPAKLI PANO	1 ad.		511,412

PLASTİK ŞEFFAF KAPAKLI PANOLARI

048 088 203013	20X30X13 PLASTİK ŞEFFAF KAPAKLI PANO	1 ad.		71,029
048 088 253515	25X35X15 PLASTİK ŞEFFAF KAPAKLI PANO	1 ad.		85,235
048 088 304017	30X40X17 PLASTİK ŞEFFAF KAPAKLI PANO	1 ad.		107,965
048 088 304022	30X40X22 PLASTİK ŞEFFAF KAPAKLI PANO	1 ad.		130,694
048 088 355019	35X50X19 PLASTİK ŞEFFAF KAPAKLI PANO	1 ad.		147,741
048 088 405018	40X50X18 PLASTİK ŞEFFAF KAPAKLI PANO	1 ad.		170,471
048 088 405024	40X50X24 PLASTİK ŞEFFAF KAPAKLI PANO	1 ad.		181,835
048 088 406020	40X60X20 PLASTİK ŞEFFAF KAPAKLI PANO	1 ad.		193,200
048 088 507025	50X70X25 PLASTİK ŞEFFAF KAPAKLI PANO	1 ad.		355,147
048 088 608026	60X80X26 PLASTİK ŞEFFAF KAPAKLI PANO	1 ad.		596,647

POLYESTER ETANJ PANOLAR (POSEL)

009 089 001510	S/A TEKLI SAYAÇ PANOSU MONOFAZE	1 ad.	20	54,693
009 089 152011	15X20X11 POLYESTER ETANJ PANO	1 ad.	12	48,442
009 089 162610	16X26X10 POLYESTER ETANJ PANO	1 ad.	20	46,879
009 089 202517	20X25X17 POLYESTER ETANJ PANO	1 ad.	10	70,319
009 089 202512	20X25X12 POLYESTER ETANJ PANO	1 ad.	12	70,319
009 089 203017	30X20X17 POLYESTER ETANJ PANO	1 ad.	8	73,444
009 089 203012	30X20X12 POLYESTER ETANJ PANO	1 ad.	12	73,444
009 089 253017	25X30X17 POLYESTER ETANJ PANO	1 ad.	6	82,820
009 089 253012	25X30X12 POLYESTER ETANJ PANO	1 ad.	6	82,820
009 089 304017	30X40X17 POLYESTER ETANJ PANO	1 ad.	4	106,260
009 089 304012	30X40X12 POLYESTER ETANJ PANO	1 ad.	5	106,260
009 089 355022	35X50X22 POLYESTER ETANJ PANO	1 ad.	3	156,265
009 089 355017	35X50X17 POLYESTER ETANJ PANO	1 ad.	3	156,265
009 089 406022	40X60X22 POLYESTER ETANJ PANO	1 ad.	3	159,390
009 089 406017	40X60X17 POLYESTER ETANJ PANO	1 ad.	3	159,390
009 089 406027	40X60X27 POLYESTER ETANJ PANO	1 ad.	2	187,518
009 089 508022	50X80X22 POLYESTER ETANJ PANO	1 ad.	1	387,536
009 089 508027	50X80X27 POLYESTER ETANJ PANO	1 ad.	1	387,536
009 089 508032	50X80X32 POLYESTER ETANJ PANO	1 ad.	1	387,536
009 089 701001	70X100X33 POLYESTER ETANJ PANO (TEK KAPI)	1 ad.	1	1.340,751
009 089 701002	70X100X33 POLYESTER ETANJ PANO (ÇİFT KAPI)	1 ad.	1	1.340,751

LOGAR KUTUSU

074 048 622020	20X20 LOGAR KUTUSU TAKIM	1 ad.		20,406
074 048 623030	30X30 LOGAR KUTUSU TAKIM	1 ad.		41,671
074 048 624040	40X40 LOGAR KUTUSU TAKIM	2 ad.		79,174
074 048 625050	50X50 LOGAR KUTUSU TAKIM	1 ad.		160,587
074 048 625555	55X55 LOGAR KUTUSU TAKIM	1 ad.		240,880





**SANAYİ
TİPİ
ÜRÜNLER**



KOMBİNASYON KUTULARI



ÜRÜN KODU
001 046 075130 00 17
ÜRÜN ADI
1-Lİ KOMBİNASYON KUT.
(BOŞ)(215X130)GRİ
AMBALAJ ADET / KOLİ
1/10
FİYAT
20,240TL



ÜRÜN KODU
001 046 070220 00 17
ÜRÜN ADI
2-Lİ KOMBİNASYON KUT.
(BOŞ)(290X220)GRİ
AMBALAJ ADET / KOLİ
1/4
FİYAT
28,276 TL

MUTLUSAN SANAYİ FİŞ-PRİZ GRUBU (MONOFAZE 1X16 A.)



ÜRÜN KODU
010 083 500298
ÜRÜN ADI
MUT-298 MONOFAZE
TOPRAKLI PANO PRİZİ
AMBALAJ ADET / KOLİ
40/320
FİYAT
4,735 TL



ÜRÜN KODU
010 083 501297
ÜRÜN ADI
MUT-298-U MONOFAZE
UPS TOP. PANO PRİZİ
AMBALAJ ADET / KOLİ
30/240
FİYAT
8,118 TL



ÜRÜN KODU
010 083 500297
ÜRÜN ADI
MUT-297 MONO.DUVAR
PRİZİ (PLASTİK)
AMBALAJ ADET / KOLİ
30/240
FİYAT
10,521 TL



ÜRÜN KODU
010 083 500299
ÜRÜN ADI
MUT-299 MONO.
MAKİNA PRİZİ
AMBALAJ ADET / KOLİ
20/160
FİYAT
10,060 TL



ÜRÜN KODU
010 083 502910
ÜRÜN ADI
MUT-2910 MONO.
DUVAR PRİZİ
AMBALAJ ADET / KOLİ
15/120
FİYAT
14,287 TL

MUTLUSAN SANAYİ FİŞ-PRİZ GRUBU (TRİFAZE 3X16 A.)



ÜRÜN KODU
010 083 400064
ÜRÜN ADI
MUT-64 3X16 TRİFAZE
MAKİNE PRİZİ (PLS.)
AMBALAJ ADET / KOLİ
20/160
FİYAT
14,882 TL



ÜRÜN KODU
010 083 400063
ÜRÜN ADI
MUT-63 3X16 TRİFAZE
DUVAR PRİZİ (PLS.)
AMBALAJ ADET / KOLİ
12/96
FİYAT
17,859 TL

MUTLUSAN SANAYİ FİŞ-PRİZ GRUBU (TRİFAZE 3X25 A.)



ÜRÜN KODU
010 083 400318
ÜRÜN ADI
MUT-318 3X25 TRİFAZE
MAKİNE PRİZİ (PLASTİK)
AMBALAJ ADET / KOLİ
20/160
FİYAT
11,459 TL



ÜRÜN KODU
010 083 400319
ÜRÜN ADI
MUT-319 3X25 TRİFAZE
DUVAR PRİZİ (PLASTİK)
AMBALAJ ADET / KOLİ
15/120
FİYAT
17,264 TL

MUTLUSAN SANAYİ FİŞ-PRİZ GRUBU (TRİFAZE 3X25 A.)



ÜRÜN KODU
010 083 400074
ÜRÜN ADI
MUT-74 3X32 TRİFAZE
MAKİNE PRİZİ (PLS.)
AMBALAJ ADET / KOLİ
20/160
FİYAT
15,865 TL



ÜRÜN KODU
010 083 400073
ÜRÜN ADI
MUT-73 3X32 TRİFAZE
DUVAR PRİZİ (PLS.)
AMBALAJ ADET / KOLİ
12/96
FİYAT
20,835 TL

MUTLUSAN CEE NORM SANAYİ TİPİ FİŞ ve PRİZLER

ÜRÜN KODU
010 083 000516
ÜRÜN ADI
MUT-101 CEE NORM
5X16 A DÜZ FİŞ
AMBALAJ ADET / KOLİ
16/128
FİYAT
17,859 TL



ÜRÜN KODU
010 083 000532
ÜRÜN ADI
MUT-201 CEE NORM
5X32 A DÜZ FİŞ
AMBALAJ ADET / KOLİ
15/120
FİYAT
23,812 TL



ÜRÜN KODU
010 083 010516
ÜRÜN ADI
MUT-102 CEE NORM
5X16 A UZATMA PRİZİ
AMBALAJ ADET / KOLİ
15/120
FİYAT
23,812 TL



ÜRÜN KODU
010 083 010532
ÜRÜN ADI
MUT-202 CEE NORM
5X32 A UZATMA PRİZİ
AMBALAJ ADET / KOLİ
14/112
FİYAT
29,765 TL



ÜRÜN KODU
010 083 020516
ÜRÜN ADI
MUT-103 CEE NORM
5X16 A MAKİNE PRİZİ
AMBALAJ ADET / KOLİ
20/160
FİYAT
22,621 TL



ÜRÜN KODU
010 083 020532
ÜRÜN ADI
MUT-203 CEE NORM
5X32 A MAKİNE PRİZİ
AMBALAJ ADET / KOLİ
14/112
FİYAT
27,979 TL



ÜRÜN KODU
010 083 030516
ÜRÜN ADI
MUT-104 CEE NORM
5X16 A DUVAR PRİZİ
AMBALAJ ADET / KOLİ
8/64
FİYAT
29,765 TL



ÜRÜN KODU
010 083 030532
ÜRÜN ADI
MUT-204 CEE NORM
5X32 A DUVAR PRİZİ
AMBALAJ ADET / KOLİ
8/64
FİYAT
34,229 TL

MUTLUSAN SANAYİ FİŞ-PRİZ GRUBU (TRİFAZE 3X16 A.)

ÜRÜN KODU
010 083 400060
ÜRÜN ADI
MUT-60 3X16 TRİFAZE
ERKEK FİŞ
AMBALAJ ADET / KOLİ
30/240
FİYAT
15,478 TL



ÜRÜN KODU
010 083 400061
ÜRÜN ADI
MUT-61 3X16 TRİFAZE
SEYYAR DİŞİ FİŞ
AMBALAJ ADET / KOLİ
25/200
FİYAT
19,347 TL



ÜRÜN KODU
010 083 400062
ÜRÜN ADI
MUT-62 3X16 TRİFAZE
DUVAR PRİZİ
AMBALAJ ADET / KOLİ
20/160
FİYAT
22,621 TL

MUTLUSAN SANAYİ FİŞ-PRİZ GRUBU (TRİFAZE 3X32 A.)

ÜRÜN KODU
010 083 400070
ÜRÜN ADI
MUT-70 3X32 TRİFAZE
ERKEK FİŞ
AMBALAJ ADET / KOLİ
20/160
FİYAT
23,365 TL



ÜRÜN KODU
010 083 400071
ÜRÜN ADI
MUT-71 3X32 TRİFAZE
SEYYAR DİŞİ FİŞ
AMBALAJ ADET / KOLİ
20/160
FİYAT
27,384 TL



ÜRÜN KODU
010 083 400072
ÜRÜN ADI
MUT-72 3X32 TRİFAZE
DUVAR PRİZİ
AMBALAJ ADET / KOLİ
20/160
FİYAT
34,110 TL

MUTLUSAN SANAYİ FİŞ-PRİZ GRUBU (MONOFAZE 1X16 A.)

 <p>ÜRÜN KODU 010 083 300027 ÜRÜN ADI MUT-27 1X16 A. MONO. TOP. ERKEK FİŞ(EĞİK) AMBALAJ ADET / KOLİ 50/400 FİYAT 4,465 TL</p>	 <p>ÜRÜN KODU 010 083 300028 ÜRÜN ADI MUT-28 1X16 A. MONO. TOP. ERKEK FİŞ(DÜZ) AMBALAJ ADET / KOLİ 50/400 FİYAT 4,465 TL</p>	 <p>ÜRÜN KODU 010 083 300029 ÜRÜN ADI MUT-29 1X16 A. MONO. TOPRAKLI DİŞİ FİŞ AMBALAJ ADET / KOLİ 30/240 FİYAT 8,929 TL</p>
 <p>ÜRÜN KODU 010 083 500296 ÜRÜN ADI MUT-296 1X16 A. MONO. TOP. DUVAR PRİZ AMBALAJ ADET / KOLİ 20/160 FİYAT 11,311 TL</p>	 <p>ÜRÜN KODU 010 083 500293 ÜRÜN ADI MUT-293 1X16 A. MONO. 3'LÜ GRUP PRİZ AMBALAJ ADET / KOLİ 12/96 FİYAT 15,559 TL</p>	 <p>ÜRÜN KODU 010 083 500294 ÜRÜN ADI MUT-294 1X16 A. MONO. 4'LÜ GRUP PRİZ AMBALAJ ADET / KOLİ 12/96 FİYAT 22,621 TL</p>
 <p>ÜRÜN KODU 010 083 501292 ÜRÜN ADI MUT-292A 1X16 A. MONO. 2'Lİ GR. PRİZ ANH. AMBALAJ ADET / KOLİ 12/96 FİYAT 23,216 TL</p>	 <p>ÜRÜN KODU 010 083 501293 ÜRÜN ADI MUT-293A 1X16 A. MONO. 3'LÜ GR. PRİZ ANH. AMBALAJ ADET / KOLİ 10/80 FİYAT 24,353 TL</p>	 <p>ÜRÜN KODU 010 083 500292 ÜRÜN ADI MUT-292 1X16 A. MONO. 2'Lİ GRUP PRİZ AMBALAJ ADET / KOLİ 12/96 FİYAT 14,287 TL</p>

MUTLUSAN SANAYİ FİŞ-PRİZ GRUBU (TRİFAZE 3X25 A.)

 <p>ÜRÜN KODU 010 083 400030 ÜRÜN ADI MUT-30 3X25 TRİFAZE ERKEK FİŞ AMBALAJ ADET / KOLİ 30/240 FİYAT 8,929 TL</p>	 <p>ÜRÜN KODU 010 083 400031 ÜRÜN ADI MUT-31 3X25 TRİFAZE DİŞİ FİŞ (SEYYAR) AMBALAJ ADET / KOLİ 20/160 FİYAT 14,138 TL</p>	 <p>ÜRÜN KODU 010 083 600315 ÜRÜN ADI MUT-315 3X25 TRİFAZE DUVAR PRİZİ AMBALAJ ADET / KOLİ 20/160 FİYAT 17,264 TL</p>
 <p>ÜRÜN KODU 010 083 600311 ÜRÜN ADI MUT-311 1 TRİFAZE 1 MONOFAZE GRUP PRİZ AMBALAJ ADET / KOLİ 10/80 FİYAT 32,741 TL</p>	 <p>ÜRÜN KODU 010 083 600312 ÜRÜN ADI MUT-312 TRİFAZE 2'Lİ GRUP PRİZ AMBALAJ ADET / KOLİ 10/80 FİYAT 34,527 TL</p>	 <p>ÜRÜN KODU 010 083 600313 ÜRÜN ADI MUT-313 TRİFAZE 3'LÜ GRUP PRİZ AMBALAJ ADET / KOLİ 10/80 FİYAT 47,624 TL</p>
 <p>ÜRÜN KODU 010 083 600316 ÜRÜN ADI MUT-316. 2 TRİFAZE+1 MONOFAZE GRUP PRİZ AMBALAJ ADET / KOLİ 10/80 FİYAT 44,647 TL</p>	 <p>ÜRÜN KODU 010 083 600317 ÜRÜN ADI MUT-317 1 TRİFAZE+2 MONOFAZE GRUP PRİZ AMBALAJ ADET / KOLİ 8/64 FİYAT 41,671 TL</p>	



Kod	Açıklama / Stok Cinsi	Amb. (Kutu/Bağ)	Amb. (Koli/Çift)	FİYAT
0,6-1 KV BAKIR İLETKENLER İÇİN REÇİNELİ EK MUFLAR				
052 125 010019	E1 404-E1 406 (4X4-4X6)	1 ad.		48,711
052 125 010020	E1 410 (4X10)	1 ad.		75,576
052 125 010022	E1 416 (4X16)	1 ad.		77,207
052 125 010033	E1 31610 (3X16+10)	1 ad.		76,508
052 125 010034	E1 32516 (3X25+16)	1 ad.		80,520
052 125 010035	E1 33516 (3X35+16)	1 ad.		84,558
052 125 010036	E1 35025 (3X50+25)	1 ad.		88,104
052 125 010037	E1 37035 (3X70+35)	1 ad.		140,904
052 125 010038	E1 39550 (3X95+50)	1 ad.		147,607
052 125 010039	E1 31207 (3X120+70)	1 ad.		234,908
052 125 010040	E1 31507 (3X150+70)	1 ad.		245,727
052 125 010041	E1 31859 (3X185+95)	1 ad.		362,301
052 125 010042	E1 32401 (3X240+120)	1 ad.		379,306
PROTOLİN (REÇİNE)				
052 125 030200	PRO 210 GR. PROTOLİN REÇİNE	1 ad.		16,824
052 125 030500	PRO 500 GR. PROTOLİN REÇİNE	1 ad.		27,570
052 125 031000	PRO 1000 GR. PROTOLİN REÇİNE	1 ad.		49,415
052 125 031500	PRO 1500 GR. PROTOLİN REÇİNE	1 ad.		74,438
052 125 033000	PRO 3 KG PROTOLİN REÇİNE	1 ad.		148,875
052 125 030040	PRO 4 KG PROTOLİN REÇİNE	1 ad.		172,791
052 125 030020	PRO 20 KG PROTOLİN REÇİNE	1 ad.		845,473
0.6-1 kv A.G. PAPUÇSUZ REÇİNELİ KABLO BAŞLIKLARI				
052 125 070001	PKB 01 (2X1,5-3X50+25)	1 ad.		19,800
052 125 070002	PKB 02 (3X70+35-3X95+50)	1 ad.		28,289
052 125 070003	PKB 03 (3X120+70-3X150+70)	1 ad.		49,487
0.6-1 kv BAKIR İLETKENLER İÇİN ISI BÜZÜŞMELİ EK MUFLARI				
052 125 020011	S1 404-S1 406 (4X4-4X6) ISI BÜZÜŞMELİ	1 ad.		23,631
052 125 020001	S1 410 (4X10) ISI BÜZÜŞMELİ	1 ad.		29,713
052 125 020002	S1 416 (4X16) ISI BÜZÜŞMELİ	1 ad.		31,473
052 125 120425	S1 425 (4X25) ISI BÜZÜŞMELİ	1 ad.		48,504
052 125 120435	S1 435 (4X35) ISI BÜZÜŞMELİ	1 ad.		52,179
052 125 120450	S1 450 (4X50) ISI BÜZÜŞMELİ	1 ad.		56,424
052 125 120470	S1 470 (4X70) ISI BÜZÜŞMELİ	1 ad.		83,704
052 125 120495	S1 495 (4X95) ISI BÜZÜŞMELİ	1 ad.		91,908
052 125 020003	S1 31610 (3X16+10) ISI BÜZÜŞMELİ	1 ad.		31,473
052 125 020004	S1 32616 (3X25+16) ISI BÜZÜŞMELİ	1 ad.		45,553
052 125 020005	S1 33516 (3X35+16) ISI BÜZÜŞMELİ	1 ad.		50,911
052 125 020006	S1 35025 (3X50+25) ISI BÜZÜŞMELİ	1 ad.		54,871
052 125 020007	S1 37035 (3X70+35) ISI BÜZÜŞMELİ	1 ad.		82,228
052 125 020008	S1 39550 (3X95+50) ISI BÜZÜŞMELİ	1 ad.		94,885
052 125 020009	S1 31207 (3X120+70) ISI BÜZÜŞMELİ	1 ad.		117,144
052 125 020027	S1 31507 (3X150+70) ISI BÜZÜŞMELİ	1 ad.		144,501
052 125 020010	S1 31859 (3X185+95) ISI BÜZÜŞMELİ	1 ad.		235,685
052 125 020028	S1 32401 (3X240+120) ISI BÜZÜŞMELİ	1 ad.		246,581
ISI İLE DARALAN MAKARONLAR				
065 141 030001	1,5 MM ISI İLE DARALAN MAKARON	200 mt.		0,112 \$
065 141 030002	2,5 MM ISI İLE DARALAN MAKARON	200 mt.		0,129 \$
065 141 030003	3 MM ISI İLE DARALAN MAKARON	200 mt.		0,151 \$
065 141 030004	3,2 MM ISI İLE DARALAN MAKARON	200 mt.		0,151 \$
065 141 030005	3,5 MM ISI İLE DARALAN MAKARON	200 mt.		0,158 \$
065 141 030006	4 MM ISI İLE DARALAN MAKARON	200 mt.		0,172 \$
065 141 030007	4,5 MM ISI İLE DARALAN MAKARON	100 mt.		0,189 \$
065 141 030008	4,8 MM ISI İLE DARALAN MAKARON	100 mt.		0,189 \$
065 141 030009	5 MM ISI İLE DARALAN MAKARON	100 mt.		0,206 \$
065 141 030010	6 MM ISI İLE DARALAN MAKARON	100 mt.		0,223 \$
065 141 030011	6,4 MM ISI İLE DARALAN MAKARON	100 mt.		0,223 \$
065 141 030012	7 MM ISI İLE DARALAN MAKARON	100 mt.		0,246 \$
065 141 030013	8 MM ISI İLE DARALAN MAKARON	100 mt.		0,266 \$
065 141 030014	9,5 MM ISI İLE DARALAN MAKARON	100 mt.		0,275 \$
065 141 030015	10 MM ISI İLE DARALAN MAKARON	100 mt.		0,292 \$
065 141 030016	12,7 MM ISI İLE DARALAN MAKARON	100 mt.		0,361 \$
065 141 030017	13 MM ISI İLE DARALAN MAKARON	100 mt.		0,395 \$
065 141 030018	16 MM ISI İLE DARALAN MAKARON	100 mt.		0,688 \$
065 141 030019	18 MM ISI İLE DARALAN MAKARON	100 mt.		0,859 \$
065 141 030020	19,1 MM ISI İLE DARALAN MAKARON	100 mt.		1,014 \$
065 141 030021	20 MM ISI İLE DARALAN MAKARON	100 mt.		1,014 \$
065 141 030022	22 MM ISI İLE DARALAN MAKARON	100 mt.		1,169 \$
065 141 030023	25 MM ISI İLE DARALAN MAKARON	50 mt.		1,238 \$
065 141 030024	30 MM ISI İLE DARALAN MAKARON	50 mt.		2,235 \$
065 141 030025	35 MM ISI İLE DARALAN MAKARON	25 mt.		2,836 \$
065 141 030026	40 MM ISI İLE DARALAN MAKARON	25 mt.		2,922 \$
065 141 030027	50 MM ISI İLE DARALAN MAKARON	25 mt.		4,297 \$
065 141 030028	60 MM ISI İLE DARALAN MAKARON	20 mt.		6,188 \$
065 141 030029	70 MM ISI İLE DARALAN MAKARON	20 mt.		8,251 \$
065 141 030030	80 MM ISI İLE DARALAN MAKARON	20 mt.		9,454 \$
065 141 030031	90 MM ISI İLE DARALAN MAKARON	20 mt.		11,001 \$
065 141 030032	100 MM ISI İLE DARALAN MAKARON	20 mt.		11,173 \$
065 141 030033	120 MM ISI İLE DARALAN MAKARON	20 mt.		17,189 \$

HAYATINIZI RİSKE ATMAYIN

Evinizde, işyerinizde, okulunuzda, fabrikanızda... Hayatın her anında hayatınızı riske atmayın...
Mutlusan Sigorta Kutusu ürünlerimizi kullanın, geleceğe güvenli bakın...



COMFORT



Mutlusan Plastik Elektrik Tic. ve San. A.Ş.

İkitelli Org.San. Bölgesi Mahallesi Enkoop Cad.
No:7 Başakşehir- İstanbul
Tel : +90 (212) 485 05 44 (PBX)
Faks : +90 (212) 485 10 12

Karaköy Şube

Okçumusa Cad. Güneşan İş Hanı No : 24/10
Karaköy-İstanbul
Tel : +90 (212) 237 06 02 (PBX)
Fax: +90 (212) 237 77 47

Perpa Şube

Perpa Tic. Merkezi. A Blok Kat: 2
No: 9-009 Okmeydanı - İstanbul
Tel : +90 (212) 320 05 78 (PBX)
Fax: +90 (212) 320 05 81



mutlusan.com.tr